



HP 15c Collector's Edition SCIENTIFIC CALCULATOR



OWNER'S HANDBOOK



HP 15c Collector's Edition Owner's Handbook

Edition 3, February 2023

Acknowledgements

Manufacturer would like to thank the following for their contribution:

José González Divassón, Włodek Mier-Jędrzejowicz, Bob Prospero,
Eric Rechlin, Jake Schwartz, Namir Shamma, and Gene Wright

Introduction

Congratulations! You hold in your hands one of the most capable calculators HP has ever made—the classic HP-15C, reissued and updated as the HP 15c Collector’s Edition, the HP 15c CE. Let’s look at how this device came to be and why its features remain in demand even today.

The Story of HP Calculators

HP introduced the world’s first scientific, pocket calculator, the HP-35, on February 1, 1972. Single-handedly, it altered forever the market for tools such as slide rules, books of tables, and mechanical calculators. This calculating tool computed sine, cosine, and tangent in degrees as well as logarithms and powers. It also featured an independent memory register allowing a value to be reused. The initial version, highly prized by collectors, had a small red dot that appeared next to the power switch whenever the calculator was turned on. This was removed fairly soon after introduction, since it was obvious the machine was on for two other reasons: the on/off switch would be in the ON position and the display would be showing a number in the red light-emitting diode (LED) display if the batteries were not yet discharged. For this reason, there are not many of these early models available and they command quite a price among collectors.



HP-35

Notably, the HP-35 used Reverse Polish Notation (RPN), allowing problems to be solved without the need for parentheses or remembering pending operations. RPN accomplished this on the HP-35 by using a 4-level stack where intermediate results are available and, on later models, a fifth register named LAST X facilitating error recovery during a calculation. Numbers were keyed in and separated using an **ENTER** key. No equals key was to be found anywhere on the keyboard.

The ease of use that RPN brought to problem solving is sometimes lost on users today, with huge storage space and processing speeds in the gigahertz range, but it was an incredible advance at the time. For example, consider the fairly simple problem: $(4 + 3) \div (2 + 1) = ?$

ii Introduction

In RPN, the solution is to begin at the innermost set of two numbers and proceed outward. The solution $4 \text{ [ENTER]} 3 \text{ [+]} 2 \text{ [ENTER]} 1 \text{ [+]} \text{ [÷]}$ displays the answer of 2.3333 using 9 keystrokes. Competing calculators of its day and even for several years afterward that did not use RPN could not solve this problem readily without a lot of parentheses. In RPN, all problems are solved with the same approach. If you are not familiar with RPN already, time spent with that portion of this HP 15c CE manual will pay many benefits in the future.

HP continued to introduce more capable and updated scientific models over the next few years, such as the HP-45 introduced on May 1, 1973, which added some statistical functions, conversions and multiple angular modes for trigonometry, followed by the HP-21, introduced on February 1, 1975, which provided the same capabilities as the HP-35 in a smaller-sized calculator at one third the cost, a mere three years after the debut of the HP-35.

HP also introduced a range of business models, such as the HP-80, the HP-70, and the HP-22. These models revolutionized financial and business calculations as much as their scientific models changed the world for scientific and technical users, since it was now possible to solve problems such as ones involving the time value of money on a handheld calculator.

Another revolutionary device developed by HP was the HP-65 fully programmable pocket calculator, introduced on January 19, 1974. Known internally at HP by the code name “Superstar”, it was truly a game changer. The HP-65 featured a large number of scientific functions, but also provided users with the option to write programs to solve new problems and add new functions to the machine, which could be recorded and saved on magnetic cards, so that the calculator and also your cards with programs and data recorded on them could all be carried with you and could even fit in a large pocket. The 100-step program memory was huge for the time and, even then, program execution could be extended by reading successive program cards into the calculator for further processing. HP-65 users were able to submit programs they had created to the HP-65



HP-65

Users' Library where they could be shared with other users. Well over 5500 programs were submitted to the library and made available to its members for a nominal fee. In addition, a large number of books were written, some about techniques to use on various calculator models, but others focused on

solutions to problems in specific fields, such as navigation, astronomy, statistics, and mathematics.

The paradigm shift created by the ability to develop your own solutions to problems and apply them away from big corporate computers was not lost on users of HP calculators. One such user, Richard Nelson, formed the HP-65 Users Club and began publishing a monthly journal, initially called 65 Notes. This journal focused on documenting shorter or faster ways of solving problems manually or with a program and got larger every month as members of the club began submitting programs or routines they had developed to share with others. The first programs published included computing hyperbolic functions and their inverses while a second set used undocumented program pointer techniques to expand the user-defined function keys beyond the five keys at the top of the HP-65, labeled A through E. The club later became known as PPC (Personal Programming Center), publishing the now-renamed PPC Journal, and remained active for well over 10 years, even creating their own custom plug-in module for a later HP calculator model. With each new HP calculator introduced, the club sought to find new ways to extend functionality, especially through undocumented features, and to apply these machines to new problems as power increased.

The HP-65 was followed by the fully programmable HP-67, and its desktop sibling, the HP-97, on July 1, 1976. In some ways, however, these were more extensions of the HP-65 than a new direction. They provided 224 program steps, each of which could merge several keystrokes into a single command, rather than store each keypress as a separate step as had been the case with the HP-65. The HP-67 and HP-97 also added a “smart” card reader that could store calculator status information on the cards as well as either programs or data.

Some of the interesting new features on these models included:

- A flag that would be set upon entering a number from the keyboard, allowing the detection of input by the user;
- A set of 10 data registers that were exchangeable with another set of 10 data registers, referred to as primary/secondary registers; and
- The ability to write programs that would print on the HP-97 but pause to display results on the HP-67, allowing programs written on one model to be executed on the other without modification.

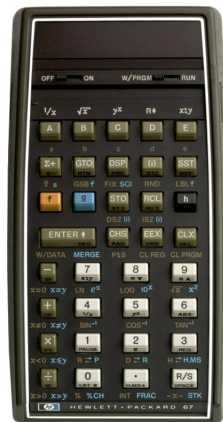

HP-67

iv Introduction

Users took advantage of this increased power by programming even more interesting applications and games. One game program of special interest, named Pinball Wizard, was very popular (and yes, the author used two z's in the program name). HP accepted programs for the HP-67 and HP-97 into the HP-67/97 Users' Library, which ended up containing over 4800 submitted programs.

Due to their more capable programming features and lower price point compared to the earlier HP-65, these two new models were also widely adopted by professionals and companies for specialized uses. The HP-67 was sold for over 5 years while the HP-97 was sold for over 8 years. These models certainly filled a need.

Meanwhile, HP had been developing another line of smaller programmable calculators that did not include the ability to save programs externally. The first of these, still remembered fondly by all who owned one, was the HP-25, introduced on August 1, 1975. While this model only had 49 fully-merged program steps, its small size and well-rounded feature set created many fans. The PPC Journal published a user-created collection of 56 programs for this model, addressing topics from probability distributions such as normal, binomial, hypergeometric, to math functions such as the Bessel, Error, Gamma, and more. Users also wrote a wide range of game programs to run in this little marvel, such as bagels, subhunt, roulette, blackjack, slot machine, and more.



HP-25C

Following the HP-25 came the HP-25C, the first handheld calculator model with a letter at the end of the name. Earlier HP products were normally referred to by a number followed by a letter. With HP's calculators, the naming was different, and models had two digits. After the introduction of the HP-25C, nearly all models were named with one or two digits followed by one or two letters.

As a historical note, the letter A was the standard letter at the end of a calculator model number, although it was not explicitly used in calculator advertisements or manuals. So for instance, the original HP-35 was officially the HP-35A, but was not normally referred to as such. The letter B eventually referred to business models, C referred to a continuous memory model. The letter E was used for the series E models discussed below (E for "Easy"—easy to assemble as the original versions clicked together with a minimum of

solder used in their assembly). The letter S was used for scientific models, such as the later HP 35s model. Some updated models have the symbol + or the Roman numeral II added at their end. A few even have both, such as the HP 10bII+. This makes for a wide range of naming conventions!

The newly introduced HP-25C added continuous memory to the already successful original HP-25 model. While the HP-65 and HP-67 could store programs and data on magnetic cards, the HP-25 did not have a card reader/writer. When turned off, the calculator lost any data or programs that had been loaded. The HP-25C used an entirely new chip design process from HP that allowed it to save programs and data even when turned off. It is difficult to overstate users' amazement at first seeing a device remember things when turned off—something that is taken for granted today.

On July 1, 1977, HP introduced the successor to the HP-25C, named the HP-29C, along with a printing version of this model two months later, the HP-19C. The HP-29C model was the same size and shape as the HP-25C, but doubled the available program memory and added incremental programming and math functions. While a great machine in its own right, this model had a relatively short time in the limelight due to the advancement of technology and capability being built into each new calculating device.

On April 17, 1978, HP announced the Series E machines, designed as a family of less expensive models. They ranged from an inexpensive scientific model (the HP-31E) to a 49-step programmable (the HP-33E) to two financial calculator models (the HP-37E and HP-38E—the latter of which was programmable too) following in the footsteps of earlier finance machines.

On July 16, 1979, HP introduced a new computing standard, a top-of-the-line model serving as the heart of a computing system, the HP-41C, the first HP handheld calculator with a Liquid Crystal Display (LCD) and the ability to display letters as well as numbers. This model led down the path of additional advanced RPN models such as the HP-42S but also the transition to RPL (standing for Reverse Polish Lisp or ROM-based Procedural Language) models such as the HP 48SX, HP 48GX, HP 49G, HP 49g+, and the HP 50g. HP then introduced the HP Prime in 2014, their most capable, powerful calculator ever made. That, however, is a story for another time.



HP-41C

vi Introduction

On August 15, 1979, HP announced updates to the HP-33E and HP-38E models to include continuous memory (named the HP-33C and HP-38C). HP also announced the HP-34C, an entirely new model in the Series E calculator family. This model, like those that had gone before, was programmable, but did not have external storage. Instead, it too relied upon continuous memory to retain programs and data. The HP-34C was able to adjust memory between program and data storage. The default was to have 70 bytes of program memory space and 21 data registers. These data registers would be converted to program memory automatically as a user entered a longer program, up to the point of having 210 program bytes available with one permanent data register remaining.

The HP-34C incorporated new, built-in features that were never before available on a handheld calculating device. The HP-34C included a generalized solve feature. Users would enter a program evaluating a function and when **SOLVE** was executed, it would attempt to find a value where the function was equal to zero—a root of the function.



HP-34C

For example, the user can write a short program to evaluate $x^2 - 4$ and then input a range between 1 and 5 as an estimate for the root, and then execute **SOLVE**. A result of 2 is returned for the root, a value of x where the function is equal to zero. No previous calculator had ever had a built-in function that would do this so easily, although programs had previously been written to do it.

The other groundbreaking feature on the HP-34C was the ability to numerically integrate a function entered as a program, between an upper and a lower limit. There had been long user programs written in the past that would apply various approaches to evaluating an integral numerically, but the HP-34C was designed to evaluate the numeric integral of any user-entered program if at all possible.

Thus if a short program were entered that computed $1/x$, the user could enter a lower and upper limit of integration, say 1 and 6, and then execute the **∫** function on the keyboard. The HP-34C would perform the integration if possible, in this case displaying 1.7918 to four decimal places, the natural log of 6, the correct answer.

Whole classes of problems could now be solved on a handheld calculator with an ease of use that had never been seen before. The problem was that this calculator, and all the other models previously introduced other than the HP-

41C, were usually tied to a short period of use before needing to be plugged into an outlet and recharged due to those lovely, but power-hungry red LED displays. If only there were a way to **SOLVE** that problem!

HP solved that problem on the remaining models with the introduction on September 1, 1981, of their new slimline series of calculators, codenamed Voyager, beginning with the HP-11C and HP-12C. While the HP-11C was discontinued in early 1989, the HP-12C became such a standard in the financial sector that it has been continuously sold for over 41 years as of this writing.

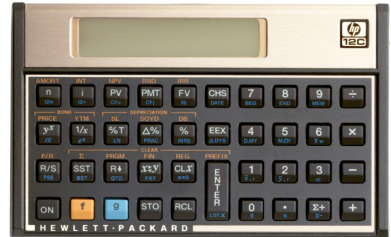

HP-12C

Ten months after the HP-11C and HP-12C, HP introduced the HP-15C and the HP-16C on July 1, 1982—two new models with the same shape and size.

The HP-16C was aimed at systems programmers and appropriately named the “Computer Scientist” by HP. The brochure for this model began: “The most powerful calculator ever designed for computer science and digital electronics applications” and that it was. The HP-16C had four number bases (binary, octal, decimal, and hexadecimal), four Boolean operators (AND, OR, XOR [Exclusive OR], and NOT), extensive bit manipulation abilities, and variable word size (up to 64 bits), plus one’s and two’s complements.

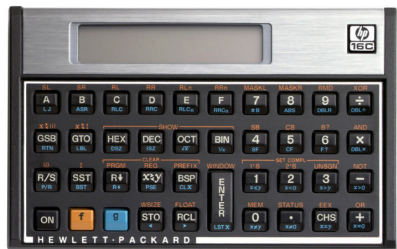

HP-16C

An example in the HP-16C Owner’s Handbook included a program to convert between IEEE standard floating-point binary format and the floating-point decimal format used in the HP-16C itself. Programming abilities included a maximum of 203 program lines or 101 16-bit data registers, in addition to 16 program labels, 4 levels of subroutines, 6 flags, and 8 conditional tests. It is still in high demand in its niche on the used market...if you can find one!

viii Introduction

The HP-15C

Meanwhile the HP-15C took the groundbreaking features of the HP-34C, including the root solver and numerical integration, expanded them, and placed them into a slimline LCD package with incredible battery life. It could be taken anywhere and seemed to run forever on one set of batteries. It expanded upon the features of the HP-34C by:

- Increasing program and data storage space;
- Providing annunciators in the display indicating calculator status;
- Featuring a **USER** mode, where the first five keys at the top left can begin the program execution of the label written above the key rather than perform the function on the key;
- Computing hyperbolic trigonometry functions and their inverses;
- Adding combinations, permutations, and a random number generator;
- Extending the function set to work with complex numbers where possible;
- Introducing a broad array of matrix functionality;
- Fitting it all in a four-ounce device.

The HP-15C had roughly twice the memory of the earlier HP-34C, with 67 total registers available for use as program or data. On the HP-15C, three registers were permanently allocated for data storage, but the remaining 64 registers could be set aside for data usage in any combination from 0 to 64, with registers being used for program storage at the rate of 7 bytes per register.



HP-15C

When placed in complex number mode, the HP-15C's four level RPN stack extended to handle the real and imaginary portions of a complex number entered for computation—essentially creating a parallel stack for the imaginary part of each complex number. Adding two complex numbers together was therefore just as easy as adding two real numbers. In fact, about the only mathematical operations that did not work with complex numbers were the polar to rectangular conversion and its inverse. Complex numbers were no longer complex at all.

Matrix functionality was built in to handle up to an 8×8 matrix. Functions provided included finding determinants, inverses, LU decomposition, scalar and matrix arithmetic, transpose, solving systems of equations, norms, residuals, and transformations. These abilities were not lost on students and professionals alike. The HP-15C remained highly popular!

Nevertheless, as technology moved on, HP replaced the HP-15C with a range of later models. These had more features and greater speed than the HP-15C, yet users yearned for the HP-15C's particular characteristics, including the horizontal layout. Prices for secondhand units rose steadily, and former users pressed HP to bring the HP-15C back. After all, if HP continued to make the HP-12C, could they not use the same basic model to build a revived HP-15C? In 2011 HP did produce a limited number of HP-15C units, described as the HP 15c Limited Edition.

The HP 15c Collector's Edition

Now, a further 12 years later, you have in your hands a second revival: the HP 15c Collector's Edition. Yet it is not just for collectors—it is a powerful calculator in its own right, faster and with more memory than the original HP-15C. The HP 15c CE now provides:

- 672 bytes of program memory (one or two bytes per instruction), increased from 448, while retaining the HP-15C's sophisticated programming capability, including conditional and unconditional branching, subroutines, flags, and editing.
- Direct and indirect storage in up to 99 registers, increased from 67.

In general the extra memory and speed are an advantage, but there will be some cases where care is needed:

- If a program written for the original HP-15C relies on special timing, for example if a program gives the user a fixed time to react, then that program will need to be slowed down on the HP 15c CE, possibly by the addition of **PSE** (pause) steps or by making loops repeat more times. This is described in more detail in Appendix G.
- The original self-tests for the HP-15C will not work with the new platform of the HP 15c CE and have been replaced with new tests described in Appendix F.

This Handbook

HP calculators of the 1970s and the 1980s were not just technological feats. They were supported by manuals that were feats of technical writing. The manuals introduced the features of the calculator and supported the reader with varied examples of use. Some of these examples were whimsical and added to the joy of reading the manuals. One particular example remembered by HP enthusiasts was in the HP-25 manual, and concerned lovesick sailor Oscar Odysseus, who found himself on the remote island of Tristan da Cunha. The example showed owners how to use the HP-25 to calculate the great circle distance to his sweetheart Penelope on St Helena.

This handbook is written for you, regardless of your level of expertise. The first part, Fundamentals, covers all the basic functions of the HP 15c and how to use them. Each section in the second part, Programming, is broken down into three subsections—The Mechanics, Examples, and Further Information—in order to make it easy for users with varying backgrounds to find the information they need. The third part, Advanced Functions, describes the four advanced mathematics capabilities.*

Before starting these sections, you may want to gain some operating and programming experience on the HP 15c by working through the introductory material, The HP 15c: A Problem Solver, on page 12.

The various appendices describe additional details of calculator operation. The Function Summary and Index and the Programming Summary and Index at the back of this manual can be used for quick reference to each function key and as a handy page reference to more comprehensive information.

We hope that you will enjoy working through this manual for the HP 15c CE, and through its companion, the *HP 15c Advanced Functions Handbook*, which provides further details, particularly of the **SOLVE** and  (Integrate) functions, but also of complex number and matrix calculations. In that handbook, you will find examples involving people such as radio engineer Ann Tenor—as well as programs equivalent to the Time Value of Money and Discounted Cash Flow Analysis applications built into HP's financial calculators. These are long programs, but with the increased memory size of the HP 15c CE you can keep them in your calculator and use it as a substitute for an HP-12C business calculator as well as for scientific and technical calculations.

* You certainly do not need to read every part of the manual before delving into Part III: HP 15c Advanced Functions if you are already familiar with HP calculators. The use of **SOLVE** and  requires a knowledge of HP 15c programming.

The HP Community

One of the benefits of owning an HP calculator is that there are large numbers of people like you who own one as well. In fact, there are still active groups and websites where users gather in person and virtually. These sites and groups can be sources of great information and can often provide answers to questions. Some of the most helpful sites include:

- hpcc.org – This is the website for a group of users that has been in existence since 1982, centered in London, England, and which still publishes a journal of articles, application programs, and other material. Back issues are available as well. The group also holds regular meetings online and in person.
- hhuc.us – This site contains information about the HP handheld users' conferences in the US since 1999. These meetings continue to be held and information about future conferences can be found there.
- hpmuseum.org – In addition to being an online museum for HP calculators where you can look up a favorite model from the past, this site has a very active discussion forum about current and older HP calculator models, things related to HP calculators, or things completely unrelated to HP calculators. There is also a section of the forum devoted to software for various HP calculators containing user-submitted programs.
- commerce.hpcalc.org – This site offers a USB thumb drive with more than ten years' worth of PPC Journal issues mentioned earlier along with an incredible amount of other calculator documentation and materials. It also contains copies of the presentations made at previous HP handheld users' conference gatherings. Check there for more information.
- literature.hpcalc.org – This site has scans of a large number of HP calculator manuals and training materials as well as of non-HP materials, including books, in several different languages. Be sure to check it out.

Note: None of the above sites are in any way associated with HP.

If you have a question or wish to see if someone has already found a solution to a problem you are facing, check these resources out.

So enjoy this updated version of a true classic. There are always new problems to be solved and the HP 15c CE is ready and able to help!

February, 2023

Włodek Mier-Jędrzejowicz
Chairman, hpcc.org

Gene Wright
Moderator, hpmuseum.org/forum

Contents

| | |
|--|----|
| The HP 15c: A Problem Solver | 12 |
| A Quick Look at ENTER | 12 |
| Manual Solutions | 13 |
| Programmed Solutions | 14 |
| Part I: HP 15c Fundamentals | 17 |
| Section 1: Getting Started | 18 |
| Power On and Off | 18 |
| Keyboard Operation | 18 |
| Primary and Alternate Functions | 18 |
| Prefix Keys | 19 |
| Changing Signs | 19 |
| Keying in Exponents | 19 |
| The “CLEAR” Keys | 20 |
| Display Clearing: CLX and ← | 21 |
| Calculations | 22 |
| One-Number Functions | 22 |
| Two-Number Functions and ENTER | 22 |
| Section 2: Numeric Functions | 24 |
| Pi | 24 |
| Number Alteration Functions | 24 |
| One-Number Functions | 25 |
| General Functions | 25 |
| Trigonometric Operations | 26 |
| Time and Angle Conversions | 26 |
| Degrees/Radians Conversions | 27 |
| Logarithmic Functions | 28 |
| Hyperbolic Functions | 28 |
| Two-Number Functions | 29 |
| The Power Function | 29 |
| Percentages | 29 |
| Polar and Rectangular Coordinate Conversions | 30 |
| Section 3: The Automatic Memory Stack, LAST X, and Data Storage | 32 |
| The Automatic Memory Stack and Stack Manipulation | 32 |

| | |
|---|----|
| Stack Manipulation Functions | 33 |
| The LAST X Register and LSTX | 35 |
| Calculator Functions and the Stack | 36 |
| Order of Entry and the ENTER Key | 37 |
| Nested Calculations | 38 |
| Arithmetic Calculations With Constants | 39 |
| Storage Register Operations | 42 |
| Storing and Recalling Numbers | 42 |
| Clearing Data Storage Registers | 43 |
| Storage and Recall Arithmetic | 43 |
| Overflow and Underflow | 45 |
| Problems | 45 |
| Section 4: Statistics Functions | 47 |
| Probability Calculations | 47 |
| Random Number Generator | 48 |
| Accumulating Statistics | 49 |
| Correcting Accumulated Statistics | 52 |
| Mean | 53 |
| Standard Deviation | 53 |
| Linear Regression | 54 |
| Linear Estimation and Correlation Coefficient | 55 |
| Other Applications | 56 |
| Section 5: The Display and Continuous Memory | 58 |
| Display Control | 58 |
| Fixed Decimal Display | 58 |
| Scientific Notation Display | 58 |
| Engineering Notation Display | 59 |
| Mantissa Display | 60 |
| Round-Off Error | 60 |
| Special Displays | 60 |
| Annunciators | 60 |
| Digit Separators | 61 |
| Error Display | 61 |
| Overflow and Underflow | 61 |
| Low-Power Indication | 62 |
| Continuous Memory | 62 |
| Status | 62 |
| Resetting Continuous Memory | 63 |
| Adjusting Display Contrast | 63 |

- Part II: HP 15c Programming** 65
 - Section 6: Programming Basics** 66
 - The Mechanics 66
 - Creating a Program 66
 - Loading a Program 66
 - Intermediate Program Stops 68
 - Running a Program 68
 - How to Enter Data 69
 - Program Memory 70
 - Example 70
 - Further Information 74
 - Program Instructions 74
 - Instruction Coding 74
 - Memory Configuration 75
 - Program Boundaries 77
 - Unexpected Program Stops 78
 - Abbreviated Key Sequences 78
 - User Mode 79
 - Polynomial Expressions and Horner's Method 79
 - Nonprogrammable Functions 80
 - Problems 81
 - Section 7: Program Editing** 82
 - The Mechanics 82
 - Moving to a Line in Program Memory 82
 - Deleting Program Lines 83
 - Inserting Program Lines 83
 - Examples 83
 - Further Information 85
 - Single-Step Operations 85
 - Line Position 86
 - Insertions and Deletions 87
 - Initializing Calculator Status 87
 - Problems 87
 - Section 8: Program Branching and Controls** 90
 - The Mechanics 90
 - Branching 90
 - Conditional Tests 91

| | |
|--|-----|
| Flags | 92 |
| Examples | 93 |
| Example: Branching and Looping | 93 |
| Example: Flags | 95 |
| Further Information | 97 |
| Go To | 97 |
| Looping | 98 |
| Conditional Branching | 98 |
| Flags | 98 |
| The System Flags: Flags 8 and 9 | 99 |
| Section 9: Subroutines | 101 |
| The Mechanics | 101 |
| Go To Subroutine and Return | 101 |
| Subroutine Limits | 102 |
| Examples | 102 |
| Further Information | 105 |
| The Subroutine Return | 105 |
| Nested Subroutines | 105 |
| Section 10: The Index Register and Loop Control | 106 |
| The I and (i) Keys | 106 |
| Direct Versus Indirect Data Storage With the Index Register..... | 106 |
| Indirect Program Control With the Index Register | 107 |
| Program Loop Control | 107 |
| The Mechanics | 107 |
| Index Register Storage and Recall | 107 |
| Index Register Arithmetic | 108 |
| Exchanging the X-Register | 108 |
| Indirect Branching With I | 108 |
| Indirect Flag Control With I | 109 |
| Indirect Display Format Control With I | 109 |
| Loop Control with Counters: ISG and DSE | 109 |
| Examples | 111 |
| Examples: Register Operations | 111 |
| Example: Loop Control With DSE | 112 |
| Example: Display Format Control | 114 |
| Further Information | 115 |
| Index Register Contents | 115 |
| ISG and DSE | 116 |
| Indirect Display Control | 116 |

| | |
|---|-----|
| Part III: HP 15c Advanced Functions | 119 |
| Section 11: Calculating With Complex Numbers | 120 |
| The Complex Stack and Complex Mode | 120 |
| Creating the Complex Stack | 120 |
| Deactivating Complex Mode | 121 |
| Complex Numbers and the Stack | 121 |
| Entering Complex Numbers | 121 |
| Stack Lift in Complex Mode | 124 |
| Manipulating the Real and Imaginary Stacks | 124 |
| Changing Signs | 124 |
| Clearing a Complex Number | 125 |
| Entering a Real Number | 128 |
| Entering a Pure Imaginary Number | 129 |
| Storing and Recalling Complex Numbers | 130 |
| Operations With Complex Numbers | 130 |
| One-Number Functions | 131 |
| Two-Number Functions | 131 |
| Stack Manipulation Functions | 131 |
| Conditional Tests | 132 |
| Complex Results from Real Numbers | 133 |
| Polar and Rectangular Coordinate Conversions | 133 |
| Problems | 135 |
| For Further Information | 137 |
| Section 12: Calculating With Matrices | 138 |
| Matrix Dimensions | 140 |
| Dimensioning a Matrix | 141 |
| Displaying Matrix Dimensions | 142 |
| Changing Matrix Dimensions | 142 |
| Storing and Recalling Matrix Elements | 143 |
| Storing and Recalling All Elements in Order | 143 |
| Checking and Changing Matrix Elements Individually | 145 |
| Storing a Number in All Elements of a Matrix | 147 |
| Matrix Operations | 147 |
| Matrix Descriptors | 147 |
| The Result Matrix | 148 |
| Copying a Matrix | 149 |
| One-Matrix Operations | 149 |

| | |
|---|-----|
| Scalar Operations | 151 |
| Arithmetic Operations | 153 |
| Matrix Multiplication | 154 |
| Solving the Equation $\mathbf{AX} = \mathbf{B}$ | 156 |
| Calculating the Residual | 159 |
| Using Matrices in LU Form | 160 |
| Calculations With Complex Matrices | 160 |
| Storing the Elements of a Complex Matrix | 161 |
| The Complex Transformations Between Z^P and \check{Z} | 164 |
| Inverting a Complex Matrix | 165 |
| Multiplying Complex Matrices | 166 |
| Solving the Complex Equation $\mathbf{AX} = \mathbf{B}$ | 168 |
| Miscellaneous Operations Involving Matrices | 173 |
| Using a Matrix Element With Register Operations | 173 |
| Using Matrix Descriptors in the Index Register | 173 |
| Conditional Tests on Matrix Descriptors | 174 |
| Stack Operation for Matrix Calculations | 174 |
| Using Matrix Operations in a Program | 176 |
| Summary of Matrix Functions | 177 |
| For Further Information | 179 |
| Section 13: Finding the Roots of an Equation | 180 |
| Using SOLVE | 180 |
| When No Root Is Found | 186 |
| Choosing Initial Estimates | 188 |
| Using SOLVE in a Program | 192 |
| Restriction on the Use of SOLVE | 193 |
| Memory Requirements | 193 |
| For Further Information | 193 |
| Section 14: Numerical Integration | 194 |
| Using \int_y^x | 194 |
| Accuracy of \int_y^x | 200 |
| Using \int_y^x in a Program | 203 |
| Memory Requirements | 204 |
| For Further Information | 204 |
| Appendix A: Error Conditions | 205 |

10 Contents

| | |
|--|-----|
| Appendix B: Stack Lift and the LAST X Register | 209 |
| Digit Entry Termination | 209 |
| Stack Lift | 209 |
| Disabling Operations | 210 |
| Enabling Operations | 210 |
| Neutral Operations | 211 |
| LAST X Register | 212 |
| Appendix C: Memory Allocation | 213 |
| The Memory Space | 213 |
| Registers | 213 |
| Memory Status (MEM) | 215 |
| Memory Reallocation | 215 |
| The DIM (i) Function | 215 |
| Restrictions on Reallocation | 216 |
| Program Memory | 217 |
| Automatic Program Memory Reallocation | 217 |
| Two-Byte Program Instructions | 218 |
| Memory Requirements for the Advanced Functions | 218 |
| Appendix D: A Detailed Look at SOLVE | 220 |
| How SOLVE Works | 220 |
| Accuracy of the Root | 222 |
| Interpreting Results | 226 |
| Finding Several Roots | 233 |
| Limiting the Estimation Time | 238 |
| Counting Iterations | 238 |
| Specifying a Tolerance | 238 |
| For Advanced Information | 239 |
| Appendix E: A Detailed Look at \int | 240 |
| How \int Works | 240 |
| Accuracy, Uncertainty, and Calculation Time | 241 |
| Uncertainty and the Display Format | 245 |
| Conditions That Could Cause Incorrect Results | 249 |
| Conditions That Prolong Calculation Time | 254 |
| Obtaining the Current Approximation to an Integral | 257 |
| For Advanced Information | 258 |
| Appendix F: Batteries, Self-Tests, and Regulatory Information | 259 |
| Batteries | 259 |

| | |
|---|--------------------------|
| Low-Power Indication | 259 |
| Installing New Batteries | 260 |
| Verifying Proper Operation (Self-Tests) | 261 |
| Legal Notice | 262 |
| Customer Care | 263 |
| Regulatory Information and Environmental Limits | 263 |
| Limited Hardware Warranty | 263 |
| Region-Specific Notices | 264 |
| Appendix G: Differences Between the HP 15c CE and HP-15C | 269 |
| Performance | 269 |
| Memory | 269 |
| Battery Usage | 270 |
| Self-Tests | 270 |
| Display | 270 |
| Appendix H: Known Limitations | 271 |
| Function Summary and Index | 272 |
| Complex Functions | 272 |
| Conversions | 273 |
| Digit Entry | 273 |
| Display Control | 273 |
| Hyperbolic Functions | 273 |
| Index Register Control | 274 |
| Logarithmic and Exponential Functions | 274 |
| Mathematics | 274 |
| Matrix Functions | 274 |
| Number Alteration | 276 |
| Percentage | 276 |
| Prefix Keys | 276 |
| Probability | 276 |
| Stack Manipulation | 277 |
| Statistics | 277 |
| Storage | 278 |
| Trigonometry | 278 |
| Programming Summary and Index | 278 |
| Subject Index | 281 |
| The HP 15c Keyboard and Continuous Memory | Inside Back Cover |

The HP 15c: A Problem Solver

The HP 15c Advanced Programmable Scientific Calculator is a powerful problem solver, convenient to carry and easy to hold. Its Continuous Memory retains data and program instructions indefinitely until you choose to reset it. Though sophisticated, it requires no prior programming experience or knowledge of programming languages to use it.

The HP 15c conserves power by automatically shutting its display off if it is left inactive for a few minutes. But don't worry about losing data—any information contained in the HP 15c is saved by Continuous Memory.

A Quick Look at **ENTER**

Your HP calculator uses a unique operating logic, represented by the **ENTER** key, that differs from the logic in most other calculators. You will find that using **ENTER** makes nested and complicated calculations easier and faster to work out. Let's get acquainted with how this works.

For example, let's look at the arithmetic functions. First we have to get the numbers into the machine. Is your calculator on? If not, press **ON**. Is the display cleared? To display all zeros, you can press **g** **CLX**, that is, press **g**, then **←**.^{*} To perform arithmetic, key in the first number, press **ENTER** to separate the first number from the second, then key in the second number and press **+**, **-**, **×**, or **÷**. The result appears immediately after you press any numerical function key.

^{*} If you have not used an HP calculator before, you will notice that most keys have three labels. To use the primary function—the one printed in white on top of the key—just press that key. For those printed in gold or blue, press the gold **f** key or the blue **g** key first.

The display format used in this handbook is $\boxed{\text{FIX}} 4$ (the decimal point is “fixed” to show four decimal places) unless otherwise mentioned. If your calculator does not show four decimal places, you may want to press $\boxed{\text{f}}$ $\boxed{\text{FIX}} 4$ to match the displays in the examples.

Manual Solutions

Run through the following two-number calculations. It is not necessary to clear the calculator between problems. If you enter a digit incorrectly, press $\boxed{\leftarrow}$ to undo the mistake, then key in the correct number.

| To Compute: | Keystrokes | Display |
|-------------------|---|--------------|
| $9 - 6 = 3$ | 9 $\boxed{\text{ENTER}}$ 6 $\boxed{-}$ | 3.0000 |
| $9 \times 6 = 54$ | 9 $\boxed{\text{ENTER}}$ 6 $\boxed{\times}$ | 54.0000 |
| $9 \div 6 = 1.5$ | 9 $\boxed{\text{ENTER}}$ 6 $\boxed{\div}$ | 1.5000 |
| $9^6 = 531,441$ | 9 $\boxed{\text{ENTER}}$ 6 $\boxed{y^x}$ | 531,441.0000 |

Notice that in the four examples:

- Both numbers are in the calculator before you press the function key.
- $\boxed{\text{ENTER}}$ is used only to separate two numbers that are keyed in one after the other.
- Pressing a numeric function key, in this case $\boxed{-}$, $\boxed{\times}$, $\boxed{\div}$, or $\boxed{y^x}$, executes the function immediately and displays the result.

To see the close relationship between manual and programmed problem solving, let's first calculate the solution to a problem manually, that is, from the keyboard. Then we'll use a program to calculate the solution to the same problem with different data.

14 The HP 15c: A Problem Solver

The time an object takes to fall to the ground (ignoring air friction) is given by the formula

$$t = \sqrt{\frac{2h}{g}},$$

where t = time in seconds,
 h = height in meters,
 g = the acceleration due to gravity, 9.8 m/s^2 .

Example: Compute the time taken by a stone falling from the top of the Eiffel Tower (300.51 meters high) to the earth.

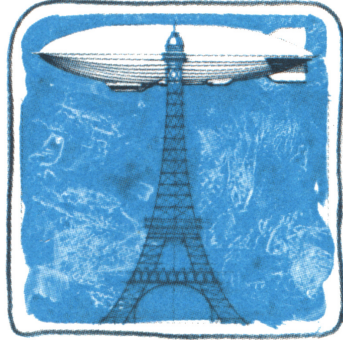

Keystrokes

300.51

2

9.8

Display

300.5100

601.0200

61.3286

7.8313

Enter h .

Calculates $2h$.

$(2h)/g$.

Falling time, seconds.

Programmed Solutions

Suppose you wanted to calculate falling times from various heights. The easiest way is to write a program to cover all the constant parts of a calculation and provide for entry of variable data.

Writing the Program. The program is similar to the keystroke sequence you used above. A label is useful to define the beginning of a program, and a return is useful to mark the end of a program. Also, the program must accommodate the entry of new data.

Loading the Program. You can load a program for the above problem by pressing the following keys in sequence. (The display shows information which you can ignore for now, though it will be useful later.)

| Keystrokes | Display | |
|---|----------------|---|
| g P/R | 000- | Sets HP 15c to Program mode. (PRGM annunciator on.) |
| f CLEAR PRGM | 000- | Clears program memory. (This step is optional here.) |
| f LBL A | 001-42, 21, 11 | Label "A" defines the beginning of the program. |
| 2 | 002- | <div style="display: flex; align-items: center;"> <div style="margin-right: 10px;"> <div style="border-left: 1px solid black; border-right: 1px solid black; border-top: 1px solid black; border-bottom: 1px solid black; padding: 0 5px;">2</div> <div style="border-left: 1px solid black; border-right: 1px solid black; border-top: 1px solid black; border-bottom: 1px solid black; padding: 0 5px;">20</div> <div style="border-left: 1px solid black; border-right: 1px solid black; border-top: 1px solid black; border-bottom: 1px solid black; padding: 0 5px;">9</div> <div style="border-left: 1px solid black; border-right: 1px solid black; border-top: 1px solid black; border-bottom: 1px solid black; padding: 0 5px;">48</div> <div style="border-left: 1px solid black; border-right: 1px solid black; border-top: 1px solid black; border-bottom: 1px solid black; padding: 0 5px;">8</div> <div style="border-left: 1px solid black; border-right: 1px solid black; border-top: 1px solid black; border-bottom: 1px solid black; padding: 0 5px;">10</div> <div style="border-left: 1px solid black; border-right: 1px solid black; border-top: 1px solid black; border-bottom: 1px solid black; padding: 0 5px;">11</div> </div> <div style="font-size: 2em; vertical-align: middle;">}</div> <div style="margin-left: 10px;"> <p>The same keys you pressed to solve the problem manually.</p> </div> </div> |
| x | 003- | |
| 9 | 004- | |
| . | 005- | |
| 8 | 006- | |
| ÷ | 007- | |
| √x | 008- | |
| g RTN | 009- 43 32 | "Return" defines the end of the program. |
| g P/R | 7.8313 | Switches to Run mode. (No PRGM annunciator.) |

Running the Program. Enter the following information to run the program.

| Keystrokes | Display | |
|--|---------|--|
| 300.51 | 300.51 | Height of the Eiffel Tower. |
| f A | 7.8313 | Falling time you calculated earlier. |
| 1050 f A | 14.6385 | The time (seconds) for a stone to reach the ground after release from a blimp 1050 m high. |

16 The HP 15c: A Problem Solver

With this program loaded, you can quickly calculate the time of descent of an object from different heights. Simply key in the height and press \boxed{f} \boxed{A} . Find the time of descent for objects released from heights of 100 m, 2 m, 275 m, and 2,000 m.

The answers are: 4.5175 s; 0.6389 s; 7.4915 s; and 20.2031 s.

That program was relatively easy. You will see many more aspects and details of programming in Part II. For now, turn the page to Part I to take an in-depth look at some of the calculator's important operating basics.

Part I

HP 15c

Fundamentals

Section 1

Getting Started

Power On and Off

The **ON** key turns the HP 15c on and off.* To conserve power, the calculator automatically turns itself off after a few minutes of inactivity.

Keyboard Operation

Primary and Alternate Functions

Most keys on your HP 15c perform one primary and two alternate, shifted functions. The primary function of any key is indicated by the character(s) on the face of the key. The alternate functions are indicated by the gold characters printed above the key and the blue characters printed on the lower face of the key.

- To select the primary function printed on the face of a key, press only that key. For example: **÷**.
- To select the alternate function printed in gold or blue, press the like-colored prefix key (**f** or **g**) followed by the function key. For example: **f** **SOLVE**; **g** **$x \leq y$** .

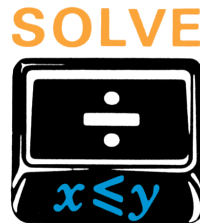

Throughout this handbook, we will observe certain conventions in referring to alternate functions. References to the *function itself* will appear as just the key name in a box, such as “the **MEM** function”. References to *the use of the key* will include the prefix key, such as “press **g** **MEM**”. References to the four gold functions printed under the bracket labeled “**CLEAR**” will be preceded by the word “**CLEAR**”, such as “the **CLEAR** **REG** function”, or “press **f** **CLEAR** **PRGM**”.

* Note that the **ON** key is lower than the other keys to help prevent its being pressed inadvertently.

Notice that when you press the **f** or **g** prefix key, an **f** or **g** annunciator appears and remains in the display until a function key is pressed to complete the sequence.



Prefix Keys

A prefix key is any key which must precede another key to complete the key sequence for a function. Certain functions require two parts: a prefix key and a digit or other key. For your reference, the prefix keys are:



If you make a mistake while keying in a prefix for a function, press **f** CLEAR **PREFIX** to cancel the error. The CLEAR **PREFIX** key is also used to show the mantissa of a displayed number, so all 10 digits of the number in the display will appear for a moment after the **PREFIX** key is pressed.

Changing Signs

Pressing **CHS** (*change sign*) will change the sign (positive or negative) of any displayed number. To key in a negative number, press **CHS** after its digits have been keyed in.

Keying in Exponents

EEX (*enter exponent*) is used when keying in a number with an exponent. First key in the mantissa, then press **EEX** and key in the exponent.

For a negative exponent press **CHS** after keying in the exponent.* For example, to key in Planck's constant (6.6262×10^{-34} Joule-seconds) and multiply it by 50:

* **CHS** may also be pressed after **EEX** and *before* the exponent, with the same result (unlike the mantissa, where digit entry must precede **CHS**).

20 Section 1: Getting Started

| Keystrokes | Display | | |
|--------------|----------|-----|--|
| 6.6262 | 6 . 6262 | | |
| EEX | 6 . 6262 | 00 | The 00 prompts you to key in the exponent. |
| 3 | 6 . 6262 | 03 | (6.6262×10^3) . |
| 4 | 6 . 6262 | 34 | (6.6262×10^{34}) . |
| CHS | 6 . 6262 | -34 | (6.6262×10^{-34}) . |
| ENTER | 6 . 6262 | -34 | Enters number. |
| 50 X | 3 . 3131 | -32 | Joule-seconds. |

Note: Decimal digits from the mantissa that spill into the exponent field will disappear from the display when you press **EEX**, but will be retained internally.

To prevent a misleading display pattern, **EEX** will not operate with a number having more than seven digits to the left of the radix mark (decimal point), nor with a mantissa smaller than 0.000001. To key in such a number, use a form having a greater exponent value (whether positive or negative). For example, $123456789.8 \times 10^{23}$ can be keyed in as $1234567.898 \times 10^{25}$; $0.00000025 \times 10^{-15}$ can be keyed in as 2.5×10^{-22} .

The “CLEAR” Keys

Clearing means to replace a number with zero. The clearing operations in the HP 15c are (the table is continued on the next page):

| Clearing Sequence | Effect |
|--|--|
| g CLX | Clears display (X-register). |
| ← In Run mode: In Program mode: | Clears last digit or entire display. Deletes current instruction. |
| f CLEAR Σ | Clears statistics storage registers, display, and the memory stack (described in Section 3). |

| Clearing Sequence | Effect |
|--|--|
| f CLEAR [PRGM] In Run mode: In Program mode: f CLEAR [REG] f CLEAR [PREFIX]* | Repositions program memory to line 000. Deletes all program memory. Clears all data storage registers. Clears any prefix from a partially entered key sequence. |
| * Also temporarily displays the mantissa. | |

Display Clearing: [CLX] and [←]

The HP 15c has two types of display clearing operations: [CLX] (*clear X*) and [←] (*back arrow*).

In Run mode:

- [CLX] clears the display to zero.
- [←] deletes only the last digit in the display *if digit entry has not been terminated* by [ENTER] or most other functions. You can then key in a new digit or digits to replace the one(s) deleted. If digit entry *has been terminated*, then [←] acts like [CLX].

| Keystrokes | Display | |
|------------|------------|-----------------------------|
| 12345 | 12 , 345 | Digit entry not terminated. |
| [←] | 1 , 234 | Clears only the last digit. |
| 9 | 12 , 349 | |
| [√x] | 111 . 1261 | Terminates digit entry. |
| [←] | 0 . 0000 | Clears all digits to zero. |

In Program mode:

- [CLX] is programmable: it is *stored* as a programmed instruction, and will not delete the currently displayed instruction.
- [←] is *not* programmable, so it can be used for program correction. Pressing [←] will delete the entire instruction currently displayed.





Calculations



One-Number Functions

A one-number function performs an operation using only the number in the display. To use any one-number function, press the function key *after* the number has been placed in the display.

| Keystrokes | Display |
|---|----------|
| 45 | 45 |
|  LOG | 1 . 6532 |

Two-Number Functions and





A two-number function must have two numbers present in the calculator *before* executing the function. , , , and  are examples of two-number functions.

Terminating Digit Entry. When *keying in* two numbers to perform an operation, the calculator needs a signal that *digit entry is terminated* for the first number. This is done by pressing  to separate the two numbers. If, on the other hand, one of the numbers is already in the calculator as the result of a previous operation, you do not need to use the  key. All functions except the digit entry keys themselves* have the effect of *terminating digit entry*.

Notice that, regardless of the number, a decimal point always appears and a set number of decimal places are displayed when you terminate digit entry (as by pressing .

Chain Calculations. In the following calculations, notice that:

- The  key is used only for separating the *sequential* entry of two numbers.
- The operator is keyed in *only after* both operands are in the calculator.
- The result of any operation may itself become an operand. Such intermediate results are stored and retrieved on a last-in, first-out basis. New digits keyed in following an operation are treated as a new number.

* The digit keys, , , , and .

Example: Calculate $(9 + 17 - 4) \div 4$.

| Keystrokes | Display | |
|--------------------------------------|---------|-------------------------|
| 9 <input type="text" value="ENTER"/> | 9.0000 | Digit entry terminated. |
| 17 <input type="text" value="+"/> | 26.0000 | $(9 + 17)$. |
| 4 <input type="text" value="-"/> | 22.0000 | $(9 + 17 - 4)$. |
| 4 <input type="text" value="÷"/> | 5.5000 | $(9 + 17 - 4) \div 4$. |

Even more complicated problems are solved in the same manner—using automatic storage and retrieval of intermediate results. It is easiest to work from the inside of parentheses outwards, just as you would with calculations on paper.

Example: Calculate $(6 + 7) \times (9 - 3)$.

| Keystrokes | Display | |
|--------------------------------------|---------|--|
| 6 <input type="text" value="ENTER"/> | 6.0000 | First solve for the intermediate result of $(6 + 7)$. |
| 7 <input type="text" value="+"/> | 13.0000 | |
| 9 <input type="text" value="ENTER"/> | 9.0000 | Then solve for the intermediate result of $(9 - 3)$. |
| 3 <input type="text" value="-"/> | 6.0000 | |
| <input type="text" value="×"/> | 78.0000 | Then multiply the intermediate results together (13 and 6) for the final answer. |

Try your hand at the following problems. Each time you press or a function key in a calculation, the preceding number is saved for the next operation.

$$(16 \times 38) - (13 \times 11) = 465.0000$$

$$4 \times (17 - 12) \div (10 - 5) = 4.0000$$

$$23^2 - (13 \times 9) + 1/7 = 412.1429$$

$$\sqrt{[(5.4 \times 0.8) \div (12.5 - 0.7^2)]} = 0.5998$$

Section 2

Numeric Functions

This section discusses the numeric functions of the HP 15c (excluding statistics and advanced functions). The nonnumeric functions are discussed separately (digit entry in Section 1, stack manipulation in Section 3, and display control in Section 5).

The numeric functions of the HP 15c are used in the same way whether executed from the keyboard or in a program. Some of the functions (such as **ABS**) are, in fact, primarily of interest for programming.

Remember that the numeric functions, like all functions except digit entry functions, automatically terminate digit entry. This means a numeric function does not need to be preceded or followed by **ENTER**.

Pi

Pressing **g** **π** places the first 10 digits of π into the calculator. **π** does not need to be separated from other numbers by **ENTER**.

Number Alteration Functions

The number alteration functions act upon the number in the display (X-register).

Integer Portion. Pressing **g** **INT** replaces the number in the display with the nearest integer of lesser or equal magnitude.

Fractional Portion. Pressing **f** **FRAC** replaces the number in the display with its fractional part (that is, the difference between the number and its integer part).

Rounding. Pressing **g** **RND** rounds all 10 internally held digits of the mantissa of the displayed value to the number of digits specified by the current **FIX**, **SCI**, or **ENG** display format.

Absolute Value. Pressing **g** **ABS** yields the absolute value of the number in the display.

Keystrokes

123.4567 **[g]** **[INT]**
[g] **[LSTx]** **[CHS]** **[g]** **[INT]**

[g] **[LSTx]** **[f]** **[FRAC]**
 1.23456789 **[CHS]**

[g] **[RND]**
[f] **[CLEAR]** **[PREFIX]**

(release)

[g] **[ABS]**

Display

123.0000

-123.0000

-0.4567

-1.2346

1234600000

-1.2346

1.2346

Reversing the sign does not alter digits.

Temporarily displays all digits in the mantissa.

One-Number Functions

One-number math functions in the HP 15c operate only upon the number in the display (X-register).

General Functions

Reciprocal. Pressing **[1/x]** calculates the reciprocal of the number in the display.

Factorial and Gamma. Pressing **[f]** **[x!]** calculates the factorial of the displayed value, where x is an integer $0 \leq x \leq 69$.

You can also use **[x!]** to calculate the Gamma function, $\Gamma(x)$, used in advanced mathematics and statistics. Pressing **[f]** **[x!]** calculates $\Gamma(x + 1)$, so you must subtract 1 from your initial operand to get $\Gamma(x)$. For the Gamma function, x is not restricted to nonnegative integers.

Square Root. Pressing **[√x]** calculates the positive square root of the number in the display.

Squaring. Pressing **[g]** **[x²]** calculates the square of the number in the display.

Keystrokes

25 **[1/x]**
 8 **[f]** **[x!]**
 3.9 **[√x]**
 12.3 **[g]** **[x²]**

Display

0.0400

40,320.0000 Calculates 8! or $\Gamma(9)$.

1.9748

151.2900

Trigonometric Operations

Trigonometric Modes. The trigonometric functions operate in the trigonometric mode you select. Specifying a trigonometric mode does not convert any number already in the calculator to that mode; it merely tells the calculator what unit of measure (degrees, radians, or grads) to assign a number for a trigonometric function.

Pressing \boxed{g} \boxed{DEG} sets Degrees mode. No annunciator appears in the display. Degrees are in *decimal*, not minutes-seconds form.

Pressing \boxed{g} \boxed{RAD} sets Radians mode. The **RAD** annunciator appears in the display. In Complex mode, all functions (except $\boxed{\rightarrow P}$ and $\boxed{\rightarrow R}$) assume values are in radians, regardless of the trigonometric annunciator displayed.

Pressing \boxed{g} \boxed{GRD} sets Grads mode. The **GRAD** annunciator appears in the display.

Continuous Memory will maintain the last trigonometric mode selected. At “power up” (initial condition or when Continuous Memory is reset), the calculator is in Degrees mode.

Trigonometric Functions. Given x in the display (X-register):

| Pressing | Calculates |
|--------------------------------|-------------------|
| \boxed{SIN} | sine of x |
| \boxed{g} $\boxed{SIN^{-1}}$ | arcsine of x |
| \boxed{COS} | cosine of x |
| \boxed{g} $\boxed{COS^{-1}}$ | arccosine of x |
| \boxed{TAN} | tangent of x |
| \boxed{g} $\boxed{TAN^{-1}}$ | arctangent of x |

Before executing a trigonometric function, be sure that the calculator is set to the desired trigonometric mode (Degrees, Radians, or Grads).

Time and Angle Conversions

Numbers representing time (hours) or angles (degrees) can be converted by the HP 15c between a decimal-fraction and a minutes-seconds format:

| | | |
|----------------------------------|---|--|
| Hours.Decimal Hours (H.h) | ↔ | Hours.Minutes Seconds Decimal Seconds (H.MMSSs) |
| Degrees.Decimal Degrees (D.d) | ↔ | Degrees.Minutes Seconds Decimal Seconds (D.MMSSs) |

Hours/Degrees-Minutes-Seconds Conversion. Pressing \boxed{f} $\boxed{\rightarrow H.MS}$ converts the number in the display from a decimal hours/degrees format to an hours/degree-minutes-seconds-decimal seconds format.

For example, press \boxed{f} $\boxed{\rightarrow H.MS}$ to convert

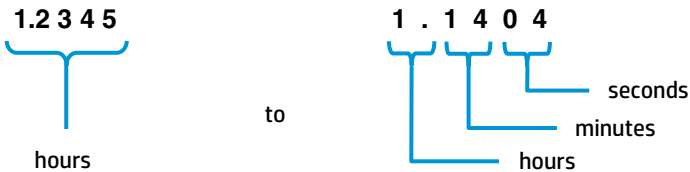

Press \boxed{f} $\boxed{\text{PREFIX}}$ to display the value to all possible decimal places:

1 1 4 0 4 2 0 0 0 0

 to the hundred-thousandths of a second.

Decimal Hours (or Degrees) Conversion. Pressing \boxed{g} $\boxed{\rightarrow H}$ converts the number in the display from an hours/degrees-minutes-seconds-decimal seconds format to a decimal hours/degrees format.

Degrees/Radians Conversions

The $\boxed{\rightarrow DEG}$ and $\boxed{\rightarrow RAD}$ functions are used to convert angles to degrees or radians (D.d \leftrightarrow R.r). The degrees must be expressed as decimal numbers, and not in a minutes-seconds format.

Keystrokes

40.5 \boxed{f} $\boxed{\rightarrow RAD}$

\boxed{g} $\boxed{\rightarrow DEG}$

Display

0.7069

40.5000

Radians.

40.5 degrees (decimal fraction).

Logarithmic Functions

Natural Logarithm. Pressing \boxed{g} \boxed{LN} calculates the natural logarithm of the number in the display; that is, the logarithm to the base e .

Natural Antilogarithm. Pressing $\boxed{e^x}$ calculates the natural antilogarithm of the number in the display; that is, raises e to the power of that number.

Common Logarithm. Pressing \boxed{g} \boxed{LOG} calculates the common logarithm of the number in the display; that is, the logarithm to the base 10.

Common Antilogarithm. Pressing $\boxed{10^x}$ calculates the common antilogarithm of the number in the display; that is, raises 10 to the power of that number.

| Keystrokes | Display | |
|-----------------------------------|----------------|----------------------------|
| 45 \boxed{g} \boxed{LN} | 3 . 8067 | Natural log of 45. |
| 3.4012 $\boxed{e^x}$ | 30 . 0001 | Natural antilog of 3.4012. |
| 12.4578 \boxed{g} \boxed{LOG} | 1 . 0954 | Common log of 12.4578. |
| 3.1354 $\boxed{10^x}$ | 1 , 365 . 8405 | Common antilog of 3.1354. |

Hyperbolic Functions

Given x in the display (X-register):

| Pressing | Calculates |
|--|-----------------------------------|
| \boxed{f} \boxed{HYP} \boxed{SIN} | hyperbolic sine of x |
| \boxed{g} $\boxed{HYP^{-1}}$ \boxed{SIN} | inverse hyperbolic sine of x |
| \boxed{f} \boxed{HYP} \boxed{COS} | hyperbolic cosine of x |
| \boxed{g} $\boxed{HYP^{-1}}$ \boxed{COS} | inverse hyperbolic cosine of x |
| \boxed{f} \boxed{HYP} \boxed{TAN} | hyperbolic tangent of x |
| \boxed{g} $\boxed{HYP^{-1}}$ \boxed{TAN} | inverse hyperbolic tangent of x |

Two-Number Functions

The HP 15c performs two-number math functions using two values entered sequentially into the display. If you are *keying in* both numbers, remember that they must be separated by **ENTER** or any other function—like **g** **INT** or **1/x**—that terminates digit entry.

For a two-number function, the first value entered is considered the y -value because it is placed into the Y-register for memory storage. The second value entered is considered the x -value because it remains in the display, which is the X-register.

The arithmetic operators, **+**, **-**, **×**, and **÷**, are the four basic two-number functions. Others are given below.

The Power Function

Pressing **y^x** calculates the value of y raised to the x power. The base number, y , is keyed in before the exponent, x .

| To Calculate | Keystrokes | Display |
|----------------------------|--|---------|
| $2^{1.4}$ | 2 ENTER 1.4 y^x | 2.6390 |
| $2^{-1.4}$ | 2 ENTER 1.4 CHS y^x | 0.3789 |
| $(-2)^3$ | 2 CHS ENTER 3 y^x | -8.0000 |
| $\sqrt[3]{2}$ or $2^{1/3}$ | 2 ENTER 3 1/x y^x | 1.2599 |

Percentages

The percentage functions, **%** and **Δ%**, preserve the value of the original base number along with the result of the percentage calculation. As shown in the example below, this allows you to carry out subsequent calculations using the base number and the result without re-entering the base number.

Percent. The **%** function calculates the specified percentage of a base number.

30 Section 2: Numeric Functions

For example, to find the sales tax at 3% and total cost of a \$15.76 item:

| Keystrokes | Display | |
|---------------------|---------|--|
| 15.76 ENTER | 15.7600 | Enters the base number (the price). |
| 3 g % | 0.4728 | Calculates 3% of \$15.76 (the tax). |
| + | 16.2328 | Total cost of item (\$15.76 + \$0.47). |

Percent Difference. The **Δ%** function calculates the percent *difference* between two numbers. The result expresses the relative increase (a positive result) or decrease (a negative result) of the second number entered compared to the first number entered.

For example, suppose the \$15.76 item only cost \$14.12 last year. What is the percent difference in last year's price relative to *this* year's?

| Keystrokes | Display | |
|--------------------------|----------|--|
| 15.76 ENTER | 15.7600 | This year's price (our base number) |
| 14.12 g Δ% | -10.4061 | Last year's price was 10.41% less than <i>this</i> year's price. |

Polar and Rectangular Coordinate Conversions

The **→P** and **→R** functions are provided in the HP 15c for conversions between polar coordinates and rectangular coordinates.

The angle θ is assumed to be in the units set by the current trigonometric mode, whether degrees (in a decimal format, not a minutes-seconds format), radians, or grads. θ is measured as shown in the illustration at right.

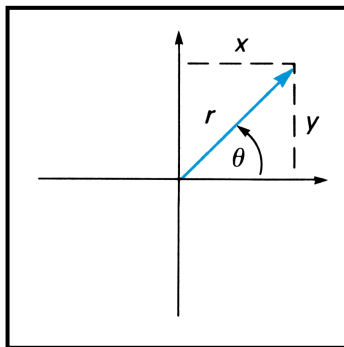

Polar Conversion. Pressing **g** **→P** (*polar*) converts a set of rectangular coordinates (x, y) to polar coordinates (magnitude r , angle θ). The y -value must be entered first, the x -value second. Upon executing **g** **→P**, r will appear in the display. Press **X↔Y** (*X exchange Y*) to bring θ out of the Y-register and into the display (X-register). θ will be returned as a value between -180° and 180° , between $-\pi$ and π radians, or between -200 and 200 grads.

Rectangular Conversion. Pressing $\boxed{f} \boxed{\rightarrow R}$ (*rectangular*) converts a set of polar coordinates (magnitude r , angle θ) into rectangular coordinates (x, y) . θ must be entered first, then r . Upon executing $\boxed{f} \boxed{\rightarrow R}$, x will be displayed first; press $\boxed{x \rightleftharpoons y}$ to display y .

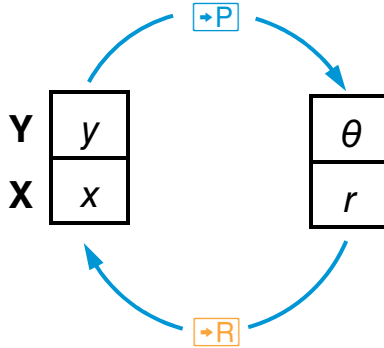

| Keystrokes | Display | |
|-----------------------------------|---------|---|
| $\boxed{g} \boxed{DEG}$ | | Set to Degrees mode (no annunciator). |
| 5 \boxed{ENTER} | 5.0000 | y -value. |
| 10 | 10 | x -value. |
| $\boxed{g} \boxed{\rightarrow P}$ | 11.1803 | r . |
| $\boxed{x \rightleftharpoons y}$ | 26.5651 | θ ; rectangular coordinates converted to polar coordinates. |
| 30 \boxed{ENTER} | 30.0000 | θ . |
| 12 | 12 | r . |
| $\boxed{f} \boxed{\rightarrow R}$ | 10.3923 | x -value. |
| $\boxed{x \rightleftharpoons y}$ | 6.0000 | y -value. Polar coordinates converted to rectangular coordinates. |

Section 3

The Automatic Memory Stack, LAST X, and Data Storage

The Automatic Memory Stack and Stack Manipulation

HP operating logic is based on a mathematical logic known as “Polish Notation”, developed by the noted Polish logician Jan Łukasiewicz (*Wookashye'veech*) (1878–1956). Conventional algebraic notation places the algebraic operators *between* the relevant numbers or variables when evaluating algebraic expressions. Łukasiewicz’s notation specifies the operators *before* the variables. For optimal efficiency of calculator use, HP applied the convention of specifying (entering) the operators *after* specifying (entering) the variable(s). Hence the term “Reverse Polish Notation” (RPN).

The HP 15c uses RPN to solve complicated calculations in a straightforward manner, without parentheses or punctuation. It does so by automatically retaining and returning intermediate results. This system is implemented through the automatic memory stack and the **ENTER** key, minimizing total keystrokes.

The Automatic Memory Stack Registers

| | |
|---|--------|
| T | 0.0000 |
| Z | 0.0000 |
| Y | 0.0000 |
| X | 0.0000 |

Always displayed.

When the HP 15c is in Run mode (no **PRGM** annunciator displayed), the number that appears in the display is the number in the X-register.

Any number that is keyed in or results from the execution of a numeric function is placed into the display (X-register). This action will cause numbers already in the stack to lift, remain in the same register, or drop, depending upon both the immediately preceding and the current operation. Numbers in the stack are stored on a last-in, first-out basis. The three stacks drawn below illustrate the three types of stack movement. Assume x , y , z , and t represent any numbers which may be in the stack.

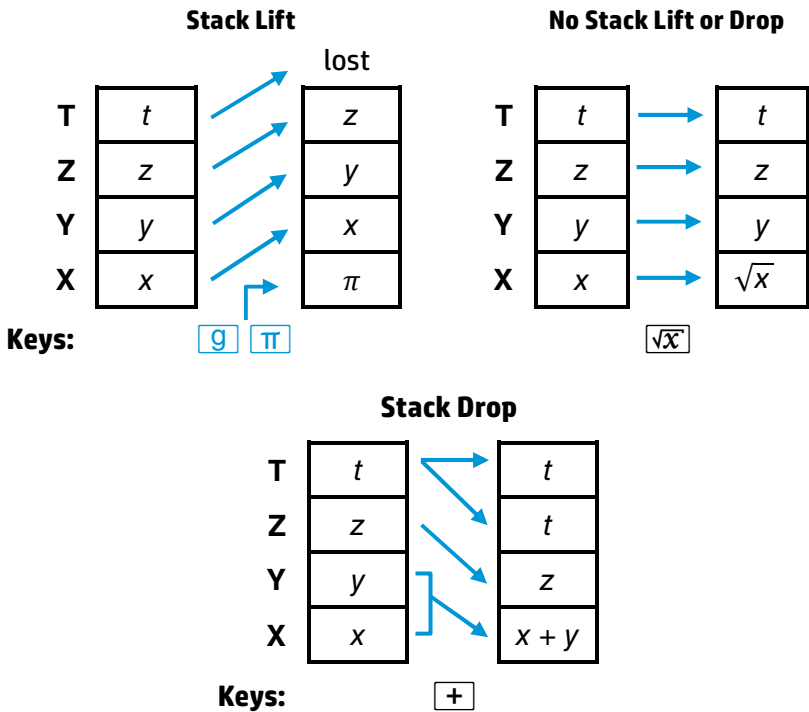

Notice the number in the T-register remains there when the stack drops, allowing this number to be used repetitively as an arithmetic constant.

Stack Manipulation Functions

[ENTER]. Pressing **[ENTER]** separates two numbers keyed in one after the other. It does so by lifting the stack and copying the number in the display (X-register) into the Y-register. The next number entered then writes over the value in the X-register; there is no stack lift. The example below shows

34 Section 3: The Memory Stack, LAST X, and Data Storage

what happens as the stack is filled with the numbers 1, 2, 3, 4. (The shading indicates that the contents of that register will be written over when the next number is keyed in or recalled.)

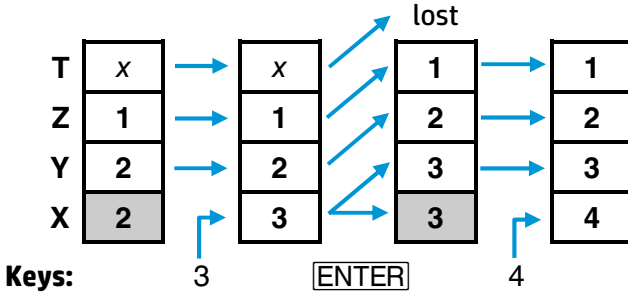
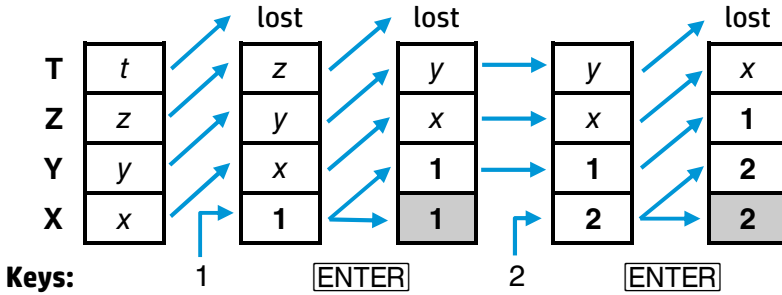

$\boxed{R\downarrow}$ (roll down), $\boxed{R\uparrow}$ (roll up), and $\boxed{X\rightleftharpoons Y}$ (X exchange Y). $\boxed{R\downarrow}$ and $\boxed{R\uparrow}$ roll the contents of the stack registers up or down one register (one value moves between the X- and the T-register). No values are lost. $\boxed{X\rightleftharpoons Y}$ exchanges the numbers in the X- and Y-registers. If the stack were loaded with the sequence 1, 2, 3, 4, the following shifts would result from pressing $\boxed{R\downarrow}$, $\boxed{R\uparrow}$, and $\boxed{X\rightleftharpoons Y}$.

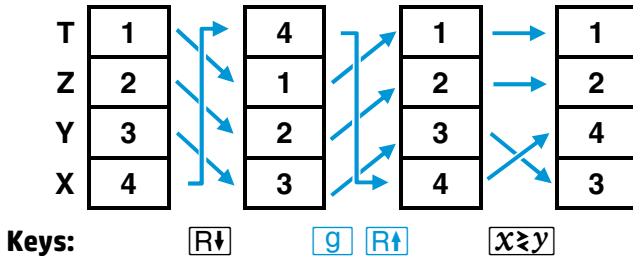

The LAST X Register and **LSTX**

The LAST X register, a separate memory register, preserves the value that was last in the display *before execution of a numeric operation*.^{*} Pressing **g** **LSTX** (LAST X) places a copy of the contents of the LAST X register into the display (X-register). For example:

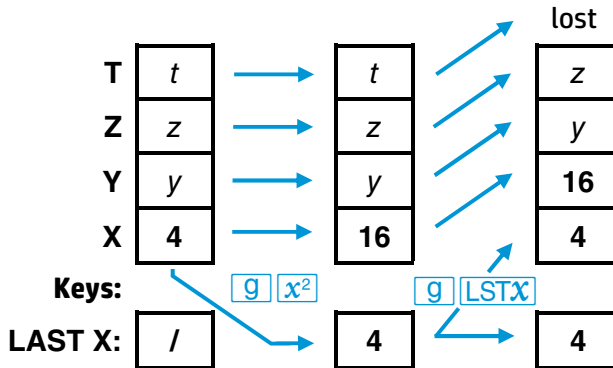

The **LSTX** feature saves you from having to re-enter numbers you want to use again (as shown under Arithmetic Calculations With Constants, page 39). It can also assist you in error recovery, such as executing the wrong function or keying in the wrong number.

For example, suppose you mistakenly entered the wrong divisor in a chain calculation:

| Keystrokes | Display |
|----------------------|----------|
| 287 ENTER | 287.0000 |
| 12.9 ÷ | 22.2481 |
| g LSTX | 12.9000 |

Oops! The wrong divisor.

Retrieves from LAST X the last entry to the X-register (the incorrect divisor) before **÷** was executed.

^{*} Unless that operation was **∫**, **S**, or **LR**, which don't use or preserve the value in the display (X-register), but instead calculate from data in the statistics storage registers (R₂ to R₇). For a complete list of operations which save x in LAST X, refer to Appendix B.

36 Section 3: The Memory Stack, LAST X, and Data Storage

Keystrokes

Display

$\boxed{\times}$

287 . 0000

Reverses the function that produced the wrong answer.

13.9 $\boxed{\div}$

20 . 6475

The correct answer.

Calculator Functions and the Stack

When you want to key in two numbers, one after the other, you press $\boxed{\text{ENTER}}$ between entries of the numbers. However, when you want to key in a number immediately following any function (including manipulations like $\boxed{\text{R}\downarrow}$), you do not need to use $\boxed{\text{ENTER}}$. Why? Executing most HP 15c functions has this additional effect:

- The automatic memory stack is *lift-enabled*; that is, the stack will lift automatically when the *next* number is keyed or recalled into the display.
- Digit entry is terminated, so the next number starts a new entry.

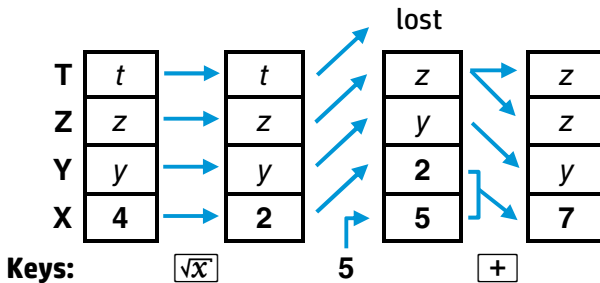

There are four functions— $\boxed{\text{ENTER}}$, $\boxed{\text{CLX}}$, $\boxed{\Sigma+}$, and $\boxed{\Sigma-}$ —that *disable* stack lift.* They do *not* provide for the lifting of the stack when the *next* number is keyed in or recalled. Following the execution of one of these functions, a new number will simply write over the currently displayed number instead of causing the stack to lift. (Although the stack lifts when $\boxed{\text{ENTER}}$ is pressed, it will *not* lift when the *next* number is keyed in or recalled. The operation of $\boxed{\text{ENTER}}$ illustrated on page 34 shows how $\boxed{\text{ENTER}}$ thus disables the stack.) In most cases, the above effects will come so naturally that you won't even think about them.

* $\boxed{\leftarrow}$ will also disable the stack lift *if digit entry is terminated*, making $\boxed{\leftarrow}$ clear the entire display like $\boxed{\text{CLX}}$. Otherwise, it is neutral. For a further discussion of the stack, refer to Appendix B.

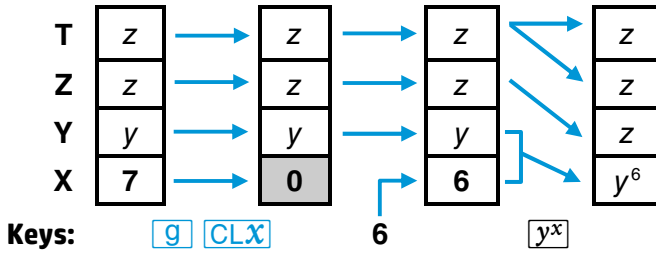

Order of Entry and the ENTER Key

An important aspect of two-number functions is the positioning of the numbers in the stack. To execute an arithmetic function, the numbers should be positioned in the stack in the same way that you would vertically position them on paper. For example:

$$\begin{array}{r} 98 \\ -15 \\ \hline \end{array} \qquad \begin{array}{r} 98 \\ +15 \\ \hline \end{array} \qquad \begin{array}{r} 98 \\ \times 15 \\ \hline \end{array} \qquad \begin{array}{r} 98 \\ 15 \\ \hline \end{array}$$

As you can see, the first (or top) number would be in the Y-register, while the second (or bottom) number would be in the X-register. When the mathematics operation is performed, the stack drops, leaving the result in the X-register. Here is how a subtraction operation is executed in the calculator:

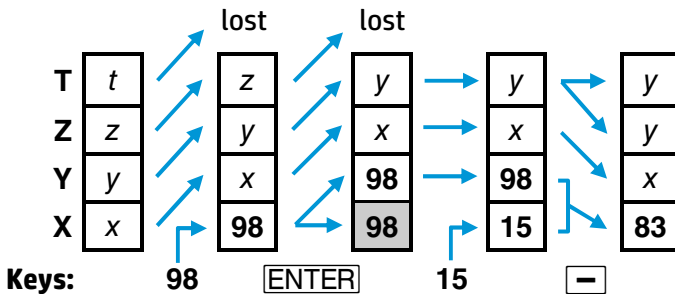

The same number positioning would be used to add 15 to 98, multiply 98 by 15, or divide 98 by 15.

Nested Calculations

The automatic stack lift and stack drop make it possible to do nested calculations without using parentheses or storing intermediate results. A nested calculation is solved simply as a series of one- and two-number operations.

Almost every nested calculation you are likely to encounter can be done using just the four stack registers. It is usually wisest to begin the calculation at the innermost number or pair of parentheses and work outward (as you would for a manual calculation). Otherwise, you may need to place an intermediate result into a storage register. For example, consider the calculation of

$$3 [4 + 5 (6 + 7)] :$$

| Keystrokes | Display | |
|---|----------------|---|
| 6 <input type="text" value="ENTER"/> 7 <input type="text" value="+"/> | 13.0000 | Intermediate result of (6+7). |
| 5 <input type="text" value="X"/> | 65.0000 | Intermediate result of 5 (6 + 7). |
| 4 <input type="text" value="+"/> | 69.0000 | Intermediate result of [4 + 5 (6 + 7)]. |
| 3 <input type="text" value="X"/> | 207.0000 | Final result: 3 [4 + 5 (6 + 7)]. |

The following sequence illustrates the stack manipulation in this example. The stack automatically drops after each two-number calculation, and then lifts when a new number is keyed in. (For simplicity, throughout the rest of this handbook we will not show arrows between the stacks.)

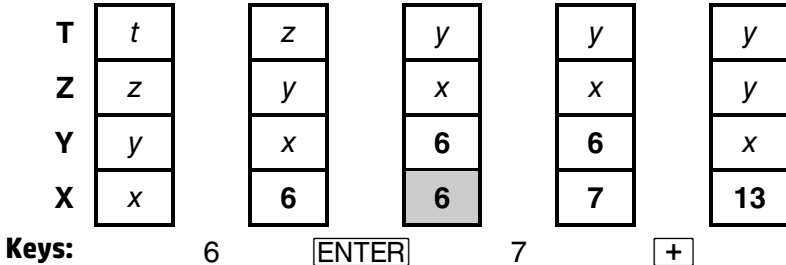

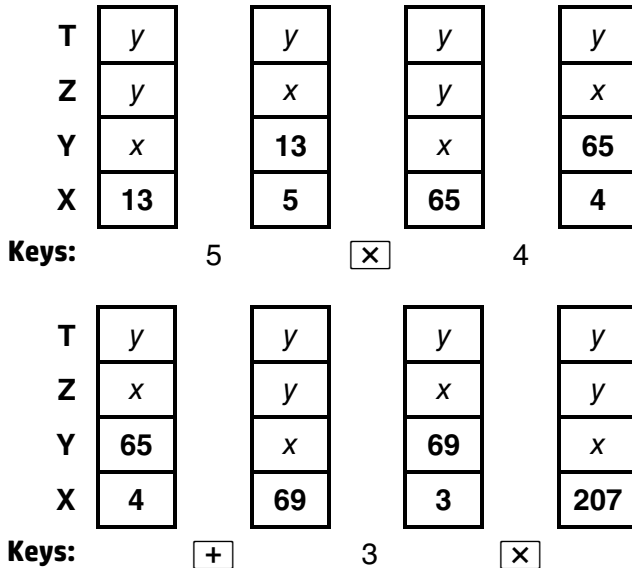

Arithmetic Calculations With Constants

There are three ways (without using a storage register) to manipulate the memory stack to perform repeated calculations with a constant:

1. Use the LAST X register.
2. Load the stack with a constant and operate upon different numbers. (Clear the X-register every time you want to change the number operated upon.)
3. Load the stack with a constant and operate upon an *accumulating* number. (Do *not* change the number in the X-register.)

LAST X. Use your constant in the X-register (that is, enter it second) so that it always will be saved in the LAST X register. Pressing 9 LSTX will retrieve the constant and place it into the X-register (the display). This can be done repeatedly.

40 Section 3: The Memory Stack, LAST X, and Data Storage

Example: Two close stellar neighbors of Earth are Rigel Centaurus (4.3 light-years away) and Sirius (8.7 light-years away). Use the speed of light, c (3.0×10^8 meters/second, or 9.5×10^{15} meters/year), to figure the distances to these stars in meters. (The stack diagrams show only one decimal place.)

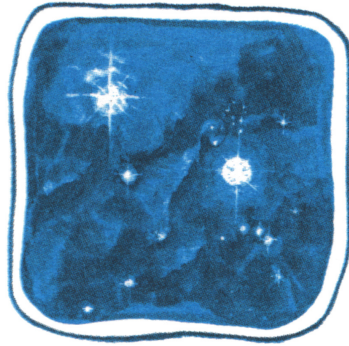

| | | | | |
|---|---|-----|-----|--------|
| T | t | z | y | y |
| Z | z | y | x | x |
| Y | y | x | 4.3 | 4.3 |
| X | x | 4.3 | 4.3 | 9.5 15 |

Keys: 4.3 **ENTER** 9.5 **EEX** 15

LAST X: / / / /

| | | | | |
|---|--------|--------|--------|--------|
| T | y | y | y | x |
| Z | x | y | x | 4.1 16 |
| Y | 4.3 | x | 4.1 16 | 8.7 |
| X | 9.5 15 | 4.1 16 | 8.7 | 9.5 15 |

Keys: **x** 8.7 **g** **LSTX**

LAST X: / 9.5 15 9.5 15 9.5 15

| | | |
|---|--------|--------|
| T | x | x |
| Z | 4.1 16 | x |
| Y | 8.7 | 4.1 16 |
| X | 9.5 15 | 8.3 16 |

Keys: **x**

LAST X: 9.5 15 9.5 15

← (Rigel Centaurus is 4.1×10^{16} meters away.)

← (Sirius is 8.3×10^{16} meters away.)

Loading the Stack with a Constant. Because the number in the T-register is replicated when the stack drops, this number can be used as a constant in arithmetic operations.

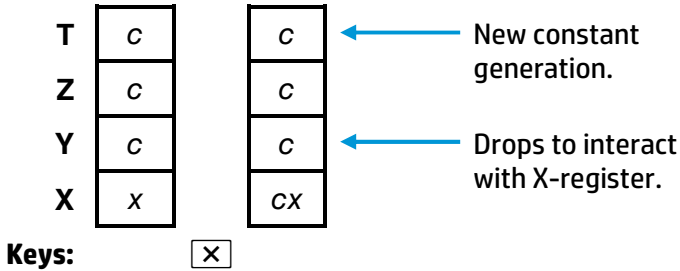

Fill the stack with a constant by keying it into the display and pressing **ENTER** three times. Key in your initial argument and perform the arithmetic operation. The stack will drop, a copy of the constant will “fall” into the Y-register, and a new copy of the constant will be generated in the T-register.

If the variables change (as in the preceding example), be sure to clear the display before entering the new variable. This disables the stack so that the arithmetic result will be written over and only the constant will occupy the rest of the stack.

If you do *not* have different arguments, that is, the operation will be performed upon a *cumulative* number, then do *not* clear the display—simply repeat the arithmetic operation.

Example: A bacteriologist tests a certain strain of microorganisms whose population typically increases by 15% each day (a growth factor of 1.15). If she starts with a sample culture of 1000, what will be the bacteria population at the end of each day for four consecutive days?



| Keystrokes | Display | |
|--|----------|-----------------------|
| 1.15 | 1 . 15 | Growth factor. |
| ENTER ENTER ENTER | 1 . 1500 | Filling the stack. |
| 1000 | 1 , 000 | Initial culture size. |

| Keystrokes | Display | |
|------------------|------------|---------------------------------|
| $\boxed{\times}$ | 1,150.0000 | Population at the end of day 1. |
| $\boxed{\times}$ | 1,322.5000 | Day 2. |
| $\boxed{\times}$ | 1,520.8750 | Day 3. |
| $\boxed{\times}$ | 1,749.0063 | Day 4. |

Storage Register Operations

When numbers are stored or recalled, they are copied between the display (X-register) and the data storage registers. At “power-up” (initial turn-on or Continuous Memory reset) the HP 15c has 21 directly accessible storage registers: R_0 through R_9 , $R_{.0}$ through $R_{.9}$, and the Index register (R_i) (see the diagram of the registers on page 76). Six registers, R_2 to R_7 , are also used for statistics calculations.

The number of available data storage registers can be increased or decreased. The $\boxed{\text{DIM}}$ function, which is used to reallocate registers in calculator memory, is discussed in Appendix C, Memory Allocation. The lowest-numbered registers are the last to be deallocated from data storage, *therefore it is wisest to store data in the lowest-numbered registers available.*

Storing and Recalling Numbers

$\boxed{\text{STO}}$ (*store*). When followed by a storage register address (0 through 9 or $.0$ through $.9$ *), this function copies a number from the display (X-register) into the specified data storage register. It will replace any existing contents of that register.

$\boxed{\text{RCL}}$ (*recall*). Similarly, you can recall data from a particular register into the display by pressing $\boxed{\text{RCL}}$ followed by the register address. This brings a *copy* of the desired data into the display; the contents of the storage register remain unaltered.

$\boxed{\times\rightleftharpoons}$ (*X exchange*). Followed by 0 through $.9$ *, this function *exchanges the contents* of the X-register and the addressed data storage register. This is useful to view storage registers without disturbing the stack.

* All storage register operations can also be performed with the Index register (using $\boxed{\text{I}}$ or $\boxed{\text{(i)}}$), which is covered in Section 10, and with matrices, Section 12.

The above are stack lift-enabling operations, so the number remaining in the X-register can be used for subsequent calculations. If you address a nonexistent register, the display will show **Error 3**.

Example: Springtime is coming and you want to keep track of 24 crocuses planted in your garden. Store the number of crocuses blooming the first day and add to this the number of new blooms the second day.

| Keystrokes | Display | |
|--------------------------|----------|---|
| 3 $\boxed{\text{STO}}$ 0 | 3 . 0000 | Stores the number of first-day blooms in R_0 . |
| $\boxed{\text{RCL}}$ 0 | 3 . 0000 | Recalls the number of crocuses that bloomed yesterday. |
| 5 $\boxed{+}$ | 8 . 0000 | Adds today's new blooms to get the total blooming crocuses. |

Turn the calculator off. Next day, turn it back on again.

Clearing Data Storage Registers

Pressing $\boxed{\text{f}}$ **CLEAR** $\boxed{\text{REG}}$ (*clear registers*) clears the contents of *all* data storage registers to zero. (It does not affect the stack or the LAST X register.) To clear a single data storage register, store zero in that register. Resetting Continuous Memory clears all registers and the stack.

Storage and Recall Arithmetic

Storage Arithmetic. Suppose you not only wanted to store a number, but perform arithmetic with it and store the result in the same register. You can do this directly—without using $\boxed{\text{RCL}}$ —by using the following procedure.

1. Have your second operand (besides the one in storage) in the display (as the result of a calculation, a recall, or keying in).
2. Press $\boxed{\text{STO}}$.
3. Press $\boxed{+}$, $\boxed{-}$, $\boxed{\times}$, or $\boxed{\div}$.
4. Key in the register address (0 to 9, .0 to .9). (The Index register, discussed in Section 10, can also be used.)

44 Section 3: The Memory Stack, LAST X, and Data Storage

The number in the register is determined as follows:

For storage arithmetic,

$$\text{new contents of register} = \text{old contents of register} \left\{ \begin{array}{l} + \\ - \\ \times \\ \div \end{array} \right\} \text{number in display}$$

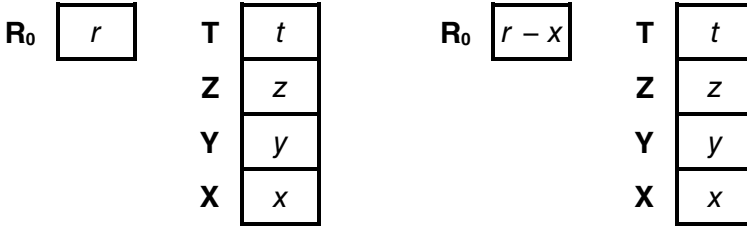

Keys: STO - 0

Recall Arithmetic. Recall arithmetic allows you to perform arithmetic with the displayed value and a stored value *without lifting the stack*, that is, without losing any values from the Y-, Z, and T-registers. The keystroke sequence is the same as for storage arithmetic using RCL in place of STO.

For recall arithmetic,

$$\text{new display} = \text{old display} \left\{ \begin{array}{l} + \\ - \\ \times \\ \div \end{array} \right\} \text{contents of register}$$

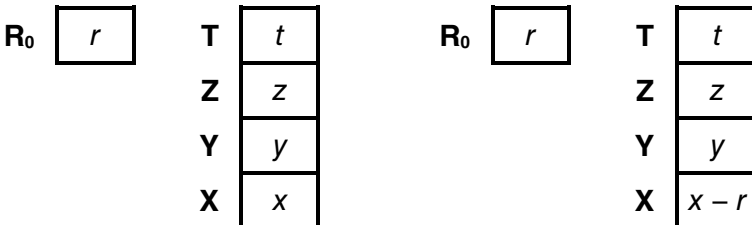

Keys: RCL - 0

Example: Keep a running count of your newly blooming crocuses for two more days.

| Keystrokes | Display | |
|---------------------------------------|-----------|--|
| 8 $\boxed{\text{STO}}$ 0 | 8 . 0000 | Places the total number of blooms as of day 2 in R_0 . |
| 4 $\boxed{\text{STO}}$ $\boxed{+}$ 0 | 4 . 0000 | Day 3: adds four new blooms to those already blooming. |
| 3 $\boxed{\text{STO}}$ $\boxed{+}$ 0 | 3 . 0000 | Day 4: adds three new blooms. |
| 24 $\boxed{\text{RCL}}$ $\boxed{-}$ 0 | 9 . 0000 | Subtracts total number of blooms summed in R_0 (15) from the total number of plants (24): 9 crocuses have not bloomed. |
| $\boxed{\text{RCL}}$ 0 | 15 . 0000 | (The number in R_0 does not change.) |

Overflow and Underflow

If an attempted storage or recall arithmetic operation would result in overflow in a data storage register, the value in the affected register will be replaced with $\pm 9.99999999 \times 10^{99}$ and the display will blink. To stop the blinking (clear the overflow condition), press $\boxed{\leftarrow}$ or $\boxed{\text{ON}}$ or $\boxed{9}$ $\boxed{\text{CF}}$.

In case of underflow, the value in the register will be replaced with zero (no display blinking). Overflow and underflow are discussed further on page 61.

Problems

- Calculate the value of x in the following equation.

$$x = \sqrt{\frac{8.33(4 - 5.2) \div [(8.33 - 7.46)0.32]}{4.3(3.15 - 2.75) - (1.71)(2.01)}}$$

Answer: 4.5728.

A possible keystroke solution is:

4 $\boxed{\text{ENTER}}$ 5.2 $\boxed{-}$ 8.33 $\boxed{\times}$ $\boxed{9}$ $\boxed{\text{LSTX}}$ 7.46 $\boxed{-}$ 0.32
 $\boxed{\times}$ $\boxed{\div}$ 3.15 $\boxed{\text{ENTER}}$ 2.75 $\boxed{-}$ 4.3 $\boxed{\times}$ 1.71 $\boxed{\text{ENTER}}$
 2.01 $\boxed{\times}$ $\boxed{-}$ $\boxed{\div}$ $\boxed{\sqrt{x}}$

46 Section 3: The Memory Stack, LAST X, and Data Storage

2. Use arithmetic with constants to calculate the remaining balance of a \$1000 loan after six payments of \$100 each and an interest rate of 1% (0.01) per payment period.

Procedure: Load the stack with $(1 + i)$, where i = interest rate, and key in the initial loan balance. Use the following formula to find the new balance after each payment.

$$\text{New Balance} = ((\text{Old Balance}) \times (1 + i)) - \text{Payment}$$

The first part of the key sequence would be:

1.01 1000

For each payment, execute:

100

Balance after six payments: \$446.32.

3. Store 100 in R_5 . Then:
1. Divide the contents of R_5 by 25.
 2. Subtract 2 from the contents of R_5 .
 3. Multiply the contents of R_5 by 0.75.
 4. Add 1.75 to the contents of R_5 .
 5. Recall the contents of R_5 .

Answer: 3.2500.

A possible keystroke solution is:

100 5
25 5
2 5
0.75 5
1.75 5
 5

Section 4

Statistics Functions

A word about the statistics functions: their use is based on an understanding of memory stack operation (Section 3). You will find that order of entry is important for most statistics calculations.

Probability Calculations

The input for permutation and combination calculations is restricted to *nonnegative integers*. Enter the y -value before the x -value. These functions, like the arithmetic operators, cause the stack to drop as the result is placed in the X-register.

Permutations. Pressing \boxed{f} $\boxed{P_{y,x}}$ calculates the number of possible different *arrangements* of y different items taken in quantities of x items at a time. No item occurs more than once in an arrangement, and different orders of the same x items in an arrangement *are* counted separately. The formula is

$$P_{y,x} = \frac{y!}{(y-x)!}$$

Combinations. Pressing \boxed{g} $\boxed{C_{y,x}}$ calculates the number of possible *sets* of y different items taken in quantities of x items at a time. No item occurs more than once in a set, and different orders of the same x items in a set are *not* counted separately. The formula is

$$C_{y,x} = \frac{y!}{x!(y-x)!}$$

Examples: How many different arrangements are possible of five pictures which can be hung on the wall three at a time?

| Keystrokes | Display |
|-------------------------------|--|
| 5 $\boxed{\text{ENTER}}$ 3 | 3 Five (y) pictures put up three (x) at a time. |
| \boxed{f} $\boxed{P_{y,x}}$ | 60 . 0000 Sixty different arrangements possible. |

48 Section 4: Statistics Functions

How many different four-card hands can be dealt from a deck of 52 cards?

| Keystrokes | Display | |
|----------------------|--------------|---|
| 52 ENTER 4 | 4 | Fifty-two (y) cards dealt four (x) at a time. |
| g Cy,x | 270,725.0000 | Number of different hands possible. |

The maximum size of x or y is 9,999,999,999.

Random Number Generator

Pressing **f** **RAN#** (*random number*) will generate a random number (part of a uniformly distributed pseudo-random number sequence) in the range $0 \leq r < 1$.*

At initial power-up (including reset of Continuous Memory), the HP 15c random number generator will use zero as a “seed” to initiate a random number sequence. Any time you generate a random number, that number becomes the seed for the next random number. You can initiate a different random number sequence by storing a new seed for the random number generator. (Repetition of a random number seed will produce repetition of the random number sequence.)

STO **f** **RAN#** will store the X-register number ($0 \leq r < 1$) as a new seed for the random number generator. (A value for r outside this range will be converted to fit within the range.)

RCL **f** **RAN#** will recall to the display the current random number seed.

* Passes the spectral test (D. Knuth, *The Art of Computer Programming, Vol. 2: Seminumerical Algorithms*, Third Edition, 1998).

| Keystrokes | Display | |
|---|---------|--|
| .5764 | 0.5764 | Stores 0.5764 as random number seed. (The \boxed{f} keystroke may be omitted.) |
| $\boxed{\text{STO}}$ \boxed{f} $\boxed{\text{RAN}\#}$ | 0.5764 | |
| \boxed{f} $\boxed{\text{RAN}\#}$ | 0.3422 | Random number sequence initiated by the above seed. |
| \boxed{f} $\boxed{\text{RAN}\#}$ | 0.2809 | |
| $\boxed{\leftarrow}$ | 0.0000 | |
| $\boxed{\text{RCL}}$ \boxed{f} $\boxed{\text{RAN}\#}$ | 0.2809 | Recalls last random number generated, which is the new seed. (The \boxed{f} may be omitted.) |

Accumulating Statistics

The HP 15c performs one- and two-variable statistical calculations. The data is first entered into the Y- and X-registers. Then the $\boxed{\Sigma+}$ function automatically calculates and stores statistics of the data in storage registers R₂ through R₇. These registers are therefore referred to as the *statistics registers*.

Before beginning to accumulate statistics for a new set of data, press \boxed{f} **CLEAR** $\boxed{\Sigma}$ to clear the statistics registers and stack. LAST X is not cleared. (If you have reallocated registers in memory and any of the statistics registers no longer exist, **Error 3** will be displayed when you try to use **CLEAR** $\boxed{\Sigma}$, $\boxed{\Sigma+}$, or $\boxed{\Sigma-}$. Appendix C explains how to reallocate memory.)

In one-variable statistical calculations, enter each data point (*x*-value) by keying in *x* and then press $\boxed{\Sigma+}$.

In two-variable statistical calculations, enter each data pair (the *x*- and *y*-values) as follows:

1. Key *y* into the display first.
2. Press $\boxed{\text{ENTER}}$. The displayed *y*-value is copied into the Y-register.
3. Key *x* into the display.
4. Press $\boxed{\Sigma+}$. The current number of accumulated data points, *n*, will be displayed. The *x*-value is saved in the LAST X register and *y* remains in the Y-register. $\boxed{\Sigma+}$ disables stack lift, so the stack will not lift when the next number is keyed in.

50 Section 4: Statistics Functions

In some cases involving x or y data values that differ by a relatively small amount, the calculator cannot compute s , r , linear regression, or \hat{y} , and will display **Error 2**. This will not happen, however, if you normalize the data by keying in only the difference between each value and the mean or approximate mean of the values. This difference must be added back to the calculations of \bar{x} , \hat{y} , and the y -intercept (**LR**). For example, if your x -values were 665999, 666000, and 666001, you should enter the data as -1 , 0 , and 1 ; then add 666000 back to the relevant results.

The statistics of the data are compiled as follows:

| Register | | Contents |
|----------------|--------------|--|
| R ₂ | n | Number of data points accumulated (n also appears in the X-register). |
| R ₃ | Σx | Summation of x -values. |
| R ₄ | Σx^2 | Summation of squares of x -values. |
| R ₅ | Σy | Summation of y -values. |
| R ₆ | Σy^2 | Summation of squares of y -values. |
| R ₇ | Σxy | Summation of products of x - and y -values. |

You can recall any of the accumulated statistics to the display (X-register) by pressing **RCL** and the number of the data storage register containing the desired statistic. If you press **RCL** **$\Sigma+$** , Σx and Σy will be copied simultaneously from R₃ and R₅ respectively, into the X-register and the Y-register, respectively. (The sequence **RCL** **$\Sigma+$** lifts the stack twice if stack lift is enabled, once if not, and then enables stack lift.)

Example: Agronomist Silas Farmer has developed a new variety of high-yield rice, and has measured the plant's yield as a function of fertilization. Use the **$\Sigma+$** function to accumulate the data below to find the values for Σx , Σx^2 , Σy , Σy^2 , and Σxy for nitrogen fertilizer application (x) versus grain yield (y).



| | | | | | | |
|----------|--|------|-------|-------|-------|-------|
| X | NITROGEN APPLIED (kg per hectare*), x | 0.00 | 20.00 | 40.00 | 60.00 | 80.00 |
| Y | GRAIN YIELD (metric tons per hectare), y | 4.63 | 4.78 | 6.61 | 7.21 | 7.78 |

* A hectare equals 2.47 acres.

Keystrokes**Display**f CLEAR Σ

0 . 0000

Clears statistical storage registers (R₂ through R₇ and the stack).

f FIX 2

0 . 00

Limits display to two decimal places, like the data.

4.63 ENTER

4 . 63

0 $\Sigma+$

1 . 00

First data point.

4.78 ENTER

4 . 78

20 $\Sigma+$

2 . 00

Second data point.

6.61 ENTER

6 . 61

40 $\Sigma+$

3 . 00

Third data point.

7.21 ENTER

7 . 21

60 $\Sigma+$

4 . 00

Fourth data point.

7.78 ENTER

7 . 78

80 $\Sigma+$

5 . 00

Fifth data point.

 \square RCL 3

200 . 00

Sum of x -values, Σx (kg of nitrogen). \square RCL 4

12 . 000 . 00

Sum of squares of x -values, Σx^2 . \square RCL 5

31 . 01

Sum of y -values, Σy (grain yield). \square RCL 6

200 . 49

Sum of squares of y -values, Σy^2 . \square RCL 7

1 , 415 . 00

Sum of products of x - and y -values, Σxy .

Correcting Accumulated Statistics

If you discover that you have entered data incorrectly, the accumulated statistics can be easily corrected. Even if only one value of an (x, y) data pair is incorrect, you must delete and re-enter *both* values.

1. Key the *incorrect* data pair into the Y- and X-registers.
2. Press \boxed{g} $\boxed{\Sigma-}$ to delete the incorrect data.
3. Key in the correct values for x and y .
4. Press $\boxed{\Sigma+}$.

Alternatively, if the incorrect data point or pair is the most recent one entered and $\boxed{\Sigma+}$ has been pressed, you can press \boxed{g} \boxed{LSTX} \boxed{g} $\boxed{\Sigma-}$ to remove the incorrect data.*

Example: After keying in the preceding data, Farmer realizes he misread a smeared figure in his lab book. The second y -value should have been 5.78 instead of 4.78. Correct the data input.

| Keystrokes | Display | |
|----------------------------------|---------|---|
| 4.78 $\boxed{\text{ENTER}}$ | 4 . 78 | Keys in the data pair we want to replace and deletes the accompanying statistics. The n -value drops to four. |
| 20 \boxed{g} $\boxed{\Sigma-}$ | 4 . 00 | |
| 5.78 $\boxed{\text{ENTER}}$ | 5 . 78 | Keys in and accumulates the replacement data pair. |
| 20 $\boxed{\Sigma+}$ | 5 . 00 | The n -value is back to five. |

We will use these statistics in the rest of the examples in this section.

* Note that these methods of data deletion will not delete any rounding errors that may have been generated in the statistics registers. This difference will not be serious unless the erroneous pair has a magnitude that is enormous compared with the correct pair, in such a case, it would be wise to start over!

Mean

The \bar{x} function computes the arithmetic mean (average) of the x - and y -values using the formulas shown in Appendix A and the statistics accumulated in the relevant registers. When you press \bar{g} \bar{x} the contents of the stack lift (two registers if stack lift is enabled, one if not); the mean of x (\bar{x}) is copied into the X-register as the mean of y (\bar{y}) is copied simultaneously into the Y-register. Press $\bar{x}\bar{y}$ to view \bar{y} .

Example: From the corrected statistics data we have already entered and accumulated, calculate the average fertilizer application, \bar{x} , and average grain yield, \bar{y} , for the entire range.

Keystrokes

Display

\bar{g} \bar{x}

40 . 00

Average kg of nitrogen, \bar{x} , for all cases.

$\bar{x}\bar{y}$

6 . 40

Average tons of rice, \bar{y} , for all cases.

Standard Deviation

Pressing \bar{g} \bar{s} computes the *standard deviation* of the accumulated statistics data. The formulas used to compute s_x , the standard deviation of the accumulated x -values, and s_y , the standard deviation of the accumulated y -values, are given in Appendix A.

This function gives an estimate of the population standard deviation from the sample data, and is therefore termed the *sample* standard deviation.* When you press \bar{g} \bar{s} , the contents of the stack registers are lifted (twice if stack lift is enabled, once if not); s_x is placed into the X-register and s_y is placed into the Y-register. Press $\bar{x}\bar{y}$ to view s_y .

* When your data constitutes not just a sample of a population but *all* of the population, the standard deviation of the data is the true population standard deviation (denoted σ). The formula for the true population standard deviation differs by a factor of $\sqrt{(n-1)/n}$ from the formula used for the \bar{s} function. The difference between the values is small for large n , and for most applications can be ignored. But if you want to calculate the exact value of the population standard deviation for an entire population, you can easily do so: simply add, using $\bar{\Sigma}+$, the mean (\bar{x}) of the data to the data before pressing \bar{g} \bar{s} . The result will be the population standard deviation. (If you subsequently correct any of your accumulated data values, remember to delete the first mean value and add the corrected one.)

54 Section 4: Statistics Functions

Example: Calculate the standard deviation about the mean calculated above.

Keystrokes

\boxed{g} \boxed{s}

Display

31 . 62

Standard deviation about the mean nitrogen application, \bar{x} .

$\boxed{x\bar{z}y}$

1 . 24

Standard deviation about the mean grain yield, \bar{y} .

Linear Regression

Linear regression is a statistical method for finding a straight line that best fits a set of two or more data pairs, thus providing a relationship between two variables. By the method of least squares, \boxed{f} $\boxed{L.R.}$ will calculate the slope, A , and y -intercept, B , of the linear equation:

$$y = Ax + B$$

1. Accumulate the statistics of your data using the $\boxed{\Sigma+}$ key.
2. Press \boxed{f} $\boxed{L.R.}$. The y -intercept, B , appears in the display (X-register). The slope, A , is copied simultaneously into the Y-register.
3. Press $\boxed{x\bar{z}y}$ to view A . (As is the case with the functions $\boxed{\bar{x}}$ and \boxed{s} , $\boxed{L.R.}$ causes the stack to lift two registers if it's enabled, one if not.)

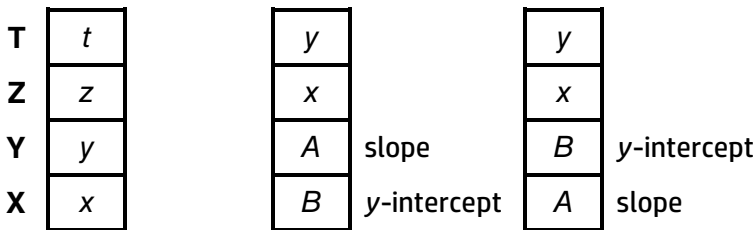

Keys:

\boxed{f} $\boxed{L.R.}$

$\boxed{x\bar{z}y}$

The slope and y -intercept of the least squares line of the accumulated data are calculated using the equations shown in Appendix A.

Example: Find the y -intercept and slope of the linear approximation of the data and compare to the plotted data on the graph below.

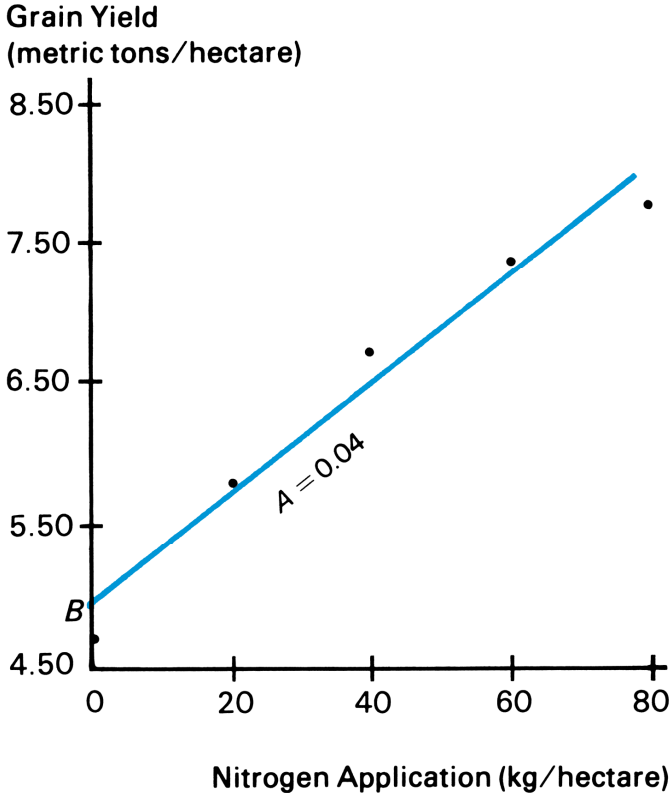
**Keystrokes**
 \boxed{f} $\boxed{L.R.}$
 $\boxed{X \hat{=} Y}$
Display

4 . 86

0 . 04

 y -intercept of the line.

Slope of the line.

Linear Estimation and Correlation Coefficient

When you press \boxed{f} $\boxed{\hat{y}, r}$ the *linear estimate*, \hat{y} , is placed in the X-register and the *correlation coefficient*, r , is placed in the Y-register. To display r , press $\boxed{X \hat{=} Y}$.

56 Section 4: Statistics Functions

Linear Estimation. With the statistics accumulated, an estimated value for y , denoted \hat{y} , can be calculated by keying in a proposed value for x and pressing $\boxed{f} \boxed{\hat{y},r}$.

An Estimated value for x (denoted \hat{x}) can be calculated as follows:

1. Press $\boxed{f} \boxed{LR}$.
2. Key in the known y -value.
3. Press $\boxed{x\hat{y}} \boxed{-} \boxed{x\hat{y}} \boxed{\div}$.

Correlation Coefficient. Both linear regression and linear estimation presume that the relationship between the x and y data values can be approximated by a linear function. The correlation coefficient, r , is a determination of how closely your data fit a straight line. The range is $-1 \leq r \leq 1$, with -1 representing a perfectly negative correlation and $+1$ representing a perfectly positive correlation.

Note that if you do not key in a value for x before executing $\boxed{f} \boxed{\hat{y},r}$, the number previously in the X-register will be used (usually yielding a meaningless value for \hat{y}).

Example: What if 70 kg of nitrogen fertilizer were applied to the rice field? Predict the grain yield based on Farmer's accumulated statistics. Because the correlation coefficient is automatically included in the calculation, you can view how closely the data fit a straight line by pressing $\boxed{x\hat{y}}$ after the y prediction appears in the display.

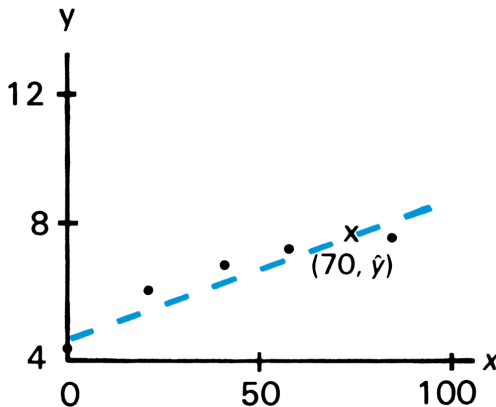

| Keystrokes | Display | |
|------------------------------------|---------|---|
| 70 \boxed{f} $\boxed{\hat{y},r}$ | 7.56 | Predicted grain yield in tons/hectare. |
| $\boxed{x \approx y}$ | 0.99 | The original data closely approximates a straight line. |

Other Applications

Interpolation. Linear interpolation of tabular values, such as in thermodynamics and statistics tables, can be carried out very simply on the HP 15c by using the $\boxed{\hat{y},r}$ function. This is because linear interpolation *is* linear estimation: two consecutive tabular values are assumed to form two points on a line, and the unknown intermediate value is assumed to fall on that same line.

Vector Arithmetic. The statistical accumulation functions can be used to perform vector addition and subtraction. Polar vector coordinates must be converted to rectangular coordinates upon entry (θ , $\boxed{\text{ENTER}}$, r , $\boxed{\rightarrow R}$, $\boxed{\Sigma+}$). The results are recalled from R_3 (Σx) and R_5 (Σy) (using $\boxed{\text{RCL}}$ $\boxed{\Sigma+}$) and converted back to polar coordinates, if necessary. Remember that for polar coordinates the angle is between -180° and 180° (or $-\pi$ and π radians, or -200 and 200 grads). To convert to a positive angle, add 360 (or 2π or 400) to the angle.

For the second vector entered, the final keystroke will be *either* $\boxed{\Sigma+}$ or $\boxed{\Sigma-}$, depending on whether the two vectors should be added or subtracted.

Section 5

The Display and Continuous Memory

Display Control

The HP 15c has three display formats—**FIX**, **SCI**, and **ENG**—that use a given number (0 through 9) to specify display format. The illustration below shows how the number 123,456 would be displayed specified to four places in each possible mode.

| | | | |
|---------------------|---|---|--------------|
| f FIX | 4 | : | 123,456.0000 |
| f SCI | 4 | : | 1.2346 05 |
| f ENG | 4 | : | 123.46 03 |

Owing to Continuous Memory, any change you make in the display format will be preserved until Continuous Memory is reset.

The current display format takes effect when digit entry is terminated; until then, all digits you key in (up to 10) are displayed.

Fixed Decimal Display

FIX (*fixed decimal*) format displays a figure with the number of decimal places you specify (up to nine, depending on the size of the integer portion.) Exponents will be displayed if the number is too small or too large for the display. At “power-up”, the HP 15c is in **FIX** 4 format. The key sequence is **f** **FIX** *n*.

| Keystrokes | Display | |
|-----------------------|-------------|--|
| 123.4567895 | 123.4567895 | |
| f FIX 4 | 123.4568 | |
| f FIX 6 | 123.456790 | Display is rounded to six decimal places. (Ten places are stored internally.) |
| f FIX 4 | 123.4568 | Usual FIX 4 display. |

Scientific Notation Display

SCI (*scientific*) format displays a number in scientific notation. The

sequence **f** **SCI** *n* specifies the number of decimal places to be shown. Up to six decimal places can be shown since the exponent display takes three spaces. The display will be rounded to the specified number of decimal places; however, if you specify more decimal places than the six places the display can hold (that is, **SCI** 7, 8, or 9), rounding will occur in the *undisplayed* seventh, eighth, or ninth decimal place.*

With the previous number still in the display:

| Keystrokes | Display | |
|-----------------------|----------------|--|
| f SCI 6 | 1 . 234568 | 02 Rounds to and shows six decimal places. |
| f SCI 8 | 1 . 234567 | 02 Rounds to eight decimal places, but displays only six. |

Engineering Notation Display

ENG (*engineering*) format displays numbers in an engineering notation format in a manner similar to **SCI**, except:

- In engineering notation, the first significant digit is always present in the display. The number you key in after **f** **ENG** specifies the number of *additional* digits to which you want to round the display.
- Engineering notation shows all exponents in multiples of three.

| Keystrokes | Display | |
|-----------------------|----------------|--|
| .012345 | 0 . 012345 | |
| f ENG 1 | 12 . | -03 Rounds to the first digit after the leading digit. |
| f ENG 3 | 12 . 35 | -03 |
| 10 X | 123 . 5 | -03 Decimal shifts to maintain multiple of three in exponent. |
| f FIX 4 | 0 . 1235 | Usual FIX 4 format. |

* Therefore, the display shows no distinction among **SCI** 7, 8, and 9 *unless* the number rounded up is a 9, which carries a 1 over into the next higher decimal place.

Mantissa Display

Regardless of the display format, the HP 15c always internally holds each number as a 10-digit mantissa and a two-digit exponent of 10. For example, π is always represented internally as $3.141592654 \times 10^{00}$, regardless of what is in the display.

When you want to view the full 10-digit mantissa of a number in the X-register, press **f CLEAR PREFIX**. To keep the mantissa in the display, hold the **PREFIX** key down.

Keystrokes

g **π**

f CLEAR PREFIX

(hold)

Display

3 . 1 4 1 6

3 1 4 1 5 9 2 6 5 4

Round-Off Error

As mentioned earlier, the HP 15c holds every value to 10 digits internally. It also rounds the final result of every calculation to the 10th digit. Because the calculator can provide only a finite approximation for numbers such as π or $2/3$ (0.666...), a small error due to rounding can occur. This error can be increased in lengthy calculations, but usually is insignificant. To accurately assess this effect for a given calculation requires numerical analysis beyond our scope and space here! Refer to the *HP 15c Advanced Functions Handbook* for a more detailed discussion.

Special Displays

Annunciators

The HP 15c display contains eight annunciators that indicate the status of the calculator for various operations. The meaning and use of these annunciators is discussed on the following pages:

| | |
|---------------------|--|
| * | Low-power indication, page 62. |
| USER | User mode, pages 79 and 144. |
| f and g | Prefixes for alternate functions, pages 18–19. |
| RAD and GRAD | Trigonometric modes, page 26. |
| C | Complex mode, page 121. |
| PRGM | Program mode, page 66. |

Digit Separators

The HP 15c is set at power-up so that it separates integral and fractional portions of a number with a period (a decimal point), and separates groups of three digits in the integer portion with a comma. You can reverse this setting to conform to the numerical convention used in many countries. To do so, turn off the calculator. Press and hold $\boxed{\text{ON}}$, press and hold $\boxed{\cdot}$, release $\boxed{\text{ON}}$, then release $\boxed{\cdot}$ ($\boxed{\text{ON}} / \boxed{\cdot}$). (Repeating this sequence will set the calculator to the previous display convention.)

| Keystrokes | Display |
|-------------------------------------|-------------|
| 12345.67 | 12,345.67 |
| $\boxed{\text{ON}} / \boxed{\cdot}$ | 12.345,6700 |
| $\boxed{\text{ON}} / \boxed{\cdot}$ | 12,345.6700 |

Error Display

If you attempt an improper operation—such as division by zero—an error message (**Error** followed by a digit) will appear in the display. For a complete listing of error messages and their causes, refer to Appendix A.

To clear the **Error** display and restore the calculator to its prior condition, press any key. You can then resume normal operation.

Overflow and Underflow

Overflow. When the result of a calculation in *any* register is a number with a magnitude greater than $9.999999999 \times 10^{99}$, $\pm 9.999999999 \times 10^{99}$ is placed in the affected register and the overflow flag, flag 9, is set.* Flag 9 causes the display to blink. When overflow occurs in a running program, execution continues until completion of the program, and then the display blinks.

The blinking can be stopped and flag 9 cleared by pressing $\boxed{\leftarrow}$, $\boxed{\text{ON}}$ or $\boxed{\text{g}} \boxed{\text{CF}} 9$.

Underflow. If the result of a calculation in any register is a number with a magnitude less than $1.000000000 \times 10^{-99}$, that number will be replaced by zero. Underflow does not have any other effect.

* Recall that display does not include the last three digits of the mantissa.

Low-Power Indication

When an asterisk, which indicates low battery power, appears in the lower left-hand side of the display, there is no reason to panic. You still have plenty of time remaining before Continuous Memory is lost, but the batteries should be replaced as soon as possible. The calculator will switch to a slower, low-power mode to conserve battery power at this point. As the remaining power drops, the calculator may turn off on its own during calculations. Refer to Appendix F (page 259) for information on replacing the batteries.



Continuous Memory

Status

The Continuous Memory feature of the HP 15c retains the following in the calculator, even when the display is turned off:

- All numeric data stored in the calculator.
- All programs stored in the calculator.
- Position of the calculator in program memory.
- Display mode and setting.
- Trigonometric mode (Degrees, Radians, or Grads).
- Any pending subroutine returns.
- Flag settings (except flag 9, which clears when the display is *manually* turned off).
- User mode setting.
- Complex mode setting.

When the HP 15c is turned on, it always “wakes up” in Run mode.

If the calculator is turned off, Continuous Memory will be preserved unless the batteries are removed. Refer to Appendix F for instructions on changing batteries.

Resetting Continuous Memory

If at any time you want to reset (entirely clear) the HP 15c Continuous Memory:

1. Turn the calculator off.
2. Press and hold the $\boxed{\text{ON}}$ key, then press and hold the $\boxed{-}$ key.
3. Release the $\boxed{\text{ON}}$ key, then the $\boxed{-}$ key. (This convention is represented as $\boxed{\text{ON}} / \boxed{-}$.)

When Continuous Memory is reset, **Pr Error** (*power error*) will be displayed. Press any key to clear the display.

Note: Continuous Memory can inadvertently be interrupted and reset if the calculator is dropped or otherwise traumatized.

Adjusting the Display Contrast

The display's readability depends on lighting, your viewing angle, and the display contrast setting. To change the display contrast:

1. Press and hold the \boxed{f} key, then press $\boxed{+}$ to darken the display or $\boxed{-}$ to lighten the display.
2. Release the \boxed{f} key, then the $\boxed{+}$ or $\boxed{-}$ key.

Part II
HP 15c
Programming

Section 6

Programming Basics

The next five sections are dedicated to explaining aspects of programming the HP 15c. Each of these programming sections will first discuss basic techniques (The Mechanics), then give examples for the implementation of these techniques (Examples), and lastly discuss finer points of operation in greater detail (Further Information). Read only as far as you need to support your use of the HP 15c.

The Mechanics

Creating a Program

Programming the HP 15c is an easy matter, based simply on recording the keystroke sequence used when calculating manually. (This is called “keystroke programming”.) To create a program out of a series of calculation steps requires two extra manipulations: deciding where and how to enter your data; and loading and storing the program. In addition, programs can be instructed to make decisions and perform iterations through conditional and unconditional branching.

As we step through the fundamentals of programming, we’ll rework the falling object program illustrated in the section The HP 15c: A Problem Solver (page 14).

Loading a Program

Program Mode. Press **g** **P/R** (*program/run*) to set the calculator to *Program mode* (**PRGM** annunciator on). Functions are stored and not executed when keys are pressed in Program mode.

Keystrokes

g **P/R**

Display

000-

Switches to Program mode;
PRGM annunciator and line
number (000) displayed.

Location in Program Memory. Program memory—and therefore the calculator’s position in program memory—is demarcated by line numbers. Line 000 marks the beginning of program memory and cannot be used to store an instruction. The first line that contains an instruction is line 001. Program lines other than 000 do not exist until instructions are written for them.

You *can* start a program at any existent line (designated *nnn*), but it is simplest and safest to start an independent program (as opposed to a subroutine) at the beginning of program memory. As you write, any existing program lines will be preserved and “bumped” down in program memory.

Press **GTO** **CHS** 000 (in Program or Run mode) to move to line 000 without recording the **GTO** statement. *In Run mode*, **f** **CLEAR** **PRGM** will also reset the calculator to line 000—without clearing program memory.

Alternatively, you can clear program memory, which will erase all programs in memory and position you to line 000. To do so, press **f** **CLEAR** **PRGM** *in Program mode*.

Program Begin. A *label* instruction—**f** **LBL** followed by a letter (**A** through **E**) or number (0 through 9 or .0 through .9)—is used to define the beginning of a program or routine. The use of labels allows you to quickly select and run one particular program or routine out of several.

| Keystrokes | Display | |
|-----------------------------------|----------------|---|
| f CLEAR PRGM | 000- | Clears program memory and sets to line 000 (start of program memory). |
| f LBL A | 001-42, 21, 11 | |

Recording a Program. Any key pressed—operator or constant—will be recorded in memory as a programmed instruction.*

* Except the *nonprogrammable functions*, which are listed on page 80.

68 Section 6: Programming Basics

| Keystrokes | Display | |
|--------------------|---------|----|
| 2 | 002- | 2 |
| $\boxed{\times}$ | 003- | 20 |
| 9 | 004- | 9 |
| $\boxed{\cdot}$ | 005- | 48 |
| 8 | 006- | 8 |
| $\boxed{\div}$ | 007- | 10 |
| $\boxed{\sqrt{x}}$ | 008- | 11 |

Given h in the X-register, lines 002 to 008 calculate

$$\sqrt{\frac{2h}{9.8}}$$

Program End. There are three possible endings for a program:

- \boxed{g} \boxed{RTN} (*return*) will end a program, return to line 000, and halt.
- $\boxed{R/S}$ will stop a program *without* moving to line 000.
- The end of program memory contains an automatic \boxed{RTN} .

| Keystrokes | Display | |
|---------------------------|---------|--|
| \boxed{g} \boxed{RTN} | 009- | 43 32 Optional if this is the last program in memory. |

Intermediate Program Stops

Use \boxed{f} \boxed{PSE} (*pause*) as a program instruction to *momentarily* stop a program for approximately one second and display an intermediate result. (Use more than one \boxed{PSE} for a longer pause.)

Use a $\boxed{R/S}$ (*run/stop*) instruction to stop the program indefinitely. The program will remain positioned at that line. You can resume program execution (from that line) by pressing $\boxed{R/S}$ during Run mode, that is, from the keyboard.

Running a Program

Run Mode. Switch back to Run mode when you are done programming: \boxed{g} $\boxed{P/R}$. Program execution must take place in Run mode.

Keystrokes Display

| | | |
|---|-----|--|
| G | P/R | |
|---|-----|--|

Run mode; no **PRGM** annunciator displayed. (The display will depend on any previous result.)

The position in program memory does not change when modes are switched. Should the calculator be shut off, it always “wakes up” in Run mode.

Executing a Program. In Run mode, press f letter label or GSB digit (or letter) label. This addresses a program and starts its execution. The display will flash **running**.

Keystrokes Display

300.51

300 . 51

Key a value for *h* into the X-register.

| | | |
|---|---|--|
| f | A | |
|---|---|--|

7 . 8313

The result of executing program “A”.
(The number of seconds it takes an object dropped from 300.51 meters high to hit the ground.)

Restarting a Program. Press R/S to continue execution of a program that was stopped with a R/S instruction.

User Mode. User mode is an optional condition to save keystrokes when executing *letter-named* programs. Pressing f USER will interchange the f-shifted and primary functions of the A through E keys. You can then execute a program using just one keystroke (skipping the f or GSB).

How to Enter Data

Every program must take into account how and when data will be supplied. This can be done in Run mode before running the program or during an interruption in the program.

1. **Prior entry.** If a variable value will be used in the first line of the program, enter it into the X-register before starting the program. If it will be used later, you can store it (with STO) into a storage register, and recall it (with a programmed RCL) within the program.

70 Section 6: Programming Basics

This is the method used above, where h was placed in the X-register before running the program. No **ENTER** instruction is necessary because program execution (here: **f** **A**) both terminates digit entry and enables the stack lift. The above program then multiplied the contents of the X-register (h) by 2.

The presence of the stack even makes it possible to load more than one variable prior to running a program. Keeping in mind how the stack moves with subsequent calculations and how the stack can be manipulated (as with **X \leftrightarrow Y**), it is possible to write a program to use variables which have been keyed into the X-, Y-, Z-, and T-registers.

2. **Direct entry.** Enter the data as needed as the program runs. Write a **R/S** (*run/stop*) instruction into the program where needed so the program will stop execution. Enter your data, then press **R/S** to restart the program.

Do not key variable data into the program itself. Any values that will vary should be entered anew with each program execution.

Program Memory

At power-up (Continuous Memory reset), the HP 15c offers 546 bytes of program memory and 21 storage registers. *Most* program steps (instructions) use one byte, but some use two. The distribution of memory capacity can be altered, as explained in Appendix C. The maximum attainable program memory is 672 bytes (with the permanent storage registers— R_i , R_0 , and R_1 —remaining); maximum number of storage registers is 99 (with no program memory).

Example

Mother's Kitchen, a canning company, wants to package a ready-to-eat spaghetti mix containing three different cylindrical cans: one of spaghetti sauce, one of grated cheese, and one of meatballs. Mother's needs to calculate the base areas, total surface areas, and volumes of the three different cans. It would also like to know, per package, the total base area, surface area, and volume.



The program to calculate this information uses these formulas and data:

base area = πr^2 .

volume = base area \times height = $\pi r^2 h$.

surface area = 2 base areas + side area = $2\pi r^2 + 2\pi rh$.

| Radius, <i>r</i> | Height, <i>h</i> | Base Area | Volume | Surface Area |
|------------------|------------------|-----------|--------|--------------|
| 2.5 cm | 8.0 cm | ? | ? | ? |
| 4.0 | 10.5 | ? | ? | ? |
| 4.5 | 4.0 | ? | ? | ? |
| TOTALS | | ? | ? | ? |

Method:

1. Enter an *r* value into the calculator and save it for other calculations. Calculate the base area (πr^2), store it for later use, and add the base area to a register which will hold the sum of all base areas.
2. Enter *h* and calculate the volume ($\pi r^2 h$). Add it to a register to hold the sum of all volumes.
3. Recall *r*. Divide the volume by *r* and multiply by 2 to yield the side area. Recall the base area, multiply by 2, and add to the side area to yield the surface areas. Sum the surface areas in a register.

Do *not* enter the actual data while writing the program—just *provide for* their entry. These values will vary and so will be entered before and/or during each program run.

Key in the following program to solve the above problem. The display shows line numbers and keycodes (the row and column location of a key), which will be explained under Further Information.

Keystrokes

Display

000-

Sets calculator to Program mode (**PRGM** displayed).

 CLEAR 

000-

Clears program memory. Starts at line 000.

72 Section 6: Programming Basics

| Keystrokes | Display | |
|-------------------------------|----------------|--|
| f LBL A | 001-42, 21, 11 | Assigns this program the label "A". |
| STO 0 | 002- 44 0 | Stores the contents of X-register into R_0 . r must be in the X-register before running the program. |
| g x² | 003- 43 11 | Squares the contents of the X-register (which will be r). |
| g π | 004- 43 26 | |
| x | 005- 20 | πr^2 , the BASE AREA of a can. |
| STO 4 | 006- 44 4 | Stores the BASE AREA in R_4 . |
| STO + 1 | 007-44, 40, 1 | Keeps a sum of all BASE AREAS in R_1 . |
| R/S | 008- 31 | Stops to display BASE AREA and allow entry of the h value. |
| x | 009- 20 | Multiplies h by the BASE AREA, giving VOLUME. |
| f PSE | 010- 42 31 | Pauses briefly to display VOLUME. |
| STO + 2 | 011-44, 40, 2 | Keeps a sum of all can VOLUMES in R_2 . |
| RCL 0 | 012- 45 0 | Recalls r . |
| ÷ | 013- 10 | Divides VOLUME by r . |
| 2 | 014- 2 | |
| x | 015- 20 | $2\pi rh$, the SIDE AREA of a can. |
| RCL 4 | 016- 45 4 | Recalls the BASE AREA of the can. |
| 2 | 017- 2 | } Multiplies base area by two (for top and bottom). |
| x | 018- 20 | |

| Keystrokes | Display | |
|----------------------------------|-----------------|--|
| $\boxed{+}$ | 019- | 40 SIDE AREA + BASE AREA = SURFACE AREA. |
| $\boxed{\text{STO}} \boxed{+} 3$ | 020-44 , 40 , 3 | Keeps a sum of all SURFACE AREAS in R_3 . |
| $\boxed{g} \boxed{\text{RTN}}$ | 021- 43 32 | Ends the program and returns program memory to line 000. |

Now, let's run the program:

| Keystrokes | Display | |
|--|----------|--|
| $\boxed{g} \boxed{\text{P/R}}$ | | Sets calculator to Run mode. (PRGM cleared.) |
| $\boxed{f} \boxed{\text{CLEAR}} \boxed{\text{REG}}$ | | Clears <i>all</i> storage registers. The display does not change. |
| 2.5 | 2.5 | Enter r of the first can. |
| $\boxed{f} \boxed{A}$ (or: $\boxed{\text{GSB}} \boxed{A}$) | 19.6350 | Starts program A. BASE AREA of first can. (running flashes during execution.) |
| 8 | 8 | Enter h of first can. Then restart program. |
| $\boxed{\text{R/S}}$ | 157.0796 | VOLUME of first can. |
| | 164.9336 | SURFACE AREA of first can. |
| 4 | 4 | Enter r of the second can. |
| $\boxed{\text{R/S}}$ | 50.2655 | BASE AREA of second can. |
| 10.5 | 10.5 | Enter h of second can. |
| $\boxed{\text{R/S}}$ | 527.7876 | VOLUME of second can. |
| | 364.4247 | SURFACE AREA of second can. |
| 4.5 | 4.5 | Enter r of the third can. |
| $\boxed{\text{R/S}}$ | 63.6173 | BASE AREA of third can. |

| Keystrokes | Display | |
|--------------|----------|------------------------------|
| 4 | 4 | Enter <i>h</i> of third can. |
| R/S | 254.4690 | VOLUME of third can. |
| | 240.3318 | SURFACE AREA of third can. |
| RCL 1 | 133.5177 | Sum of BASE AREAS. |
| RCL 2 | 939.3362 | Sum of VOLUMES. |
| RCL 3 | 769.6902 | Sum of SURFACE AREAS. |

The preceding program illustrates the basic techniques of programming. It also shows how data can be manipulated in Program and Run modes by entering, storing, and recalling data (input and output) using **ENTER**, **STO**, **RCL**, storage register arithmetic, and programmed stops.

Further Information

Program Instructions

Each digit, decimal point, and function key is considered an *instruction* and is stored in one *line* of program memory. An instruction may include prefixes (such as **f**, **STO**, **GTO** and **LBL**) and still occupy only one line. Most instructions require one *byte* of program memory; however, some require two. For a complete list of two-byte instructions, refer to Appendix C.

Instruction Coding

Each key on the HP 15c keyboard—except for the digit keys 0 through 9—is identified in Program mode by a two-digit “keycode” that corresponds to the key’s position on the keyboard.

| Instruction | Code | |
|------------------------------|---------------|-------------------------|
| STO + 1 | 006-44, 40, 1 | Sixth program line. |
| f DSE I | xxx-42, 5, 25 | DSE is just “5”. |

The first digit of a keycode refers to the row (1 to 4 from top to bottom), and the second digit refers to the column (1, 2, ... 9, 0 from left to right). Exception: the keycode for a digit key is simply that digit.

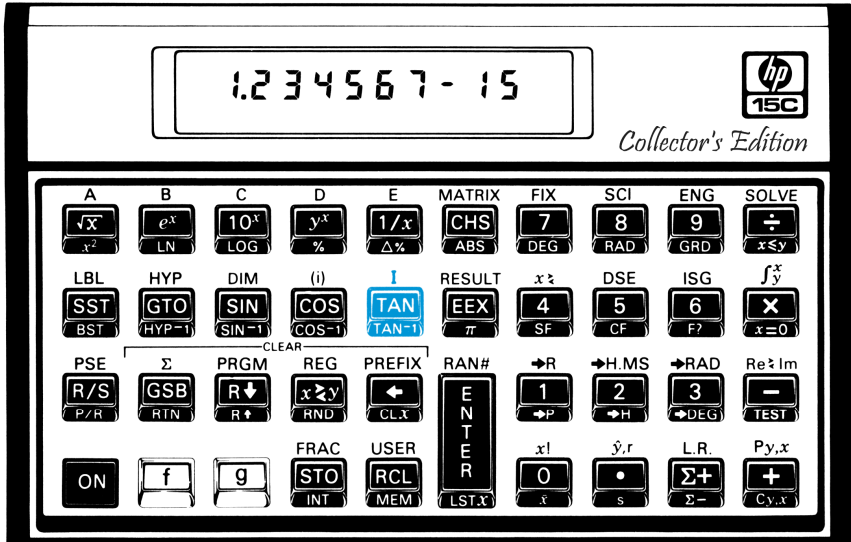

Keycode 25: second row, fifth key.

Memory Configuration

Understanding memory configuration is not essential to your use of the HP 15c. It is essential, however, for obtaining maximum efficiency in memory and programming use. The more you program, the more useful this knowledge will be. Memory configuration and allocation is thoroughly explained in Appendix C, Memory Allocation.

Should you ever get an **Error 10**, you have run up against limitations of the HP 15c memory. If you learn how to reallocate memory, you can greatly increase your ability to store information in the HP 15c.

The HP 15c memory consists of 99 registers (R_0 to R_{97} and the Index register) divided between data storage and programming/advanced function capability. The initial configuration is:

- 78 registers for both programming and the advanced functions (**SOLVE**, \int^x , the imaginary stack, and **MATRIX** functions). At seven bytes of memory per register, this is equal to 546 program bytes if no memory is dedicated to advanced functions.
- 21 registers for data storage (R_0 to R_9 , R_{10} to R_{19} , and the Index register).

Initial Memory Configuration

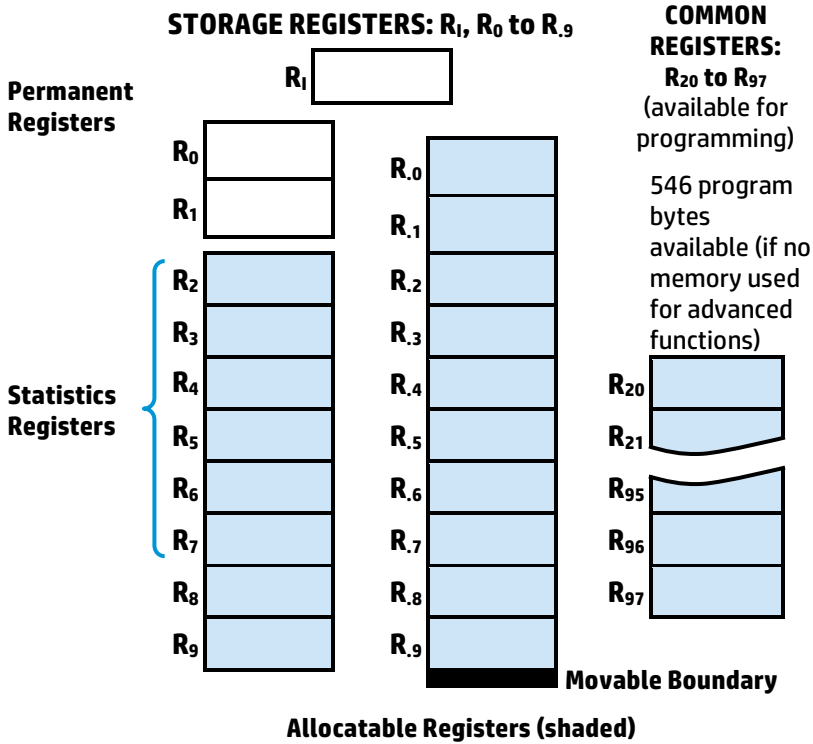

Memory is reallocated by telling the calculator which data storage register shall be the highest data register; all other registers are left for programming and advanced functions.

Keystrokes

60 f DIM (i)*

Display

60 . 0000

R₆₀ and below allocated to data storage; thirty-seven (R₆₁ to R₉₇) remain for programming.

* The optional omission of the f keystroke *after* another prefix key is explained on page 78, Abbreviated Key Sequences.

| Keystrokes | Display | |
|-----------------------------------|-----------|--|
| 1 f DIM (i) | 1 . 0000 | R ₁ and R ₀ allocated for data storage; R ₂ to R ₉₇ available for programming and advanced functions. |
| 19 f DIM (i) | 19 . 0000 | Original allocation: R ₁₉ (R ₉) and below for data storage; R ₂₀ to R ₉₇ for programming and advanced functions.* |
| RCL DIM (i) | 19 . 0000 | Displays the current highest data register. |

The **DIM** and **MEM** (*memory status*) functions are described in detail in Appendix C.

Keep in mind that an error message will result (*given the above memory configuration*) if

1. You try to address a register higher than R₁₉ (R₉), which initially is the highest register allocated to data storage (**Error 3**).
2. You have 546 occupied program bytes and try to load more program lines (**Error 4**).
3. You try to run an advanced function with insufficient available memory (**Error 10**).

Program Boundaries

End. Not every program needs to end with a **RTN** or **R/S** instruction. If you are at the end of occupied program memory, there is an *automatic RTN* instruction, so you do not need to enter one. This can save you one line of memory. On the other hand, a program can “end” by simply transferring execution to another routine using **GTO** (Section 7).

Labels. Labels in a program (or subroutine) are markers telling the calculator where to begin execution. Following an **f label** or **GSB label** instruction, the calculator will search downward in program memory for the corresponding label. If need be, the search will wrap around at the end of program memory and continue at line 000. When it

* For memory allocation and indirect addressing, registers R₀ through R₉ are referred to as R₁₀ through R₁₉.

78 Section 6: Programming Basics

encounters an appropriate label, the search stops and execution begins.

If a label is encountered as part of a running program, it has no effect, that is, execution simply continues. Therefore, you can label a subordinate routine within a program (more on subroutines in Section 9).

Since the calculator searches in only one direction from its present position, it is possible (though not advisable) to use duplicate program labels. Execution will begin at the first appropriately labeled line encountered.

If an **f** **A** entry starts the search for “A” here, 

it then proceeds downward through memory, wraps around to line 000, and stops at label “A”. Execution then starts and continues (ignoring any other labels) until a halt instruction.

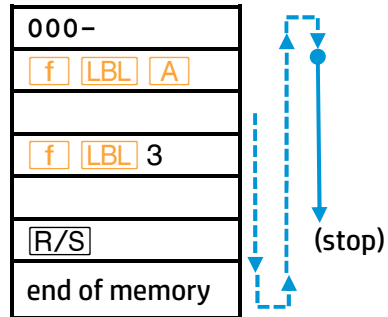

Unexpected Program Stops

Pressing Any Key. Pressing any key will halt program execution. It will *not* halt in the middle of an operation. This instruction will be completed before the program stops.

Error Stops. Program execution is immediately halted when the calculator attempts an improper operation that results in an **Error** display.

To see the line number and keycode of the error-causing instruction (the line at which the program stopped), press any one key to remove the **Error** message, then switch to Program mode.

If the display is flashing when a program stops, an overflow condition exists (page 61). Press **←**, **ON**, or **9** **CF** 9 to stop the blinking.



Abbreviated Key Sequences

In certain cases, an **f** prefix you might expect to include in a key sequence is not needed. The rule for using an *abbreviated key sequence* is: the **f** prefix key is unnecessary after any other prefix key. (Page 19 contains a list of prefix keys.)

For example, $\boxed{f} \boxed{LBL} \boxed{f} \boxed{A}$ becomes $\boxed{f} \boxed{LBL} \boxed{A}$, $\boxed{f} \boxed{DIM} \boxed{f} \boxed{(i)}$ becomes $\boxed{f} \boxed{DIM} \boxed{(i)}$, and $\boxed{STO} \boxed{f} \boxed{RAN\#}$ becomes $\boxed{STO} \boxed{RAN\#}$. The removal of the \boxed{f} is not ambiguous because the \boxed{f} -shifted function is the only logical one in these cases. The keycodes for such instructions do not include the extraneous \boxed{f} even if you do key it in.

User Mode

User mode is a convenience to save keystrokes when addressing (calling up) programs for execution. Pressing $\boxed{f} \boxed{USER}$ will exchange the primary functions and \boxed{f} -shifted functions of the \boxed{A} through \boxed{E} keys only. In User mode (**USER** annunciator displayed):

| | | | | | | |
|-------------------|---|--------------------|---------------|----------------|---------------|---------------|
| \boxed{f} shift |  | A | B | C | D | E |
| Primary |  | $\boxed{\sqrt{x}}$ | $\boxed{e^x}$ | $\boxed{10^x}$ | $\boxed{y^x}$ | $\boxed{1/x}$ |
| \boxed{g} shift |  | x^2 | LN | LOG | % | $\Delta\%$ |

Press $\boxed{f} \boxed{USER}$ again to deactivate User mode.

Polynomial Expressions and Horner's Method

Some expressions, such as polynomials, use the same variable several times for their solution. For example, the expression

$$f(x) = Ax^4 + Bx^3 + Cx^2 + Dx + E$$

uses the variable x four different times. A program to solve such an equation could repeatedly recall a stored copy of x from a storage register. A shorter programming method, however, would be to use a stack which has been filled with the constant (refer to Loading the Stack with a Constant, page 41).

Horner's Method is a useful means of rearranging polynomial expressions to cut calculation steps and calculation time. It is especially expedient in \boxed{SOLVE} and $\boxed{\int y^x}$, two rather long-running functions that use subroutines.

This method involves rewriting a polynomial expression in a nested fashion to eliminate exponents greater than 1:

$$\begin{aligned} & Ax^4 + Bx^3 + Cx^2 + Dx + E \\ & (Ax^3 + Bx^2 + Cx + D)x + E \\ & ((Ax^2 + Bx + C)x + D)x + E \\ & (((Ax + B)x + C)x + D)x + E \end{aligned}$$

80 Section 6: Programming Basics

Example: Write a program for $5x^4 + 2x^3$ as $((5x + 2)x)x$, then evaluate for $x = 7$.

Keystrokes

Display

| | | |
|---|----------------|---|
| g P/R | 000- | Assumes position in memory is line 000. If it is not, clear program memory. |
| f LBL B | 001-42, 21, 12 | |
| 5 | 002- 5 | |
| x | 003- 20 | 5x. |
| 2 | 004- 2 | |
| + | 005- 40 | 5x + 2. |
| x | 006- 20 | (5x + 2)x. |
| x | 007- 20 | (5x + 2)x ² . |
| x | 008- 20 | (5x + 2)x ³ . |
| g RTN | 009- 43 32 | |
| g P/R | | Returns to Run mode. Prior result remains in display. |
| 7 ENTER ENTER ENTER | 7.0000 | Loads the stack (X-, Y-, Z-, and T-registers) with 7. |
| f B | 12,691.0000 | |

Nonprogrammable Functions

When the calculator is in Program mode, almost every function on the keyboard can be recorded as an instruction in program memory. The following functions *cannot* be stored as instructions in program memory.

| | | |
|-------------------------------------|----------------------------------|----------------------|
| f CLEAR PREFIX | g BST | SST |
| f CLEAR PRGM | g MEM | ← |
| f (i) | g P/R | ON / • |
| f USER | GTO CHS <i>nnn</i> | ON / - |

Problems

1. The village of Sonance has installed a 12-o'clock whistle in the firehouse steeple. The sound level at the firehouse door, 3.2 meters from the whistle, is 138 decibels. Write a program to find the sound level at various distances from the whistle.

Use the equation $L = L_0 - 20 \log (r/r_0)$, where:

L_0 is the known sound level (138 dB) at a point near the source,

r_0 is the distance of that point from the source (3.2 m),

L is the unknown sound level at a second point, and

r is the distance of the second point from the source in meters.

What is the sound level at 3 km from the source ($r = 3$ km)?

A possible keystroke sequence is:

\boxed{g} $\boxed{P/R}$ \boxed{f} \boxed{LBL} \boxed{C} 3.2 $\boxed{\div}$ \boxed{g} \boxed{LOG} 20 $\boxed{\times}$ \boxed{CHS} 138 $\boxed{+}$
 \boxed{g} \boxed{RTN} \boxed{g} $\boxed{P/R}$ taking 15 program lines and 15 bytes of memory. This problem can be solved in a more general way by removing the specific values 3.2 and 138 from the program, and instead recalling the L_0 and r_0 values from storage registers; or by removing 3.2 and 138 and loading L_0 , r , and r_0 into the stack before execution: L_0 \boxed{ENTER} r \boxed{ENTER} r_0 .

(Answer: for $r = 3$ km, $L = 78.5606$ dB.)

2. A "typical large" tomato weighs about 200 grams, of which about 188 g (94%) are water. A tomato grower is trying to produce tomatoes of lower percentage water. Write a program to calculate the percent change in water content of a given tomato compared to the typical tomato. Use a programmed stop to enter the water weight of the new tomato.

What is the percent change in water content for a 230 g tomato of which 205 g are water?

A possible keystroke sequence is:

\boxed{f} \boxed{LBL} \boxed{D} .94 \boxed{ENTER} $\boxed{R/S}$ (enter water weight of new tomato) \boxed{ENTER} $\boxed{R/S}$ (enter total weight of new tomato) $\boxed{\div}$ \boxed{g}
 $\boxed{\Delta\%}$ \boxed{g} \boxed{RTN} taking 11 program lines and 11 bytes of memory.

(Answer: for the 230 g tomato above, the percent change in percent water weight is -5.1804% .)

Section 7

Program Editing

There are many reasons to modify a program after you've already stored it: you might want to add or delete an instruction (like `[STO]`, `[PSE]`, or `[R/S]`), or you might even find some errors! The HP 15c is equipped with several editing features to make this process as easy as possible.

The Mechanics

Making a program modification of any kind involves two steps: moving to the proper line (the location of the needed change) and making the deletion(s) and/or insertion(s).

Moving to a Line in Program Memory

The Go To (`[GTO]`) Instruction. The sequence `[GTO] [CHS] nnn` will move program memory to line number *nnn*, whether pressed in Run mode or Program mode (**PRGM** displayed). This is *not* a programmable sequence; it is for *manually* finding a specific position in program memory. The line number must be a three-digit number satisfying $000 \leq nnn \leq 672$.

The Single Step (`[SST]`) Instruction. To move only one line at a time forward through program memory, press `[SST]` (*single step*). This function is not programmable.

In Program mode: `[SST]` will move the memory position forward one line and display that instruction. The instruction is *not* executed. If you hold the key down, the calculator will continuously scroll through the lines in program memory.

In Run mode: `[SST]` will display the current program line while the key is held down. When the key is released, the current instruction is executed, the result displayed, and the calculator steps forward to the next program line to be executed.

The Back Step (BST) Instruction. To move one line *backwards* in program memory, press **BST** (*back step*) in Program or Run mode. This function is not programmable. **BST** will scroll (with the key held down) in Program mode. Program instructions are *not* executed.

Deleting Program Lines

Deletions of program instructions are made with **←** (*back arrow*) in *Program mode*. Move to the line you want to delete, then press **←**. Any remaining following lines will be renumbered to stay in sequence.

Pressing **←** in Run mode does not affect program memory, but is used for display clearing. (Refer to page 21.)

Inserting Program Lines

Additions to a program are made by moving to the line *preceding* the point of insertion. Any instruction you key in will be added *following* the line currently in the display. To alter an instruction, first delete it, then add the new version.

Examples

Let's refer back to the can volume program on page 71 in Section 6 and make a few changes in the instructions. (The can program as listed below is assumed to be in memory starting on line 001.)

Deletions: If we don't need the summed base area, volume, and surface area values, we can delete the storage register additions (lines 007, 011, and 020).

Changes: To eliminate the need to stop the program to enter the height value (h), change the **R/S** instruction to a **RCL** 1 instruction (because of the above deletions, R_1 is no longer being used) and store h in R_1 before running the program. To clean things up, let's also alter **STO** 4 (line 006) to **STO** 2 and **RCL** 4 (old line 016) to **RCL** 2, since we are no longer using R_2 and R_3 .

The editing process is diagrammed on the next page.

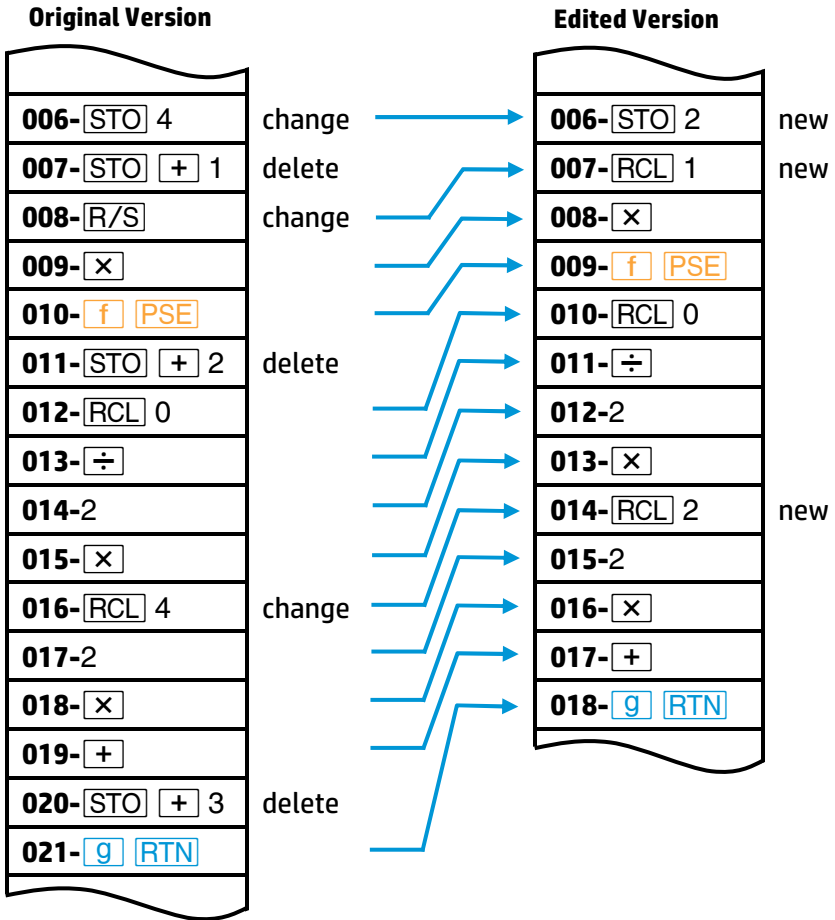

Let's start at the end of the program and work backwards. In this way, deletions will not change the line numbers of the preceding lines in the program.

| Keystrokes | Display | |
|---|---------------|---|
| g P/R | 000- | Program mode. (Assumes position is at line 000.) |
| GTO CHS 020 (or use SST) | 020-44, 40, 3 | Moves position to line 020 (instruction STO + 3.) |
| ← | 019- 40 | Line 020 deleted. |

| Keystrokes | Display | |
|--|---------------|---|
| g BST (hold) | 016- 45 4 | The next line to edit is line 016 (RCL 4). |
| ← | 015- 20 | Line 016 deleted. |
| RCL 2 | 016- 45 2 | Line 016 changed to RCL 2. |
| GTO CHS 011 (or hold BST) | 011-44, 40, 2 | Moves to line 011 (STO + 2). |
| ← | 010- 42 31 | Line 011 deleted. |
| g BST (hold) | 008- 31 | Stop! (Single-stepping backwards to line 008: R/S .) |
| ← | 007-44, 40, 1 | R/S deleted. |
| RCL 1 | 008- 45 1 | Line 008 changed to RCL 1. |
| g BST | 007-44, 40, 1 | Back-step to line 007. |
| ← | 006- 44 4 | Line 007 (STO + 1) deleted. |
| ← | 005- 20 | Line 006 (STO 4) deleted. |
| STO 2 | 006- 44 2 | Changed to STO 2. |

The replacement of a line proceeds like this:

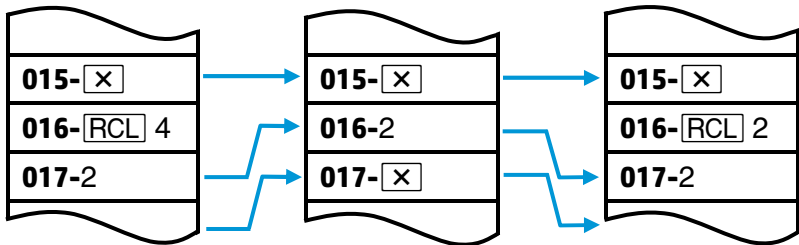

Further Information

Single-Step Operations

Single-Step Program Execution. If you want to check the contents of a program or the location of an instruction, you can single step through the program *in Program mode*. If, on the other hand, running the program produces an error, or you suspect that a portion of the program is faulty, you can check the program by *executing* it stepwise. This is done by pressing **SST** *in Run mode*.

86 Section 7: Program Editing

Keystrokes

Display

| | | |
|---------------------------------|--------------|-----------------------------------|
| \boxed{G} $\boxed{P/R}$ | | Run mode. |
| \boxed{f} CLEAR \boxed{REG} | | Clear storage registers. |
| \boxed{GTO} \boxed{A} | | Move to first line of program A. |
| 8 \boxed{STO} 1 | 8.0000 | Store a can height. |
| 2.5 | 2.5 | Enter a can radius. |
| \boxed{SST} (hold) | 001-42,21,11 | Keycode for line 001 (label). |
| (release) | 2.5000 | Result of executing line 001. |
| \boxed{SST} | 002- 44 0 | \boxed{STO} 0. |
| | 2.5000 | Result. |
| \boxed{SST} | 003- 43 11 | \boxed{G} $\boxed{x^2}$. |
| | 6.2500 | Result. |
| \boxed{SST} | 004- 43 26 | \boxed{G} $\boxed{\pi}$. |
| | 3.1416 | Result. |
| \boxed{SST} | 005- 20 | $\boxed{\times}$. |
| | 19.6350 | Result: the base area of the can. |

Wrapping. \boxed{SST} will not move program position into “unoccupied” program territory. Instead, the calculator will “wrap around” to line 000. (In Run mode, \boxed{SST} will perform any instructions at the end of program memory, such as \boxed{RTN} , \boxed{GTO} or \boxed{GSB} .)

Line Position

Recall that the calculator’s position in program memory does not change when it is shut off or Program/Run modes are changed. Upon returning to Program mode, the calculator line position will be where you left it. (If you executed a program ending with \boxed{RTN} , the position will be at line 000.) Therefore, if the calculator is left on and shuts itself off, you need only turn it on and switch to Program mode (the calculator always “wakes up” in Run mode) to be back where you were.

Insertions and Deletions

After an insertion, the display will show the instruction you just added. After a deletion, the display will show the line prior to the deleted (now nonexistent) one.

If all space available in memory is occupied, the calculator will not accept any program instruction insertions and **Error 4** will be displayed.

Initializing Calculator Status

The contents of storage registers and the status of calculator settings will affect a program if the program uses those registers or depends on a certain status setting. If the current status is incorrect for the program being run, you will get incorrect results. Therefore, it is wise to clear registers and set relevant modes either just prior to running a program or within the program itself. A self-initializing program is more mistake-proof—but it also uses more program lines.

Calculator-initializing functions are: \boxed{f} CLEAR $\boxed{\Sigma}$, \boxed{f} CLEAR $\boxed{\text{PRGM}}$, \boxed{f} CLEAR $\boxed{\text{REG}}$, \boxed{g} $\boxed{\text{DEG}}$, \boxed{g} $\boxed{\text{RAD}}$, \boxed{g} $\boxed{\text{GRD}}$, \boxed{g} $\boxed{\text{SF}}$, and \boxed{g} $\boxed{\text{CF}}$.

Problems

It is good programming technique to avoid using identical program labels. (This shouldn't be hard, since the HP 15c provides 25 different labels.) To ensure against duplication of labels, you can clear program memory first.

1. The following program is used by the manager of a savings and loan company to compute the future values of savings accounts according to the formula $FV = PV(1 + i)^n$, where FV is future value, PV is present value, i is the periodic interest rate, and n is the number of periods. Enter PV first (into the Y-register) and n second (into the X-register) before executing the program. Given is an annual interest rate of 7.5% (so $i = 0.075$).

88 Section 7: Program Editing

| Keystrokes | Display |
|---|-------------------------|
| \boxed{f} \boxed{LBL} $\boxed{\bullet}$ 1 | 001-42, 21, .1 |
| \boxed{f} \boxed{FIX} 2 | 002-42, 7, 2 |
| 1 | 003- 1 |
| $\boxed{\bullet}$ | 004- 48 |
| 0 | 005- 0 |
| 7 | 006- 7 |
| 5 | 007- 5 |
| $\boxed{X\leftrightarrow Y}$ | 008- 34 |
| $\boxed{y^x}$ | 009- 14 $(1 + i)^n$. |
| \boxed{X} | 010- 20 $PV(1 + i)^n$. |
| \boxed{g} \boxed{RTN} | 011- 43 32 |

} Interest.

Load the program and find the future value of \$1,000 invested for 5 years; of \$2,300 invested for 4 years. Remember to use \boxed{GSB} to run a program with a digit label. (Answers: \$1,435.63; \$3,071.58.)

Alter the program to make the annual interest rate 8.0%.

Using the edited program, find the future value of \$500 invested for 4 years; of \$2,000 invested for 10 years. (Answers: \$680.24; \$4,317.85.)

2. Create a program to calculate the length of a chord ℓ subtended by an angle θ (in degrees) on a circle of radius r , according to the equation

$$\ell = 2r \sin \frac{\theta}{2}.$$

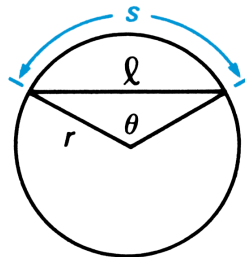

Find ℓ when $\theta = 30^\circ$ and $r = 25$.

(Answer: 12.9410. A possible sequence is: \boxed{f} \boxed{LBL} \boxed{A} \boxed{g} \boxed{DEG} \boxed{f} \boxed{FIX} 4 2 \boxed{X} $\boxed{X\leftrightarrow Y}$ 2 $\boxed{\div}$ \boxed{SIN} \boxed{X} \boxed{g} \boxed{RTN}). (Assumes θ in Y-register and r in X-register when program is run.)

Make any necessary modifications in the program to also find and display s , the length of the circular arc cut by θ (*in radians*), according to the equation

$$s = r\theta.$$

Complete the following table:

| θ | r | ℓ | s |
|----------|-----|--------|-----|
| 45° | 50 | ? | ? |
| 90° | 100 | ? | ? |
| 270° | 100 | ? | ? |

Answers: 38.2683 and 39.2699; 141.4214 and 157.0796; 141.4214 and 471.2389. A possible new program is:

| Keystrokes | Display | |
|---|----------------|---------------------------------------|
| g P/R | 000- | Program mode. |
| f LBL A | 001-42, 21, 11 | Assigns program label "A". |
| g DEG | 002- 43 7 | |
| f FIX 4 | 003-42, 7, 4 | |
| STO 0 | 004- 44 0 | Stores r into R_0 . |
| 2 | 005- 2 | } Multiplies radius by 2. |
| x | 006- 20 | |
| x\rightarrowy | 007- 34 | Brings θ to X-register. |
| STO 1 | 008- 44 1 | Stores θ into R_1 . |
| 2 | 009- 2 | } Divides θ by 2. |
| ÷ | 010- 10 | |
| SIN | 011- 23 | } $\ell = 2r \sin \frac{\theta}{2}$. |
| x | 012- 20 | |
| f PSE | 013- 42 31 | Pause briefly to display ℓ . |
| f PSE | 014- 42 31 | Pause a bit longer. |
| RCL 0 | 015- 45 0 | Recalls r . |
| RCL 1 | 016- 45 1 | Recalls θ . |
| f \rightarrowRAD | 017- 42 3 | Converts degrees to radians. |
| x | 018- 20 | $s = r\theta$. |
| g RTN | 019- 43 32 | |

Section 8

Program Branching and Controls

Although the instructions in a program are normally executed sequentially, it is often desirable to transfer execution to a part of the program *other than* the next line. *Branching* in the HP 15c may be *simple*, or it may depend on a certain *condition*. By branching to a previous line, it is possible to execute part of a program more than once—a process called *looping*.

The Mechanics

Branching

The Go To (GTO) Instruction. Simple branching—that is, unconditional branching—is carried out with the instruction GTO *label*. In a running program, GTO will transfer execution to the next appropriately labeled program or routine (*not* to a line *number*).

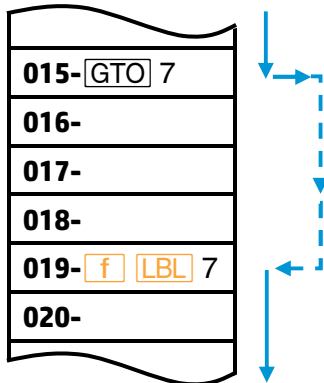

The calculator searches forward in memory, wrapping around through line 000 if necessary, and resumes execution at the first line containing the proper label.

Looping. If a GTO instruction specifies a label at a lower-numbered line

(that is, a prior line), the series of instructions between the `GTO` and the label will be executed repeatedly—possibly indefinitely. The continuation of this loop can be controlled by a conditional branch, an `R/S` instruction (written into the loop), or simply by pressing any key during execution (which stops the program).

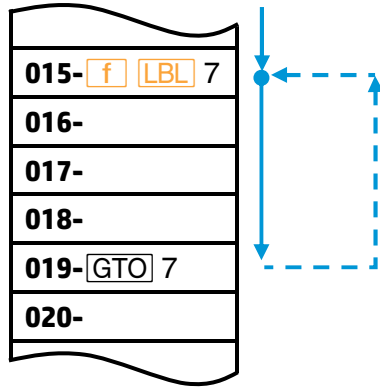

Conditional Tests

Another way to alter the sequence of program execution is by a *conditional test*, a true/false test which compares the number in the X-register either to zero or to the number in the Y-register. The HP 15c provides 12 different tests, two explicit on the keyboard and 10 others accessible using `g TEST n`.*

1. Direct: `g x≤y` and `g x=0`.
2. Indirect: `g TEST n`.

| <i>n</i> | Test | <i>n</i> | Test |
|----------|------------|----------|------------|
| 0 | $x \neq 0$ | 5 | $x = y$ |
| 1 | $x > 0$ | 6 | $x \neq y$ |
| 2 | $x < 0$ | 7 | $x > y$ |
| 3 | $x \geq 0$ | 8 | $x < y$ |
| 4 | $x \leq 0$ | 9 | $x \geq y$ |

* Four of the conditional tests can also be used for complex values, as explained in Section 11 on page 132.

92 Section 8: Program Branching and Controls

Following a conditional test, program execution follows the “Do if True” Rule: it proceeds sequentially if the condition is true, and it *skips one instruction if the condition is false*. A `GTO` instruction is often placed right after a conditional test, making it a *conditional branch*; that is, the `GTO` branch is executed only if the test condition is met.

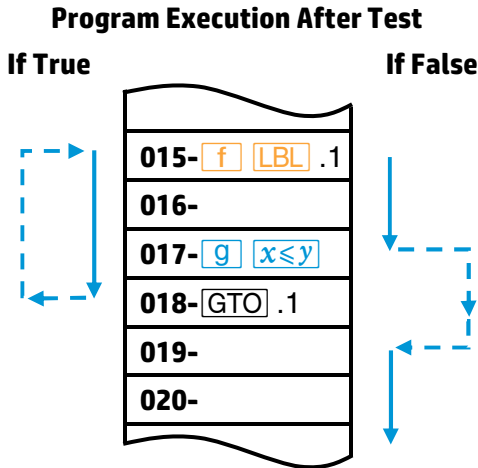

Flags

Another conditional test for programming is a *flag* test. A flag is a status indicator that is either *set* (= true) or *clear* (= false). Again, execution follows the “Do if True” Rule: it proceeds sequentially if the flag is set, and skips one line if the flag is clear.

The HP 15c has eight *user* flags, numbered 0 to 7, and two *system* flags, numbered 8 (Complex mode) and 9 (overflow condition). The system flags are discussed later in this section. All flags can be set, cleared, and tested as follows:

- `g` `SF` `n` will set flag number `n` (0 to 9).
- `g` `CF` `n` will clear flag number `n`.
- `g` `F?` `n` will check if flag `n` is set.

A flag `n` that has been set remains set until it is cleared either by a `CF` `n` instruction or by clearing (resetting) Continuous Memory.

Examples

Example: Branching and Looping

A radiobiology lab wants to predict the diminishing radioactivity of a test amount of ^{131}I , a radioisotope. Write a program to figure the radioactivity at 3-day intervals until a given limit is reached. The formula for N_t , the amount of radioisotope remaining after t days, is

$$N_t = N_0(2^{-t/k}),$$

where $k = 8$ days, the half-life of ^{131}I , and N_0 is the initial amount.

The following program uses a loop to calculate the number of millicuries (mCi) of isotope theoretically remaining at 3-day intervals of decay. Included is a conditional test to check the result and end the program when radioactivity has fallen to a given value (a limit).

The program assumes t_1 —the first day of measurement—is stored in R_0 , N_0 —the initial amount of isotope—is stored in R_1 , and the limit value for radioactivity is stored in R_2 .



Keystrokes

Display

G **P/R**

000-

Program mode.

f **CLEAR** **PRGM**

000-

(Optional.)

f **LBL** **A**

001-42 , 21 , 11

Each loop returns to this line.

RCL 0

002- 45 0

Recalls current t which changes with each loop.

f **PSE**

003- 42 31

Pauses to display t .

8

004- 8

k .

÷

005- 10

CHS

006- 16

$-t/k$.

2

007- 2

x \rightrightarrows y

008- 34

y x

009- 14

$2^{-t/k}$.

94 Section 8: Program Branching and Controls

| Keystrokes | Display | |
|--|--------------|---|
| RCL X 1 | 010-45,20, 1 | Recall multiplication with the contents of R ₁ (N ₀), yielding N _t , the mCi of ¹³¹ I remaining after <i>t</i> days. |
| f PSE | 011- 42 31 | Pauses to display N _t . |
| RCL 2 | 012- 45 2 | Recalls limit value to X-register. |
| g TEST 9 | 013-43,30, 9 | <i>x</i> ≥ <i>y</i> ? Tests whether limit value (in X) meets or exceeds N _t (in Y). |
| g RTN | 014- 43 32 | If so, program ends. |
| 3 | 015- 3 | If not, program continues. |
| STO + 0 | 016-44,40, 0 | Adds 3 days to <i>t</i> in R ₀ . |
| GTO A | 017- 22 11 | Go to “A” and repeat execution to find a new N _t from a new <i>t</i> . |

Notice that without lines 012 to 014, the loop would run indefinitely (until stopped from the keyboard).

Let’s run the program, using *t*₁ = 2 days, N₀ = 100 mCi, and a limit value of half of N₀ (50 mCi).

| Keystrokes | Display | |
|---|----------|-------------------------------------|
| g P/R | | Run mode (display will vary). |
| 2 STO 0 | 2.0000 | <i>t</i> ₁ . |
| 100 STO 1 | 100.0000 | N ₀ . |
| 50 STO 2 | 50.0000 | Limit value for N _t . |
| f A | 2.0000 | <i>t</i> ₁ . |
| | 84.0896 | N ₁ . |
| | 5.0000 | <i>t</i> ₂ . |
| | 64.8420 | N ₂ . |
| | 8.0000 | <i>t</i> ₃ . |
| | 50.0000 | N ₃ . |
| | 50.0000 | N _t limit; program ends. |

Example: Flags

Calculations on debts or investments can be calculated in two ways: for payments made in advance (at the beginning of a given period) and for payments made in arrears (at the end of a given period). If you write a program to calculate the value (or “present value”) of a debt or investment with periodic interest and periodic payments, you can use a flag as a status indicator to tell the program whether to assume payments are made in advance or payments are made in arrears.

Suppose you are planning the payment of your child’s future college tuition. You expect the cost to be about \$3,000/year or about \$250/month. If you wanted to withdraw the monthly payments from a bank account yielding 6% per year, compounded monthly (which equals 0.5% per month), how much must you deposit in the account at the start of the college years to fund monthly payments for the next 4 years?

The formula is

$$V = P \left[\frac{1 - (1 + i)^{-n}}{i} \right] (1 + i) \quad \text{if payments are to be made each month in advance,}$$

and the formula is

$$V = P \left[\frac{1 - (1 + i)^{-n}}{i} \right] \quad \text{if payments are to be made each month in arrears.}$$

V is the total value of the deposit you must make in the account;

P is the size of the *periodic* payment you will draw from the account;

i is the *periodic* interest rate (here: “periodic” means monthly, since interest is compounded monthly); and

n is the number of compounding periods (months).

The following program allows for either payment mode. It assumes that, before the program is run, P is in the Z-register, n is in the Y-register, and i is in the X-register.

96 Section 8: Program Branching and Controls

| Keystrokes | Display | |
|------------------------------|----------------|--|
| g P/R | 000- | Program mode. |
| f LBL B | 001-42, 21, 12 | Start at "B" if payments to be made at the beginning. |
| g CF 0 | 002-43, 5, 0 | Flag 0 clear (false); indicates advance payments. |
| GTO 1 | 003- 22 1 | Go to main routine. |
| f LBL E | 004-42, 21, 15 | Start at "E" if payments to be made at the end. |
| g SF 0 | 005-43, 4, 0 | Flag 0 set (true); indicates payment in arrears. |
| f LBL 1 | 006-42, 21, 1 | Routine 1 (main routine). |
| STO 1 | 007- 44 1 | Stores i (from X-register). |
| 1 | 008- 1 | |
| + | 009- 40 | $(1+i)$. |
| X↔Y | 010- 34 | Puts n in X; $(1+i)$ in Y. |
| CHS | 011- 16 | $-n$. |
| y^x | 012- 14 | $(1+i)^{-n}$. |
| CHS | 013- 16 | $-(1+i)^{-n}$. |
| 1 | 014- 1 | |
| + | 015- 40 | $1 - (1+i)^{-n}$. |
| RCL ÷ 1 | 016-45, 10, 1 | Recall division with R_1 (i) to get $[1 - (1+i)^{-n}]/i$. |
| x | 017- 20 | Multiplies quantity by P . |
| g F? 0 | 018-43, 6, 0 | Flag 0 set? |
| g RTN | 019- 43 32 | End of calculation if flag 0 set (for payments in arrears). |
| RCL 1 | 020- 45 1 | Recalls i . |
| 1 | 021- 1 | |
| + | 022- 40 | $(1+i)$. |
| x | 023- 20 | Multiplies quantity by final term. |
| g RTN | 024- 43 32 | End of calculation if flag 0 clear. |

Now run the program to find the total amount needed in an account from which you want to take \$250/month for 48 months. Enter the periodic interest rate as a decimal fraction, that is, 0.005 per month. First find the sum needed if payments will be made at the beginning of the month (payments in advance), then calculate the sum needed if payments will be made at the end of the month (in arrears).

| Keystrokes | Display | |
|-------------------------|-----------------|---|
| g P/R | | Set to Run mode. |
| 250 ENTER | 250 . 0000 | Monthly payment. |
| 48 ENTER | 48 . 0000 | Payment periods (4 years × 12 months). |
| .005 | 0 . 005 | Monthly interest rate as a decimal fraction. |
| f B | 10 , 698 . 3049 | Deposit necessary for payments to be made in advance. |
| (Repeat stack entries.) | | |
| f E | 10 , 645 . 0795 | Deposit necessary for payment to be made in arrears. (The difference between this deposit and the tuition cost (\$12,000) represents interest earned on the deposit!) |

Further Information

Go To

In contrast to the nonprogrammable sequence **GTO** **CHS** *nnn*, the programmable sequence **GTO** *label* cannot be used to branch to a line *number*, but only to *program label* (a line containing **f** **LBL** *label*).* Execution continues from the point of the new label, and does not return to the original routine unless given another **GTO** instruction.

GTO *label* can also be used in Run mode (that is, from the keyboard) to move to a labeled position in program memory. No execution occurs.

* It is possible to branch under program control to a particular line *number* by using indirect addressing, discussed in Section 10.

Looping

Looping is an application of branching which uses a `GTO` instruction to repeat a portion of the program. A loop can continue indefinitely, or may be conditional. A loop is frequently used to repeat a calculation with different variables. At the same time, a counter, which increments with each loop, may be included to keep track of loop iterations. This counter can then be checked with a conditional test to determine when to exit the loop. (This is shown in the example on page 112.)

Conditional Branching

There are two general applications for conditional branching. One is to control loops, as explained above. A conditional test can check for either a certain calculated value or a certain loop count.

The other major use is to test for options and pursue one. For example, if a salesperson made a variable commission depending on the amount of sale, you could write a program which takes the amount of sale, compares it to a test value, and then calculates a specific commission depending on whether the sale is less than or greater than the test value.

Tests. A conditional test takes what is in the X-register (“x”) and compares it either to zero (such as `x=0`) or to “y”, that is, what is in the Y-register (such as `x≤y`). For an x:y comparison, therefore, you must have the x- and y-values juxtaposed in the X- and Y-registers. This might require that you store a test value and then recall it (bringing it into the X-register). Or, the value might be in the stack and be moved, as necessary, using `x↔y`, `R↓`, or `R↑`.

Tests With Complex Numbers and Matrix Descriptors. Four of the conditional tests also work with complex numbers and matrix descriptors: `x=0`, `TEST 0` ($x \neq 0$), `TEST 5` ($x = y$), and `TEST 6` ($x \neq y$). Refer to Sections 11 and 12 for more information.

Flags

As a conditional test can be used to pick an option by comparing two numbers in a program, a flag can be used to pick an option externally. Usually, a flag is set or cleared first thing in a program by choosing a different starting point (using different labels) depending on the condition or mode you want (refer to the example on page 95).

In this way, a program can accommodate two different modes of input, such as degrees and radians, and make the correct calculation for the mode chosen. You set a flag if a conversion needs to be made, for instance, and clear it if no conversion is needed.

Suppose you had an equation requiring temperature input in Kelvin, although sometimes your data might be in degrees Celsius. You could use a program with a flag to allow either a Kelvin or Celsius input. In part, such a program might include:

| Keystrokes | Display | |
|---|----------------|---|
| g P/R | 000- | Program mode. |
| f LBL C | 001-42, 21, 13 | Start program at "C" for degrees Celsius. |
| g CF 7 | 002-43, 5, 7 | Flag 7 cleared (=false). |
| GTO 1 | 003- 22 1 | |
| f LBL D | 004-42, 21, 14 | Start program at "D" for Kelvin. |
| g SF 7 | 005-43, 4, 7 | Flag 7 set (=true). |
| f LBL 1 | 006-42, 21, 1 | (Assuming temperature in X-register.) |
| g F? 7 | 007-43, 6, 7 | Checks for flag 7 (checks for Celsius or Kelvin input). |
| GTO 2 | 008- 22 2 | If set (Kelvin input), goes to a later routine, skipping the next few instructions. |
| 2 | 009- | 2 If cleared (Celsius input), adds 273 to |
| 7 | 010- | 7 the value in the X-register, since |
| 3 | 011- | 3 $K = ^\circ C + 273$. |
| + | 012- 40 | |
| f LBL 2 | 013-42, 21, 2 | Calculation continues for both modes. |
| ⋮ | | |

The System Flags: Flags 8 and 9

Flag 8. Setting flag 8 will activate Complex mode (described in Section 11), turning on the **C** annunciator. If another method is used to activate Complex mode, flag 8 will automatically be set. Complex mode is deactivated only by clearing flag 8; flag 8 is cleared in the same manner as the other flags.

100 Section 8: Program Branching and Controls

Flag 9. An overflow condition (described on page 61) automatically sets flag 9. Flag 9 causes the display to blink or, if a program is running, waits until execution is complete and then starts blinking the display.

Flag 9 may be cleared in three ways:

- Press **g** **CF** 9 (the common procedure for clearing flags).
- Press **←**. This will only clear flag 9 and stop the blinking—it will not clear the display.
- Turn the calculator off. (Flag 9 is not cleared if the calculator turns itself off.)

If you set flag 9 manually (**SF** 9), it causes the display to blink irrespective of the overflow status of the calculator. As usual, a program will run to completion before the display starts blinking. Therefore, flag 9 can be used as a programming tool to provide a visual signal for a selected condition.

Section 9

Subroutines

When the same set of instructions needs to be used at more than one point in a program, memory space can be conserved by storing those instructions as a single subroutine.

The Mechanics

Go To Subroutine and Return

The `GSB` (*go to subroutine*) instruction is executed in the same way as the `GTO` branch, with one major difference: it establishes a *pending return* condition. `GSB label`, like `GTO label`,* transfers program execution to the line with the corresponding label (`A` to `E`, 0 to 9, or `.0` to `.9`). However, execution then continues *until the first subsequent RTN instruction is encountered*—at which point execution *transfers back* to the instruction immediately following the last `GSB` instruction, and continues on from there.

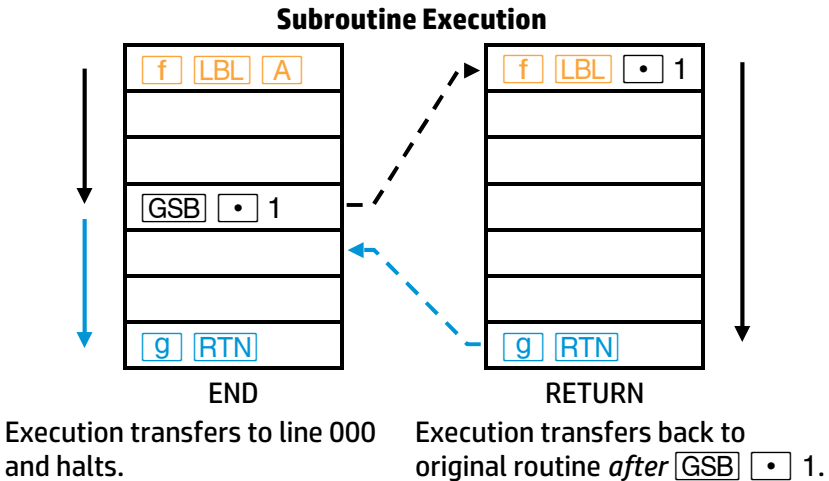

* A `GSB` or `GTO` instruction followed by a *letter* label is an abbreviated key sequence (no `f` necessary). Abbreviated key sequences are explained on page 78.

Subroutine Limits

A subroutine can call up another subroutine, and that subroutine can call up yet another subroutine. This “subroutine nesting”—the execution of a subroutine within a subroutine—is limited to stack of subroutines seven levels deep (this does not count the main program level). The operation of nested subroutines is as shown below:

Main Program

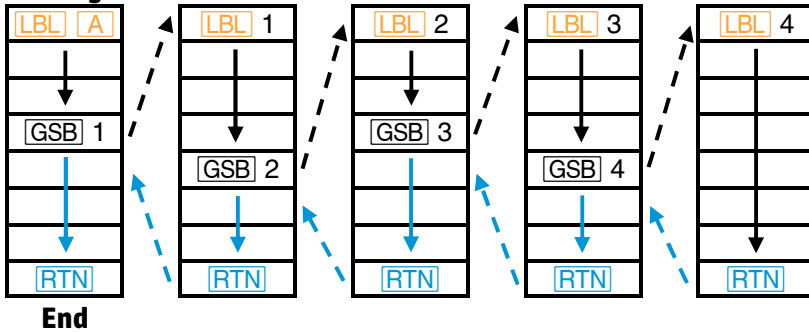

Examples

Example: Write a program to calculate the slope of the secant line joining points (x_1, y_1) and (x_2, y_2) on the graph shown, where $y = x^2 - \sin x$ (given x in radians).

The secant slope is:

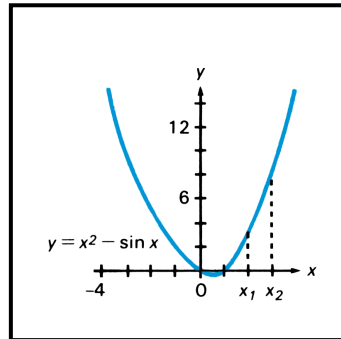

$$\frac{y_2 - y_1}{x_2 - x_1}, \text{ or } \frac{(x_2^2 - \sin x_2) - (x_1^2 - \sin x_1)}{x_2 - x_1}$$

The solution requires that the equation for y be evaluated twice—once for y_1 and once for y_2 , given the data input for x_1 and x_2 . Since the same calculation must be made for different values, it will save program space to call a subroutine to calculate y .

The following program assumes that x_1 has been entered into the Y-register and x_2 into the X-register.

MAIN PROGRAM

```

g P/R
f CLEAR PRGM
000-
001- f LBL 9
002- g RAD
003- STO 0
004- x↔y
005- STO - 0
006- GSB .3

```

(Not programmable.)

Start main program.
 Radians mode.
 Stores x_2 in R_0 .
 Brings x_1 into X; x_2 into Y.
 ($x_2 - x_1$) in R_0 .
 Transfer to subroutine “.3” with x_1 .

Return from subroutine “.3”.

```

007- CHS
008- x↔y
009- GSB .3

```

$-y_1$.
 Brings x_2 into X-register.
 Transfer to subroutine with x_2 .

Return from subroutine “.3”.

```

010- +
011- RCL ÷ 0
012- g RTN

```

$y_2 - y_1$.
 Recalls $(x_2 - x_1)$ from R_0 and
 calculates $(y_2 - y_1)/(x_2 - x_1)$.
 Program end (return to line 000).

SUBROUTINE

```

013- f LBL .3
014- g x²
015- g LSTx
016- SIN
017- -
018- g RTN

```

Start subroutine .3.
 x^2 .
 Recall x .
 Calculates $\sin x$.
 $x^2 - \sin x$, which equals y .
 Return to origin in main program.

Calculate the slope for the following values of x_1 and x_2 : 0.52, 1.25; -1, 1; 0.81, 0.98. Remember to use **GSB** 9 (rather than **f** 9) when addressing a routine with a digit label.

Answers: 1.1507; -0.8415; 1.1652.

104 Section 9: Subroutines

Example: Nesting. The following subroutine, labeled “.4”, calculates the value of the expression $\sqrt{x^2 + y^2 + z^2 + t^2}$ as part of a larger calculation in a larger program. The subroutine calls upon *another* subroutine (a nested subroutine), labeled “.5”, to do the repetitive squaring.

The program is executed after placing the variables *t*, *z*, *y*, and *x* into the T-, Z-, Y-, and X-registers.

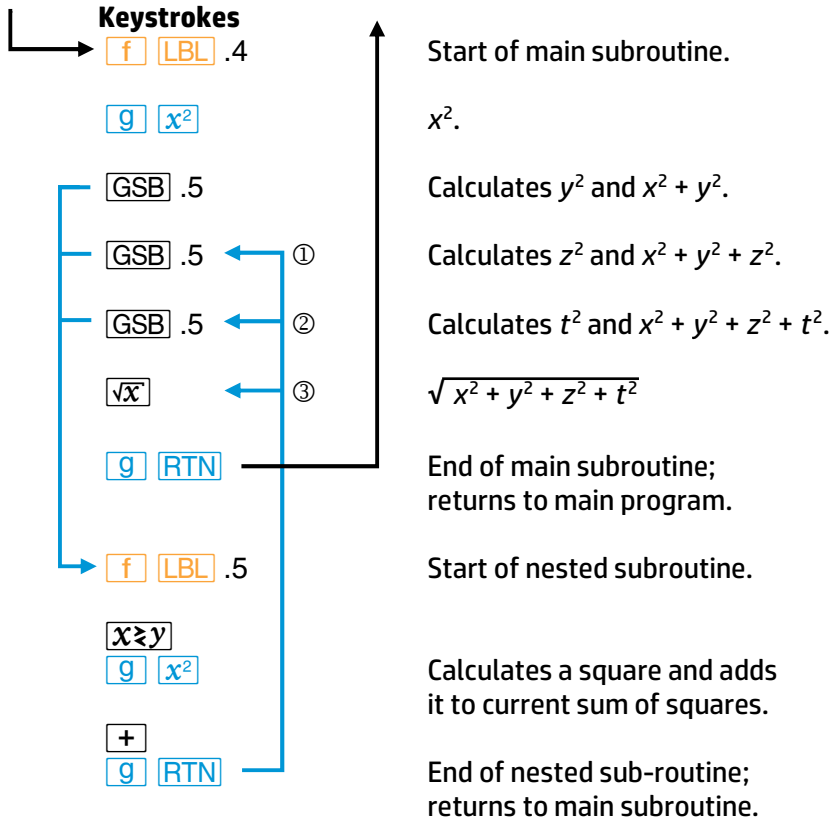

If you run the subroutine (with its nested subroutine) alone using $x = 4.3$, $y = 7.9$, $z = 1.3$, and $t = 8.0$, the answer you get upon pressing **GSB** .4 is 12.1074.

Further Information

The Subroutine Return

The *pending return* condition means that the `RTN` instruction occurring subsequent to a `GSB` instruction causes a return to the line following the `GSB` rather than a return to line 000. This is what makes a subroutine useful and reusable in different parts of a program: it will always return execution to where it branched from, even as that point changes. The only difference between using a `GSB` branch and a `GTO` branch is the transfer of execution *after* a `RTN`.

Nested Subroutines

If you attempt to call a subroutine that is nested more than seven levels deep, the calculator will halt and display **Error 5** when it encounters the `GSB` instruction at the eighth level.

Note that there is no limitation (other than memory size) on the number of nonnested subroutines or *sets* of nested subroutines that you may use.

Section 10

The Index Register and Loop Control

The Index register (R_i) is a powerful tool in advanced programming of the HP 15c. In addition to storage and recall of data the Index register can use an index number to:

- Count and control loops.
- Indirectly address storage registers, including those beyond R_{19} .
- Indirectly branch to program line *numbers*, as well as to labels.
- Indirectly control the display format.
- Indirectly control flag operations.

The **I** and **(i)** Keys

Direct Versus Indirect Data Storage With the Index Register

The Index register is a data storage register that can be used directly, with **I**, or indirectly, with **(i)**.^{*} The difference is important to note:

I

The **I** function uses the *number itself* in the Index register.

(i)

The **(i)** function uses the absolute value of the integer portion of the number in the Index register to address another data storage register. This is called *indirect addressing*.

^{*} Note that the matrix functions and complex functions use the **I** and **(i)** keys also, but for different purposes. Refer to Sections 11 and 12 for their usage.

Indirect Program Control With the Index Register

The **I** key is used for all forms of indirect program control *other than* indirect register addressing. Hence, **I** (not **(i)**) is used for indirect program branching, indirect display format control, and indirect flag control.

Program Loop Control

Program loop counting and control can be carried out in the HP 15c *by any storage register*: R₀ through R₉, R₀ through R₉, or the Index register (**I**). Loop control can also be carried out *indirectly* with **(i)**.

The Mechanics

Both **I** and **(i)** can be used in abbreviated key sequences, omitting the preceding **f** prefix (as explained on page 78).

Index Register Storage and Recall

Direct. **[STO]** **I** and **[RCL]** **I**. Storage and recall between the X-register and the Index register operate in the same manner as with other data storage registers (page 42).

Indirect. **[STO]** (or **[RCL]**) **(i)** stores into (or recalls from) the data storage register whose number is addressed by the integer portion of the value (0 to 97) in the Index register. See the table below and on the next page.

Indirect Addressing

| If R _i contains: | (i) will address: | [GTO] I or [GSB] I will transfer to*: |
|-----------------------------|--------------------------|--|
| ± 0 | R ₀ | f [LBL] 0 |
| ⋮ | ⋮ | ⋮ |
| 9 | R ₉ | f [LBL] 9 |
| 10 | R ₀ | f [LBL] .0 |
| 11 | R ₁ | f [LBL] .1 |
| ⋮ | ⋮ | ⋮ |
| 19 | R ₉ | f [LBL] .9 |
| 20 | R ₂₀ | f [LBL] [A] |

* For R_i ≥ 0 only.

(Continued on next page.)

Indirect Addressing

| If R _i contains: | (i) will address: | GTO I or GSB I will transfer to:* |
|-----------------------------|-------------------|-----------------------------------|
| 21 | R ₂₁ | f LBL B |
| 22 | R ₂₂ | f LBL C |
| 23 | R ₂₃ | f LBL D |
| 24 | R ₂₄ | f LBL E |
| ⋮ | ⋮ | — |
| 97 | R ₉₇ | — |

* For R_i ≥ 0 only.

Index Register Arithmetic

Direct. STO or RCL {+, −, ×, ÷} I. Storage or recall arithmetic operates with the Index register in the same manner as upon other data storage registers (page 43).

Indirect. STO or RCL {+, −, ×, ÷} (i) carries out storage or recall arithmetic with the contents of the data storage register addressed by the integer portion of the number (0 to 97) in the Index register. See the above table.

Exchanging the X-Register

Direct. f XZ I exchanges contents between the X-register and the Index register. (Works the same as XZ n does with registers 0 through .9.)

Indirect. f XZ (i) exchanges contents between the X-register and the data storage register addressed by the number (0 to 97) in the Index register. See the above table.

Indirect Branching With I

The I key—but not the (i) key—can be used for indirect branching (GTO I) and subroutine calls (GSB I). (Only the integer portion of the number in R_i is used.) (i) is only used for indirect addressing of storage registers.)

To Labels. If the R_i value is *positive*, `GTO I` and `GSB I` will transfer execution to the *label* which corresponds to the number in the Index register (see the above table).

For instance, if the Index register contains 20.00500, then a `GTO I` instruction will transfer program execution to `f LBL A`. See the chart on page 107.

To Line numbers. If the R_i value is *negative*, `GTO I` causes branching to that *line number* (using the absolute value of the integer portion of the value in R_i).

For instance, if R_i contains -20.00500, then a `GTO I` instruction will transfer program execution to program line 020.

Indirect Flag Control With I

`SF I`, `CF I`, or `F? I` will set, clear, or test the flag (0 to 9) specified in R_i (by the magnitude of the integer portion).

Indirect Display Format Control With I

`f FIX I`, `f SCI I`, and `f ENG I` will format the display in their customary manner (refer to pages 58–59), using the number in R_i (integer part only) for n , which must be from 0 to 9.*

Loop Control With Counters: ISG and DSE

The `ISG` (*increment and skip if greater than*) and `DSE` (*decrement and skip if less than or equal to*) functions control loop execution by referencing and altering a *loop control number* in a given register. Program execution (skipping a line or not) then depends on that number.

The key sequence is `f {ISG, DSE} register number`. This number is 0 to 9, .0 to .9, `I`, or `(i)`.

The Loop Control Number. The format of the loop control number is:

| | |
|----------------------------------|--|
| <code>±nnnnn</code> | is the current counter value, |
| <code>nnnnn.xxxyy</code> , where | <code>xxx</code> is the test (goal) value, and |
| | <code>yy</code> is the increment or decrement value. |

* Except when using `I?` (Section 14)

110 Section 10: The Index Register and Loop Control

For example, the number 0.05002 in a storage register represents:

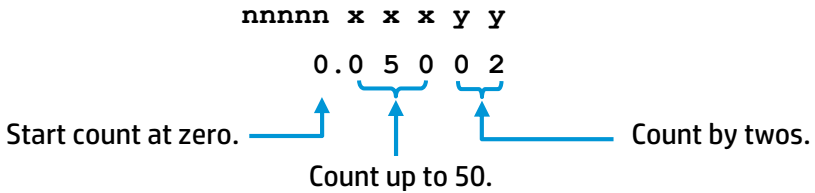

ISG and DSE Operation. Each time a program encounters **ISG** or **DSE** it increments or decrements **nnnnn** (the integer portion of the loop control number), thereby keeping count of the loop iterations. It compares **nnnnn** to **xxx**, the prescribed test value, and exits the loop by skipping the next line *if* the loop counter (**nnnnn**) is either greater than (**ISG**) or less than or equal to (**DSE**) the test value (**xxx**). The amount that **nnnnn** is incremented or decremented is specified by **yy**.

With these functions (as opposed to the other conditional tests), the rule is “Skip if True”.

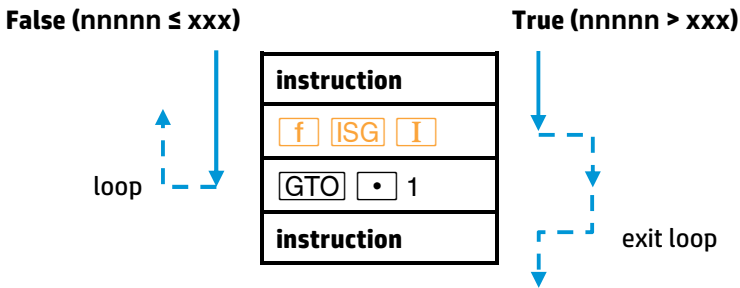

For ISG: given **nnnnn.xxyy**, increment **nnnnn** to **nnnnn + yy**, compare it to **xxx**, and skip the next program line if the new value satisfies **nnnnn > xxx**. This allows you to exit a loop at this point when **nnnnn** becomes greater than **xxx**.

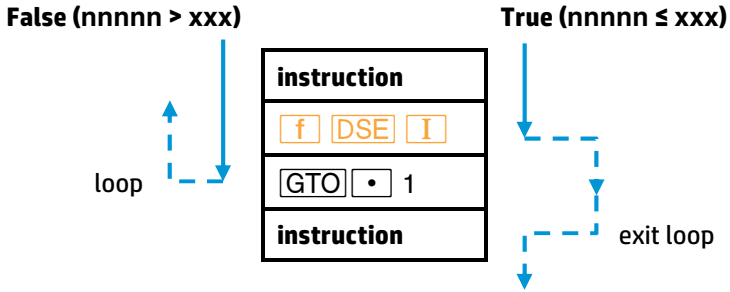

For **DSE**: given **nnnnn.xxyy**, decrement **nnnnn** to **nnnnn - yy**, compare it to **xxx**, and skip the next program line if the new value satisfies **nnnnn ≤ xxx**. This allows you to exit a loop at this point when **nnnnn** becomes less than or equal to **xxx**.

For example, loop iterations will alter these control numbers as follows:

| | | Iterations | | | | |
|------------|---------|------------|---------|-----------------------------|-----------------------------|--|
| Operation | 0 | 1 | 2 | 3 | 4 | |
| ISG | 0.00602 | 2.00602 | 4.00602 | 6.00602 | 8.00602 (skip next line) | |
| DSE | 6.00002 | 4.00002 | 2.00002 | 0.00002 (skip next line) | | |

Examples

Examples: Register Operations

Storing and Recalling

Keystrokes

f CLEAR REG

12.3456

STO I

7 **√x**

STO (i)

RCL I

Display

12 . 3456

12 . 3456

2 . 6458

2 . 6458

12 . 3456

Clears all storage registers.

Stores in R_1 .

Storage in R_2 by indirect addressing ($R_1 = 12.3456$).

Recalls contents of R_1 .

Keystrokes

Display

| | | |
|-----------------------|----------|---|
| RCL (i) | 2 . 6458 | Indirectly recalls contents of R ₂ . |
| f X↔ .2 | 2 . 6458 | Check: same contents recalled by directly addressing R ₂ . |

Exchanging the X-Register

Keystrokes

Display

| | | |
|-------------------------------|-----------|--|
| f X↔ I | 12 . 3456 | Exchanges contents of R ₁ and X-register. |
| RCL I | 2 . 6458 | Present contents of R ₁ . |
| f X↔ (i) | 0 . 0000 | Exchanges contents of R ₂ (which is zero) with X. |
| RCL (i) | 2 . 6458 | |
| f X↔ 2 | 2 . 6458 | Check: directly address R ₂ . |

Storage Register Arithmetic

Keystrokes

Display

| | | |
|--|-----------|--|
| 10 STO + I | 10 . 0000 | Adds 10 to R ₁ . |
| RCL I | 12 . 6458 | New contents of R ₁ (= old + 10). |
| g π STO ÷ (i) | 3 . 1416 | Divides contents of R ₂ by π. |
| RCL (i) | 0 . 8422 | New contents of R ₂ . |
| f X↔ .2 | 0 . 8422 | Check: directly address R ₂ . |

Example: Loop Control with **DSE**

Remember the program in Section 8 which used a loop to calculate radioactive decay? (Refer to page 93.) This program used a test condition ($x \geq y?$) to exit the loop when the calculated result passed the given limit (50). As we've seen in this section, there's another way to control loop execution: through a stored loop counter that is monitored by the **ISG** or **DSE** function.

Here is a revision of the original radioisotope decay program. This time, we will limit the program to three executions of the loop rather than setting a specific limit value. This example uses **DSE** with a loop control number in R_2 of 3. 0 0 0 0 1.



Make the following changes to the program (assuming it is in memory). A loop counter will be stored in R_2 and a line number in the Index register.

| Keystrokes | Display | |
|---------------------------|---------------|--|
| g P/R | 000- | Program mode. |
| GTO CHS 013 | 013-43, 30, 9 | The second of the two loop test condition lines. |
| ← ← | 011- 42 31 | Delete lines 013 and 012. |
| f DSE 2 | 012-42, 5, 2 | Add your loop counter function (counter stored in R_2). |
| GTO I | 013- 22 25 | Go to given line number (015). |

Now when the loop counter (stored in R_2) has reached zero, it will skip line 013 and go on to 014, the **RTN** instruction, thereby ending the program. If the loop counter has not yet decreased to zero, execution continues with line 013. This branches to line 015 and continues the program and the looping.

To run the program, put t_1 (day 1) in R_0 , N_0 (initial isotope batch) in R_1 the loop counter in R_2 , and the line number for branching in the Index register.

| Keystrokes | Display | |
|-----------------------------------|----------|--|
| g P/R | | Run mode. |
| 2 STO 0 | 2.00000 | t_1 . |
| 100 STO 1 | 100.0000 | N_0 . |
| 3.000001 STO 2 | 3.0000 | Loop counter. (This instruction could also be programmed.) |
| 15 CHS STO I | -15.0000 | Branch line number. |

114 Section 10: The Index Register and Loop Control

Keystrokes

f **A**

Display

2.0000

Running program:
loop counter = 3.

84.0896

5.0000

Loop counter = 2.

64.8420

8.0000

Loop counter = 1.

50.0000

50.0000

Loop counter = 0; program ends.

Example: Display Format Control

The following program pauses and displays an example of **FIX** display format for each possible decimal place. It utilizes a loop containing a **DSE** instruction to automatically change the number of decimal places.

Keystrokes

g **P/R**

f **CLEAR** **PRGM**

f **LBL** **B**

9

Display

000-

000-

001-42, 21, 12

002-

9 **nnnnn** = 9. Therefore,
xxx = 0 and by default **yy** = 1
(**yy** cannot be zero).

003- 44 25

004-42, 21, 0

005-42, 7, 25

006- 45 25

007- 42 31

Displays current value of **nnnnn**.
Value in R_i is decremented and
tested. Skip a line if **nnnnn** ≤
test value.

008-42, 5, 25

009- 22 0

Continue loop if **nnnnn** > test
value (0).

010-43, 30, 1

011- 22 0

Tests whether **value in display**
is greater than 0, so loop will
continue when **nnnnn** has
reached 0 but display still only
shows 1.0.

012- 43 32

STO **I**

f **LBL** 0

f **FIX** **I**

RCL **I**

f **PSE**

f **DSE** **I**

GTO 0

g **TEST** 1

GTO 0

g **RTN**

To display fixed point notation for all possible decimal places on the HP 15c:

| Keystrokes | Display | |
|---|----------------|---|
| g P/R | | Run mode. |
| f B | 9.000000000 | |
| | 8.00000000 | |
| | 7.0000000 | |
| | 6.000000 | |
| | 5.00000 | |
| | 4.0000 | |
| | 3.000 | |
| | 2.00 | |
| | 1.0 | |
| | 0. | Display at f PSE instruction. |
| | 0. | Display when program halts. |

Further Information

Index Register Contents

Any value stored in the Index register can be referenced in three different ways:

- Using I like any other storage register. The value in R_i can be manipulated as it is: stored, recalled, exchanged, added to, etc.
- Using I as a control number. The absolute value of the integer portion in R_i is a separate entity from the fractional portion. For indirect branching, flag control, and display format control with I, only this portion is used. For loop control, the fractional portion is also used, but separately from the integer portion.*
- Using (i) as a reference to the contents of another storage register. The (i) key uses the indirect addressing system shown in the tables on pages 107 and 108. (In turn, the contents of that second register may be used as a loop control number, in the fashion described above.)

* This is also true for the value in *any* storage register used for indirect loop control.

ISG and **DSE**

For the purpose of loop control, the integer portion (the counter value) of the stored control number can be up to five digits long (**nnnnn.xxxyy**). The counter value (**nnnnn**) is zero if not specified otherwise.

xxx, in the decimal portion of the control number, must be specified as a three-digit number. (For example, “5” must be “005”.) **xxx** is zero if not specified otherwise. Whenever **ISG** or **DSE** is encountered, **nnnnn** is compared internally to **xxx**, which represents the end level for incrementing or decrementing.

yy must be specified as a two-digit number. **yy** *cannot be zero*, so if left (or specified) as **00**, *the value for yy defaults to 1*. The value **nnnnn** is altered by the amount of **yy** each time the loop runs through **ISG** or **DSE**. Both **yy** and **xxx** are reference values, which do *not* change with loop execution.

Indirect Display Control

While you can use the Index register to format the display manually (that is, from the keyboard), this function is most commonly used in programming. This capability is especially valuable for the **FIX** function, for which accuracy can be stipulated by specifying the number of digits to be displayed (as described in Section 14).

There are, as usual, certain display limitations to keep in mind. Recall that any display format function merely alters the number of decimal places to which the display is rounded. In its memory, the calculator always retains a number in scientific notation as a 10-digit mantissa with a two-digit exponent.

The integer portion of the number in the Index register specifies the number of decimal places to which the display is rounded. A number less than zero defaults to zero (zero decimal places displayed in **FIX** format), while a number greater than 9 defaults to 9 (9 decimal places displayed in **FIX**).*

* Note that in **SCI** and **ENG** format modes, the maximum display is a seven-digit mantissa with a two-digit exponent. However, a format number greater than six (and less than or equal to nine) *will* alter the decimal place at which rounding occurs. (Refer to pages 58–59.)

An exception is in the case of  where the display format number in R_i may range from -6 to +9. (This is discussed in Appendix E on page 247.) A number less than zero will not affect the display format, but will affect accuracy with this function.

Part III

HP 15c

Advanced Functions

Section 11

Calculating With Complex Numbers

The HP 15c enables you to calculate with complex numbers, that is, numbers of the form

$$a + ib,$$

where a is the real part of the complex number,
 b is the imaginary part of the complex number, and
 $i = \sqrt{-1}$.

As you will see, the beauty of calculating with the HP 15c in Complex mode is that once the complex numbers are keyed in, most operations are executed in the same manner as with real numbers.

The Complex Stack and Complex Mode

Calculations with complex numbers are performed using a complex stack composed of *two* parallel four-register stacks (and two LAST X registers). One of these parallel stacks—referred to as the *real* stack—contains the real parts of complex numbers used in calculations. (This is the same stack used in ordinary calculations.) The other stack—referred to as the *imaginary* stack—contains the imaginary parts of complex numbers used in calculations.

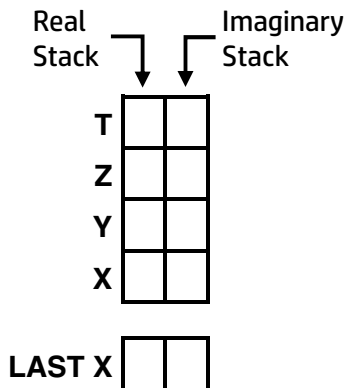

Creating the Complex Stack

The imaginary stack is created (by converting five storage registers as described in Appendix C) when you activate Complex mode; it does not exist when the calculator is not in Complex mode.

Complex mode is activated

1. automatically, when executing \boxed{f} \boxed{I} or \boxed{f} $\boxed{Re\Im}$; or
2. by setting flag 8, the Complex mode flag (\boxed{g} \boxed{SF} 8).

When the calculator is in Complex mode, the **C** annunciator in the display is lit. This tells you that flag 8 is set and the complex stack exists. In or out of Complex mode, *the number appearing in the display is the number in the real X-register.*

Note: In Complex mode (signified by the **C** annunciator), the HP 15c performs *all* trigonometric functions using *radians*. *The trigonometric mode annunciator in the display (RAD, GRAD, or blank for Degrees) applies to two functions only: $\boxed{\rightarrow R}$ and $\boxed{\rightarrow P}$ (as explained later in this section).*

Deactivating Complex Mode

Since Complex mode requires the allocation of five registers from memory, you will have more memory available for programming and other advanced functions if you deactivate Complex mode when you are working solely with real numbers.

To deactivate Complex mode, clear flag 8 (keystroke sequence: \boxed{g} \boxed{CF} 8). The **C** annunciator will disappear.

Complex mode is also deactivated when Continuous Memory is reset (as described on page 63). In any case, deactivating Complex mode dissolves the imaginary stack, and all imaginary numbers there are lost.

Complex Numbers and the Stack













Entering Complex Numbers



To enter a number with real and imaginary parts:

1. Key the real part of the number into the display.
2. Press \boxed{ENTER} .
3. Key the imaginary part of the number into the display.
4. Press \boxed{f} \boxed{I} . (If not already in Complex mode, this creates the imaginary stack and displays the **C** annunciator.)

122 Section 11: Calculating With Complex Numbers

Example: Add $2 + 3i$ and $4 + 5i$. (The operations are illustrated in the stack diagrams following the keystroke listing.)

| Keystrokes | Display | |
|--|---------|--|
|   4 | | |
| 2  | 2.0000 | Keys real part of first number into (real) Y-register. |
| 3 | 3 | Keys imaginary part of first number into (real) X-register. |
|   | 2.0000 | Creates imaginary stack; moves the 3 into the imaginary X-register, and drops the 2 into the real X-register. |
| 4  | 4.0000 | Keys real part of second number into (real) Y-register. |
| 5 | 5 | Keys imaginary part of second number into (real) X-register. |
|   | 4.0000 | Copies 5 from real X-register into imaginary X-register, copies 4 from real Y-register into real X-register, and drops stack. |
|  | 6.0000 | Real part of sum. |
|   (hold) | 8.0000 | Displays imaginary part of sum while the  key is held. |
| (release) | 6.0000 | (This also terminates digit entry.) |

The operation of the real and imaginary stacks during this process is illustrated below. (Assume that the stack registers have been loaded already with the numbers shown as the result of previous calculations). Note that the imaginary stack, which is shown below at the right of the real stack, is not created until   is pressed. (Recall also that the shading of the stack indicates that those contents will be written over when the next number is keyed in or recalled.)

Section 11: Calculating With Complex Numbers 123

| | Re | Im | Re | Im | Re | Im | Re | Im | Re | Im |
|---|----|----|----|----|----|----|----|----|----|----|
| T | 9 | | 8 | | 7 | | 7 | | 7 | 0 |
| Z | 8 | | 7 | | 6 | | 6 | | 7 | 0 |
| Y | 7 | | 6 | | 2 | | 2 | | 6 | 0 |
| X | 6 | | 2 | | 2 | | 3 | | 2 | 3 |

Keys: 2 [ENTER] 3 \boxed{f} \boxed{I}

The execution of \boxed{f} \boxed{I} causes the entire stack to drop, the T contents to duplicate, and the real X contents to move to the imaginary X-register.

When the second complex number is entered, the stacks operate as shown below. Note that [ENTER] lifts both stacks.

| | Re | Im | Re | Im | Re | Im | Re | Im |
|---|----|----|----|----|----|----|----|----|
| T | 7 | 0 | 7 | 0 | 6 | 0 | 6 | 0 |
| Z | 7 | 0 | 6 | 0 | 2 | 3 | 2 | 3 |
| Y | 6 | 0 | 2 | 3 | 4 | 0 | 4 | 0 |
| X | 2 | 3 | 4 | 0 | 4 | 0 | 5 | 0 |

Keys: 4 [ENTER] 5

| | Re | Im | Re | Im | Re | Im |
|---|----|----|----|----|----|----|
| T | 6 | 0 | 6 | 0 | 6 | 0 |
| Z | 2 | 3 | 6 | 0 | 6 | 0 |
| Y | 4 | 0 | 2 | 3 | 6 | 0 |
| X | 5 | 0 | 4 | 5 | 6 | 8 |

Keys: \boxed{f} \boxed{I} $\boxed{+}$

A second method of entering complex numbers is to enter the imaginary part first, then use $\boxed{Re \Leftarrow Im}$ and $\boxed{\leftarrow}$. This method is illustrated under Entering Complex Numbers with $\boxed{\leftarrow}$, page 127.

Stack Lift in Complex Mode

Stack lift operates on the imaginary stack as it does on the real stack (the real stack behaves identically in and out of Complex mode). *The same functions that enable, disable, or are neutral to lifting of the real stack will enable, disable, or be neutral to lifting of the imaginary stack.* (These processes are explained in detail in Section 3 and Appendix B.)

In addition, every non-neutral function except \leftarrow and CLX causes the clearing of the imaginary X-register when the next number is entered. That is, these functions cause a zero to be placed in the imaginary X-register when the next number is keyed in or recalled. Refer to the stack diagrams above for illustrations. This feature allows you to execute calculator operations using the same key sequences you use outside of Complex mode.*

Manipulating the Real and Imaginary Stacks

$\text{Re}\leftrightarrow\text{Im}$ (real exchange imaginary). Pressing f $\text{Re}\leftrightarrow\text{Im}$ will exchange the contents of the real and imaginary X-registers, thereby converting the imaginary part of the number into the real part and vice-versa. The Y-, Z-, and T-registers are *not* affected. Press f $\text{Re}\leftrightarrow\text{Im}$ twice to restore a number to its original form.

$\text{Re}\leftrightarrow\text{Im}$ also activates Complex mode if it is not already activated.

Temporary Display of the Imaginary X-Register. Press f (i) to momentarily display the imaginary part of the number in the X-register without actually switching the real and imaginary parts. Hold the key down to maintain the display.

Changing Signs

In Complex mode, the CHS function affects only the number in the real X-register—the imaginary X-register does not change. This enables you to change the sign of the real or imaginary part without affecting the other. To key in a negative real or imaginary part, change the sign of that part as you enter it.

If you want to find the additive inverse of a complex number *already in the X-register*, however, you cannot simply press CHS as you would outside of Complex mode. Instead, you can do either of the following:

* Except for the P and R functions, as explained in this section (page 133).

- Multiply by -1 .
- If you don't want to disturb the rest of the stack, press $\boxed{\text{CHS}}$ $\boxed{\text{f}}$ $\boxed{\text{Re}\rightrightarrows\text{Im}}$ $\boxed{\text{CHS}}$ $\boxed{\text{f}}$ $\boxed{\text{Re}\rightrightarrows\text{Im}}$.

To find the negative of only one part of a complex number in the X-register:

- Press $\boxed{\text{CHS}}$ to negate the *real part only*.
- Press $\boxed{\text{f}}$ $\boxed{\text{Re}\rightrightarrows\text{Im}}$ $\boxed{\text{CHS}}$ $\boxed{\text{f}}$ $\boxed{\text{Re}\rightrightarrows\text{Im}}$ to negate the *imaginary part only*, forming the complex conjugate.

Clearing a Complex Number

Inevitably you will need to clear a complex number. You can clear only one part at a time, but you can then write over both parts (since $\boxed{\leftarrow}$ and $\boxed{\text{CLX}}$ disable the stack).

Clearing the Real X-Register. Pressing $\boxed{\leftarrow}$ (or $\boxed{\text{g}}$ $\boxed{\text{CLX}}$) with the calculator in Complex mode clears only the number in the real X-register; it does *not* clear the number in the imaginary X-register.

Example: Change $6 + 8i$ to $7 + 8i$ and subtract it from the previous entry. (Use $\boxed{\text{f}}$ $\boxed{\text{Re}\rightrightarrows\text{Im}}$ or $\boxed{\text{f}}$ $\boxed{\text{(i)}}$ to view the imaginary part in X.) Assume a , b , c , and d represent parts of complex numbers.

| | Re | Im | Re | Im | Re | Im | Re | Im |
|---|-----|-----|-----|-----|-----|-----|-----|-----|
| T | a | b | a | b | a | b | a | b |
| Z | c | d | c | d | c | d | a | b |
| Y | 6 | 0 | 6 | 0 | 6 | 0 | c | d |
| X | 6 | 8 | 0 | 8 | 7 | 8 | -1 | -8 |

Keys: $\boxed{\leftarrow}$ 7 $\boxed{-}$ (or other operation)

Since clearing disables the stack (as explained above), the next number you enter will replace the cleared value. If you want to replace the real part with zero, after clearing use $\boxed{\text{ENTER}}$ or any other function to terminate digit entry (otherwise the next number you enter will write over the zero); the imaginary part will remain unchanged. You can then continue with any calculator function.

126 Section 11: Calculating With Complex Numbers

Clearing the Imaginary X-Register. To clear the number in the imaginary X-register, press \boxed{f} $\boxed{\text{Re}\Im}$, then press $\boxed{\leftarrow}$. Press \boxed{f} $\boxed{\text{Re}\Im}$ again to return the zero, or any new number keyed in, to the imaginary X-register.

Example: Replace $-1 - 8i$ by $-1 + 5i$.

| | Re | Im | Re | Im | Re | Im | Re | Im | Re | Im |
|---|------|------|------|------|-----|------|-----|------|------|-----|
| T | a | b | a | b | a | b | a | b | a | b |
| Z | c | d | c | d | c | d | c | d | c | d |
| Y | e | f | e | f | e | f | e | f | e | f |
| X | -1 | -8 | -8 | -1 | 0 | -1 | 5 | -1 | -1 | 5 |

Keys: \boxed{f} $\boxed{\text{Re}\Im}$ $\boxed{\leftarrow}$ 5 \boxed{f} $\boxed{\text{Re}\Im}$
 (continue with any operation)

Clearing the Real and Imaginary X-Registers. If you want to clear or replace *both* the real and imaginary parts of the number in the X-register, simply press $\boxed{\leftarrow}$, which will disable the stack, and enter your new number. (Enter zeros if you want the X-register to contain zeros.) Alternatively, if the new number will be purely real (including $0 + 0i$), you can quickly clear or replace the old, complex number by pressing $\boxed{\text{R}\downarrow}$ followed by zero or the new, real number.

Example: Replace $-1 + 5i$ with $4 + 7i$.

| | Re | Im | Re | Im | Re | Im | Re | Im | Re | Im |
|---|------|-----|-----|-----|-----|-----|-----|-----|-----|-----|
| T | a | b | a | b | c | d | c | d | c | d |
| Z | c | d | c | d | e | f | e | f | c | d |
| Y | e | f | e | f | 4 | 5 | 4 | 5 | e | f |
| X | -1 | 5 | 0 | 5 | 4 | 5 | 7 | 0 | 4 | 7 |

Keys: $\boxed{\leftarrow}$ 4 $\boxed{\text{ENTER}}$ 7 \boxed{f} $\boxed{\text{I}}$
 (continue with any operation)

Entering Complex Numbers with \leftarrow . The clearing functions \leftarrow and **CLX** can also be used with **Re \rightarrow Im** as an alternative method of entering (and clearing) complex numbers. Using this method, you can enter a complex number using only the X-register, without affecting the rest of the stack. (This is possible because \leftarrow and **CLX** disable stack lift.) Executing **Re \rightarrow Im** will also create an imaginary stack if one is not already present.

Example: Enter $9 + 8i$ without moving the stack and then find its square.

| Keystrokes | Display | |
|--|----------|--|
| \leftarrow | (0.0000) | Prevents stack lift when the next digit (8) is keyed in. Omit this step if you'd rather save what's in X and lose what's in T. |
| 8 | 8 | Enter imaginary part first. |
| f Re\rightarrowIm | 7.0000 | Displays real part; Complex mode activated. |
| \leftarrow | 0.0000 | Disables stack. (Otherwise, it would lift following Re\rightarrowIm .) |
| 9 | 9 | Enters real part (digit entry not terminated). |
| g x² | 17.0000 | Real part. |
| f (i) (hold) | 144.0000 | Imaginary part. |
| (release) | 17.0000 | |

| | Re | Im | Re | Im | Re | Im | Re | Im |
|---|----|----|----|----|----|----|----|----|
| T | a | b | a | b | a | b | a | b |
| Z | c | d | c | d | c | d | c | d |
| Y | e | f | e | f | e | f | e | f |
| X | 4 | 7 | 0 | 7 | 8 | 7 | 7 | 8 |

Keys: \leftarrow 8 **f** **Re \rightarrow Im**

128 Section 11: Calculating With Complex Numbers

| | Re | Im |
|---|-----|-----|
| T | a | b |
| Z | c | d |
| Y | e | f |
| X | 7 | 8 |

| | Re | Im |
|---|-----|-----|
| T | a | b |
| Z | c | d |
| Y | e | f |
| X | 0 | 8 |

| | Re | Im |
|---|-----|-----|
| T | a | b |
| Z | c | d |
| Y | e | f |
| X | 9 | 8 |

| | Re | Im |
|---|-----|-----|
| T | a | b |
| Z | c | d |
| Y | e | f |
| X | 17 | 144 |

Keys:



9



Entering a Real Number

You have already seen two ways of entering a complex number. There is a shorter way to enter a real number: simply key it (or recall it) into the display just as you would if the calculator were not in Complex mode. As you do so, a zero will be placed in the imaginary X-register (as long as the previous operation was not or , as explained on page 124).

The operation of the real and imaginary stacks during this process is illustrated below. (Assume the last key pressed was not or and the contents remain from the previous example.)

| | Re | Im |
|---|-----|-----|
| T | a | b |
| Z | c | d |
| Y | e | f |
| X | 17 | 144 |

| | Re | Im |
|---|-----|-----|
| T | c | d |
| Z | e | f |
| Y | 17 | 144 |
| X | 4 | 0 |

| | Re | Im |
|---|-----|-----|
| T | e | f |
| Z | 17 | 144 |
| Y | 4 | 0 |
| X | 4 | 0 |

Keys:

4



(Followed by another number.)

Entering a Pure Imaginary Number

There is a shortcut for entering a pure imaginary number into the X-register when you are already in Complex mode: key in the (imaginary) number and press **f** **Re↔Im**.

Example: Enter $0 + 10i$ (assuming the last function executed was not **CLX** or **←**).

Keystrokes

10

Display

10

Keys 10 into the displayed real X-register and zero into the imaginary X-register.

f **Re↔Im**

0.0000

Exchanges numbers in real and imaginary X-registers. Display again shows that the number in the real X-register is zero—as it should be for a pure imaginary number.

The operation of the real and imaginary stacks during this process is illustrated below. (Assume the stack registers contain the numbers resulting from the preceding examples.)

| | Re | Im | Re | Im | Re | Im |
|---|----------|----------|----------|----------|----------|----------|
| T | <i>e</i> | <i>f</i> | <i>e</i> | <i>f</i> | <i>e</i> | <i>f</i> |
| Z | 17 | 144 | 17 | 144 | 17 | 144 |
| Y | 4 | 0 | 4 | 0 | 4 | 0 |
| X | 4 | 0 | 10 | 0 | 0 | 10 |

Keys:

10

f **Re↔Im**

(Continue with any operation.)

130 Section 11: Calculating With Complex Numbers

Note that pressing \boxed{f} $\boxed{\text{Re}\leftrightarrow\text{Im}}$ simply exchanges the numbers in the real and imaginary *X-registers* and *not* those in the remaining stack registers.

Storing and Recalling Complex Numbers

The $\boxed{\text{STO}}$ and $\boxed{\text{RCL}}$ functions act on the *real X-register only*; therefore, the imaginary part of a complex number must be stored or recalled separately. The keystrokes to do this can be entered as part of a program and executed automatically.*

To store $a + ib$ from the complex X-register to R_1 and R_2 , you can use the sequence

$\boxed{\text{STO}}$ 1 \boxed{f} $\boxed{\text{Re}\leftrightarrow\text{Im}}$ $\boxed{\text{STO}}$ 2

You can follow this by \boxed{f} $\boxed{\text{Re}\leftrightarrow\text{Im}}$ to return the stack to its original condition if desired. To recall $a + ib$ from R_1 and R_2 you can use the sequence

$\boxed{\text{RCL}}$ 1 $\boxed{\text{RCL}}$ 2 \boxed{f} $\boxed{\text{I}}$

If you wish to avoid disturbing the rest of the stack, you can recall the number using the sequence

$\boxed{\text{RCL}}$ 2 \boxed{f} $\boxed{\text{Re}\leftrightarrow\text{Im}}$ $\boxed{\leftarrow}$ $\boxed{\text{RCL}}$ 1.

(In Program mode, use \boxed{g} $\boxed{\text{CLX}}$ instead of $\boxed{\leftarrow}$.)

Operations With Complex Numbers

Almost all functions performed on *real numbers* will yield the same answer whether executed in or out of Complex mode,[†] *assuming the result is also real*. In other words, Complex mode does not restrict your ability to calculate with real numbers.

Any functions not mentioned below or in the rest of this section (Calculating With Complex Numbers) ignore the imaginary stack.

* You can use the HP 15c matrix functions, described in Section 12, to make storing and recalling complex numbers more convenient. By dimensioning a matrix to be $n \times 2$, n complex numbers can be stored as rows of the matrix. (This technique is demonstrated in the *HP 15c Advanced Functions Handbook*, Section 3, under Applications.)

[†] The exceptions are $\boxed{\rightarrow\text{P}}$ and $\boxed{\rightarrow\text{R}}$, which operate differently in Complex mode in order to facilitate converting complex numbers to polar form (page 133).

One-Number Functions

The following functions operate on both the real and imaginary parts of the number in the X-register, and place the real and imaginary parts of the answer back into those registers.

\sqrt{x} x^2 LN LOG $1/x$ 10^x e^x ABS $\rightarrow P$ $\rightarrow R$

All trigonometric and hyperbolic functions and their inverses also belong to this group.*

The **ABS** function gives the magnitude of the number in the X-registers (the square root of the sum of the squares of the real and imaginary parts); the imaginary part of the magnitude is zero.

$\rightarrow P$ converts to polar form and $\rightarrow R$ converts to rectangular form, as described later in this section (page 133).

For the trigonometric functions, the calculator considers numbers in the real and imaginary X-registers to be expressed in *radians*—regardless of the current trigonometric mode. To calculate trigonometric functions for values given in degrees, use $\rightarrow RAD$ to convert those values to radians before executing the trigonometric function.

Two-Number Functions

The following functions operate on both the real and imaginary parts of the numbers in the X- and Y-registers, and place the real and imaginary parts of the answer into the X-registers. Both stacks drop, just as the ordinary stack drops after a two-number function *not* in Complex mode.

+ − × ÷ y^x

Stack Manipulation Functions

When the calculator is in Complex mode, the following functions simultaneously manipulate both the real and imaginary stacks in the same way as they manipulate the ordinary stack when the calculator is not in Complex mode. The $X \leftrightarrow Y$ function, for instance, will exchange *both* the real and imaginary parts of the numbers in the X- and Y-registers.

$X \leftrightarrow Y$ R↓ R↑ ENTER LSTX

* Refer to the *HP 15c Advanced Functions Handbook* for definitions of complex trigonometric functions and further information about doing calculations in Complex mode.

Conditional Tests

For programming, the four conditional tests below will work in the complex sense: `x=0` and `TEST 0` compare the *complex* number in the (real and imaginary) X-registers to $0 + 0i$, while `TEST 5` and `TEST 6` compare the *complex* numbers in the (real and imaginary) X- and Y-registers. All other conditional tests besides those listed below ignore the imaginary stack.

`x=0` `TEST 0` ($x \neq 0$) `TEST 5` ($x = y$) `TEST 6` ($x \neq y$)

Example: Complex Arithmetic. The characteristic impedance of a ladder network is given by an equation of the form

$$Z_0 = \sqrt{\frac{A}{B}},$$

where A and B are complex numbers. Find Z_0 for the hypothetical values $A = 1.2 + 4.7i$ and $B = 2.7 + 3.2i$.

Keystrokes

Display

| | | |
|--|----------|---|
| 1.2 <code>ENTER</code> 4.7 <code>f</code> <code>I</code> | 1 . 2000 | Enters A into real and imaginary X-registers. |
| 2.7 <code>ENTER</code> 3.2 <code>f</code> <code>I</code> | 2 . 7000 | Enters B into real and imaginary X-registers, moving A into real and imaginary Y-registers. |
| <code>÷</code> | 1 . 0428 | Calculates A/B . |
| <code>√x</code> | 1 . 0491 | Calculates Z_0 and displays real part. |
| <code>f</code> <code>(i)</code> (hold) | 0 . 2406 | Displays imaginary part of Z_0 while <code>(i)</code> is held down. |
| (release) | 1 . 0491 | Again displays real part of Z_0 . |

Complex Results from Real Numbers

In the preceding examples, the entry of complex numbers had ensured the (automatic) activation of Complex mode. There will be times, however, when you will need Complex mode to perform certain operations on *real* numbers, such as $\sqrt{-5}$. (Without Complex mode, such as operation would result in an **Error 0**—improper math function.) To activate Complex mode at any time *and without disturbing the stack contents*, set flag 8 before executing the function in question.*

Example: The arcsine (\sin^{-1}) of 2.404 normally would result in an **Error 0**. Assuming 2.404 in the X-register, the complex value $\arcsin 2.404$ can be calculated as follows:

| Keystrokes | Display | |
|----------------------------------|-----------|--|
| \boxed{g} \boxed{SF} 8 | | Activates Complex Mode. |
| \boxed{g} $\boxed{SIN^{-1}}$ | 1 . 5708 | Real part of $\arcsin 2.404$. |
| \boxed{f} $\boxed{(i)}$ (hold) | -1 . 5239 | Imaginary part of $\arcsin 2.404$. |
| (release) | 1 . 5708 | Display shows real part again when $\boxed{(i)}$ is released. |

Polar and Rectangular Coordinate Conversions

In many applications, complex numbers are represented in polar form, sometimes using phasor notation. However, the HP 15c assumes that any complex numbers are in *rectangular* form. Therefore, any numbers in polar or phasor form must be converted to rectangular form before performing a function in Complex mode.

* Pressing \boxed{f} $\boxed{Re\Im}$ *twice* will accomplish the same thing. The sequence \boxed{f} \boxed{I} is not used because it would combine any numbers in the real X- and Y-registers into a single complex number.

134 Section 11: Calculating With Complex Numbers

$$a + ib = \begin{cases} r(\cos \theta + i \sin \theta) = re^{i\theta} & \text{(polar)} \\ r \angle \theta & \text{(phasor)} \end{cases}$$

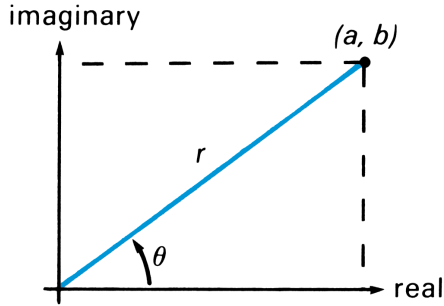

→R and **→P** can be used to interconvert the rectangular and polar forms of a complex number. They operate *in Complex mode* as follows:

f **→R** converts the polar (or phasor) form of a complex number to its rectangular form by replacing the magnitude r in the real X-register with a , and replacing the angle θ in the imaginary X-register with b .

g **→P** converts the rectangular coordinates of a complex number to the polar (or phasor) form by replacing the real part a in the real X-register with r , and replacing the imaginary part b in the imaginary X-register with θ .

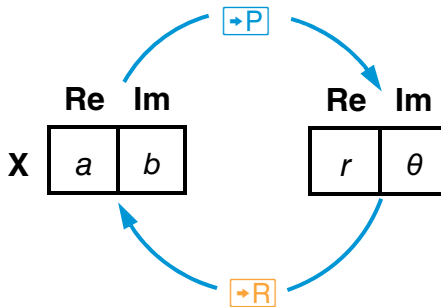

These are the only functions in Complex mode that are affected by the current trigonometric mode setting. That is, the angular units for θ must correspond to the trigonometric mode indicated by the annunciator (or absence thereof).

Example: Find the sum $2(\cos 65^\circ + i \sin 65^\circ) + 3(\cos 40^\circ + i \sin 40^\circ)$ and express the result in polar form. (In phasor form, evaluate $2\angle 65^\circ + 3\angle 40^\circ$.)

| Keystrokes | Display | |
|----------------------------------|---------|--|
| \boxed{g} \boxed{DEG} | | Sets Degrees mode for any polar-rectangular conversions. |
| 2 \boxed{ENTER} | 2.0000 | |
| 65 \boxed{f} \boxed{I} | 2.0000 | C annunciator displayed; Complex mode activated. |
| \boxed{f} $\boxed{+R}$ | 0.8452 | Converts polar to rectangular form; real part (a) displayed. |
| 3 \boxed{ENTER} | 3.0000 | |
| 40 \boxed{f} \boxed{I} | 3.0000 | |
| \boxed{f} $\boxed{+R}$ | 2.2981 | Converts polar to rectangular form; real part (a) displayed. |
| $\boxed{+}$ | 3.1434 | |
| \boxed{g} $\boxed{+P}$ | 4.8863 | Converts rectangular to polar form; r displayed. |
| \boxed{f} $\boxed{(i)}$ (hold) | 49.9612 | θ (in degrees). |
| (release) | 4.8863 | |

Problems

By working through the following problems, you will see that calculating with complex numbers on the HP 15c is as easy as calculating with real numbers. In fact, once your numbers are entered, most mathematical operations will use exactly the same keystrokes. Try it and see!

1. Evaluate:

$$\frac{2i(-8 + 6i)^3}{(4 - 2\sqrt{5}i)(2 - 4\sqrt{5}i)}$$

136 Section 11: Calculating With Complex Numbers

| Keystrokes | Display | |
|----------------------------|-------------|--|
| 2 f Re↔Im | 0.0000 | 2i. Display shows real part. |
| 8 CHS ENTER | -8.0000 | |
| 6 f I | -8.0000 | -8 + 6i. |
| 3 y^x | 352.0000 | $(-8 + 6i)^3$. |
| × | -1.872.0000 | $2i(-8 + 6i)^3$. |
| 4 ENTER | 4.0000 | |
| 5 √x | 2.2361 | |
| 2 CHS × | -4.4721 | $-2\sqrt{5}$. |
| f I | 4.0000 | $4 - 2\sqrt{5}i$. |
| ÷ | -295.4551 | $\frac{2i(-8 + 6i)^3}{4 - 2\sqrt{5}i}$. |
| 2 ENTER 5 √x | 2.2361 | |
| 4 CHS × | -8.9443 | |
| f I | 2.0000 | $2 - 4\sqrt{5}i$. |
| ÷ | 9.3982 | Real part of result. |
| f (i) | -35.1344 | } Answer: 9.3982 - 35.1344i. |
| | 9.3982 | |

2. Write a program to evaluate the function $\omega = \frac{2z + 1}{5z + 3}$ for different values of z . (ω represents a linear fractional transformation, a class of conformal mappings.) Evaluate ω for $z = 1 + 2i$.

(Answer: $0.3902 + 0.0122i$. One possible keystroke sequence is: **f** **LBL** **A** **ENTER** **ENTER** 2 **×** 1 **+** **↔xy** 5 **×** 3 **+** **÷** **R/S** **f** **Re↔Im** **g** **RTN**.)

3. Try your hand at a complex polynomial and rework the example on page 80. You can use the same program to evaluate $P(z) = 5z^4 + 2z^3$, where z is some complex number.

Load the stack with $z = 7 + 0i$ and see if you get the same answer as before.

(Answer: $12,691.0000 + 0.0000i$.)

Now run the program for $z = 1 + i$.

(Answer $-24.0000 + 4.0000i$.)

For Further Information

The *HP 15c Advanced Functions Handbook* presents more detailed and technical aspects of using complex numbers in various functions with the HP 15c. Applications are included. The topics include:

- Accuracy considerations.
- Principal branches of multivalued functions.
- Complex contour integrals.
- Complex potentials.
- Storing and recalling complex numbers using a matrix.
- Calculating the n th roots of a complex number.
- Solving an equation for its complex roots.
- Using **SOLVE** and $\int \frac{x}{y}$ in Complex mode.

Section 12

Calculating With Matrices

The HP 15c enables you to perform matrix calculations, giving you the capability to handle advanced problems with ease. The calculator can work with up to five matrices, which are named **A** through **E** since they are accessed using the corresponding **[A]** through **[E]** keys. The HP 15c lets you specify the size of each matrix, store and recall the values of matrix elements, and perform matrix operations—for matrices with real or complex elements. (A summary of matrix functions is listed at the end of this section.)

A common application of matrix calculations is solving a system of linear equations. For example, consider the equations

$$3.8x_1 + 7.2x_2 = 16.5$$

$$1.3x_1 - 0.9x_2 = -22.1$$

for which you must determine the values of x_1 and x_2 .

These equations can be expressed in matrix form as $\mathbf{AX} = \mathbf{B}$, where

$$\mathbf{A} = \begin{bmatrix} 3.8 & 7.2 \\ 1.3 & -0.9 \end{bmatrix}, \quad \mathbf{X} = \begin{bmatrix} x_1 \\ x_2 \end{bmatrix}, \quad \text{and} \quad \mathbf{B} = \begin{bmatrix} 16.5 \\ -22.1 \end{bmatrix}.$$

The following keystrokes show how easily you can solve this matrix problem using your HP 15c. (The matrix operations used in this example are explained in detail later in this section.)

First, dimension the two known matrices, **A** and **B**, and enter the values of their elements, from left to right along each row from the first row to the last. Also, designate matrix **C** as the matrix that you will use to store the result of your matrix calculation ($\mathbf{C} = \mathbf{X}$).

| Keystrokes | Display | |
|---|---------------|--|
| g CF 8 | | Deactivates Complex mode. |
| 2 ENTER f DIM A | 2.0000 | Dimensions matrix A to be 2×2 . |
| f MATRIX 1 | 2.0000 | Prepares for automatic entry of matrix elements in User mode. |
| f USER | 2.0000 | (Turns on the USER annunciator.) |
| 3.8 STO A | A 1, 1 | Denotes matrix A , row 1, column 1. (A display like this appears momentarily as you enter each element and remains as long as you hold the letter key.) |
| | 3.8000 | Stores a_{11} . |
| 7.2 STO A | 7.2000 | Stores a_{12} . |
| 1.3 STO A | 1.3000 | Stores a_{21} . |
| .9 CHS STO A | -0.9000 | Stores a_{22} . |
| 2 ENTER 1 f DIM B | 1.0000 | Dimensions matrix B to be 2×1 . |
| 16.5 STO B | 16.5000 | Stores b_{11} . |
| 22.1 CHS STO B | -22.1000 | Stores b_{21} . |
| f RESULT C | -22.1000 | Designates matrix C for storing the result. |

Using matrix notation, the solution of the matrix equation $\mathbf{AX} = \mathbf{B}$ is

$$\mathbf{X} = \mathbf{A}^{-1}\mathbf{B}$$

where \mathbf{A}^{-1} is the inverse of matrix **A**. You can perform this operation by entering the “descriptors” for matrices **B** and **A** into the Y- and X-registers and then pressing $\boxed{\div}$. (A descriptor shows the name and dimensions of a matrix.) Note that if **A** and **B** were numbers, you could calculate the answer in a similar manner.

| Keystrokes | Display | |
|-----------------------------------|----------------|--|
| RCL MATRIX B | b | 2 1 Enters descriptor for B , the 2×1 constant matrix. |
| RCL MATRIX A | A | 2 2 Enters descriptor for A , the 2×2 coefficient matrix, into the X-register, moving the descriptor for B into the Y-register. |
| ÷ | running | Temporary display while $\mathbf{A}^{-1}\mathbf{B}$ is being calculated and stored in matrix C . |
| | C | 2 1 Descriptor for the result matrix, C , a 2×1 matrix. |

Now recall the elements of matrix **C**—the solution to the matrix equation. (Also remove the calculator from User mode and clear all matrices.)

| Keystrokes | Display | |
|--------------------------|--------------|--|
| RCL C | C 1,1 | Denotes matrix C , row 1, column 1. |
| | -11.2887 | Value of c_{11} (x_1). |
| RCL C | 8.2496 | Value of c_{21} (x_2). |
| f USER | 8.2496 | Deactivates User mode. |
| f MATRIX 0 | 8.2496 | Clears all matrices. |

The solution to the system of equations is $x_1 = -11.2887$ and $x_2 = 8.2496$.

Note: The description of matrix calculations in this section presumes that you are already familiar with matrix theory and matrix algebra.

Matrix Dimensions

Up to 64 matrix elements can be stored in memory. You can use all 64 elements in one matrix or distribute them among up to five matrices.

Matrix inversion and determinants can be performed on a matrix up to 8×8 with real elements (or on a 4×4 matrix with complex elements, as described later*).

To conserve memory, all matrices are initially dimensioned as 0×0 . When a matrix is dimensioned or redimensioned, the proper number of registers is automatically allocated in memory. You may have to increase the number of registers allocated to matrix memory before dimensioning a matrix or before performing certain matrix operations. Appendix C describes how memory is organized, how to determine the number of registers currently available for storing matrix elements, and how to increase or decrease that number.

Dimensioning a Matrix

To dimension a matrix to have y rows and x columns, place those numbers in the Y- and X-registers, respectively, and then execute \boxed{f} $\boxed{\text{DIM}}$ followed by the letter key specifying the matrix:

1. Key the number of rows (y) into the display, then press $\boxed{\text{ENTER}}$ to lift it into the Y-register.
2. Key the number of columns (x) into the X-register.
3. Press \boxed{f} $\boxed{\text{DIM}}$ followed by a letter key, $\boxed{\text{A}}$ through $\boxed{\text{E}}$, that specifies the name of the matrix.[†]

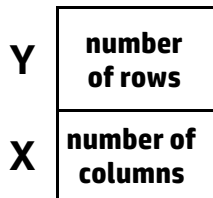

* The matrix functions described in this section operate on real matrices only. (In Complex mode, the imaginary stack is ignored during matrix operation.) However, the HP 15c has four matrix functions that enable you to calculate using real *representations* of complex matrices, as described on pages 160–173.

[†] You don't need to press \boxed{f} before the letter key. (Refer to Abbreviated Key Sequences on page 78.)

142 Section 12: Calculating with Matrices

Example: Dimension matrix **A** to be a 2×3 matrix.

| Keystrokes | Display | |
|------------------------------|----------|---|
| 2 ENTER | 2 . 0000 | Keys number of rows into Y-register. |
| 3 | 3 | Keys number of columns into X-register. |
| f DIM A | 3 . 0000 | Dimensions matrix A to be 2×3 . |

Displaying Matrix Dimensions

There are two ways you can display the dimensions of a matrix:

- Press **RCL** **MATRIX** followed by the letter key specifying the matrix. The calculator displays the name of the matrix at the left, and the number of rows followed by the number of columns at the right.
- Press **RCL** **DIM** followed by the letter key specifying the matrix. The calculator places the number of rows in the Y-register and the number of columns in the X-register.

| Keystrokes | Display | |
|---------------------------------------|--------------|--|
| RCL MATRIX B | b 0 0 | Matrix B has 0 rows and 0 columns, since it has not been dimensioned otherwise. |
| RCL DIM A | 3 . 0000 | Number of columns in A . |
| X\leftrightarrowY | 2 . 0000 | Number of rows in A . |

Changing Matrix Dimensions

Values of matrix elements are stored in memory in order from left to right along each row, from the first row to the last. If you redimension a matrix to a smaller size, the required values are reassigned according to the new dimensions and the extra values are lost. For example, if the 2×3 matrix shown at the left below is redimensioned to 2×2 , then

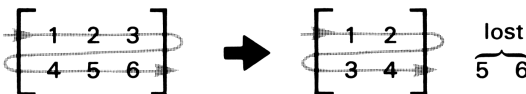

If you redimension a matrix to a larger size, elements with the value 0 are added at the end as required by the new dimensions. For example, if the same 2×3 matrix is re dimensioned, to 2×4 , then

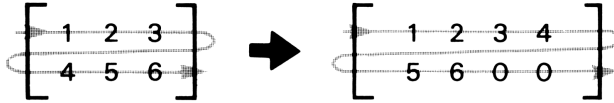

When you have finished calculating with matrices, you'll probably want to redimension all five matrices to 0×0 , so that the registers used for storing their elements will be available for program lines or for other advanced functions. You can redimension all five matrices to 0×0 at one time by pressing $\boxed{f} \boxed{\text{MATRIX}} 0$. (You can dimension a single matrix to 0×0 by pressing $0 \boxed{f} \boxed{\text{DIM}} \{ \boxed{A} \text{ through } \boxed{E} \}$.)

Storing and Recalling Matrix Elements

The HP 15c provides two ways of storing and recalling values of matrix elements. The first method allows you to progress through all of the elements in order. The second method allows you to access elements individually.

Storing and Recalling All Elements in Order

The HP 15c normally uses storage registers R_0 and R_1 to indicate the row and column numbers of a matrix element. If the calculator is in User mode, the row and column numbers are *automatically* incremented as you store or recall each matrix element, from left to right along each row from the first row to the last.

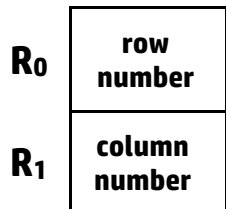

To set the row and column numbers in R_0 and R_1 to row 1, column 1, press $\boxed{f} \boxed{\text{MATRIX}} 1$.

144 Section 12: Calculating with Matrices

To store or recall sequential elements of a matrix:

1. Be sure the matrix is properly dimensioned.
2. Press \boxed{f} $\boxed{\text{MATRIX}}$ 1. This stores 1 in both storage registers R_0 and R_1 , so that elements will be accessed starting at row 1, column 1.
3. Activate User mode by pressing \boxed{f} $\boxed{\text{USER}}$. With the calculator in User mode, after each element is stored or recalled the row number in R_0 or the column number in R_1 is automatically incremented by 1, as shown in the example following.
4. If you are storing elements, key in the value of the element to be stored in row 1, column 1.
5. Press $\boxed{\text{STO}}$ or $\boxed{\text{RCL}}$ followed by the letter key specifying the matrix.
6. Repeat steps 4 and 5 for all elements of the matrix. The row and column numbers are incremented according to the dimensions of the matrix you specify.

While the letter key specifying the matrix is held down after $\boxed{\text{STO}}$ or $\boxed{\text{RCL}}$ is pressed, the calculator displays the name of the matrix followed by the row and column numbers of the element whose value is being stored or recalled. If the letter key is held down for longer than about 3 seconds, the calculator displays **null**, doesn't store or recall the element value, and doesn't increment the row and column numbers. (Also, the stack registers aren't changed.)

After the last element of the matrix has been accessed, the row and column numbers both return to 1.

Example: Store the values shown below in the elements of the matrix **A** dimensioned above. (Be sure matrix **A** is dimensioned to 2×3 .)

$$\mathbf{A} = \begin{bmatrix} a_{11} & a_{12} & a_{13} \\ a_{21} & a_{22} & a_{23} \end{bmatrix} = \begin{bmatrix} 1 & 2 & 3 \\ 4 & 5 & 6 \end{bmatrix}$$

| Keystrokes | Display | |
|--------------------------------|---------|---|
| \boxed{f} \boxed{MATRIX} 1 | | Sets beginning row and column numbers in R_0 and R_1 to 1. (Display shows the previous result.) |
| \boxed{f} \boxed{USER} | | Activates User mode. |
| 1 \boxed{STO} \boxed{A} | A 1, 1 | Row 1, column 1 of A . (Displayed momentarily while \boxed{A} key held down.) |
| | 1.0000 | Value of a_{11} . |
| 2 \boxed{STO} \boxed{A} | 2.0000 | Value of a_{12} . |
| 3 \boxed{STO} \boxed{A} | 3.0000 | Value of a_{13} . |
| 4 \boxed{STO} \boxed{A} | 4.0000 | Value of a_{21} . |
| 5 \boxed{STO} \boxed{A} | 5.0000 | Value of a_{22} . |
| 6 \boxed{STO} \boxed{A} | 6.0000 | Value of a_{23} . |
| \boxed{RCL} \boxed{A} | A 1, 1 | Recalls element in row 1, column 1. (R_0 and R_1 were reset in preceding step.) |
| | 1.0000 | Value of a_{11} . |
| \boxed{RCL} \boxed{A} | 2.0000 | Value of a_{12} . |
| \boxed{RCL} \boxed{A} | 3.0000 | Value of a_{13} . |
| \boxed{RCL} \boxed{A} | 4.0000 | Value of a_{21} . |
| \boxed{RCL} \boxed{A} | 5.0000 | Value of a_{22} . |
| \boxed{RCL} \boxed{A} | 6.0000 | Value of a_{23} . |
| \boxed{f} \boxed{USER} | 6.0000 | Deactivates User mode. |

Checking and Changing Matrix Elements Individually

The calculator provides two ways to check (recall) and change (store) the value of a particular matrix element. The first method uses storage registers R_0 and R_1 in the same way as described above—except that the row and column numbers aren't automatically changed when User mode is deactivated. The second method uses the stack to define the row and column numbers.

146 Section 12: Calculating with Matrices

Using R_0 and R_1 . To access a particular matrix element, store its row number in R_0 and its column number in R_1 . These numbers won't change automatically (unless the calculator is in User mode).

- To recall the element value (after storing the row and column numbers), press $\boxed{\text{RCL}}$ followed by the letter key specifying the matrix.
- To store a value in that element (after storing the row and column numbers), place the value in the X-register and press $\boxed{\text{STO}}$ followed by the letter key specifying the matrix.

Example: Store the value 9 as the element in row 2, column 3 of matrix **A** from the previous example.

| Keystrokes | Display | |
|---|---------------------------|--|
| 2 $\boxed{\text{STO}}$ 0 | 2 . 0000 | Stores row number in R_0 . |
| 3 $\boxed{\text{STO}}$ 1 | 3 . 0000 | Stores column number in R_1 . |
| 9 | 9 | Keys the new element value into the X-register. |
| $\boxed{\text{STO}}$ $\boxed{\text{A}}$ | A 2, 3 9 . 0000 | Row 2, column 3 of A . Value of a_{23} . |

Using the Stack. You can use the stack registers to specify a particular matrix element. This eliminates the need to change the numbers in R_0 and R_1 .

- To recall an element value, enter the row number and column number into the stack (in that order). Then press $\boxed{\text{RCL}}$ $\boxed{9}$ followed by the letter key specifying the matrix. The element value is placed in the X-register. (The row and column numbers are lost from the stack.)
- To store an element value, first enter the value into the stack followed by the row number and column number. Then press $\boxed{\text{STO}}$ $\boxed{9}$ followed by the letter key specifying the matrix. (The row and column numbers are lost from the stack; the element value is returned to the X-register.)

Note that these are the only operations in which the blue $\boxed{9}$ key precedes a gold letter key.

Example: Recall the element in row 2, column 1 of matrix **A** from the previous example. Use the stack registers.

| Keystrokes | Display | |
|---|----------------|--|
| 2 ENTER 1 | 1 | Enters row number into Y-register and column number into X-register. |
| RCL g A | 4 . 0000 | |

Value of a_{21} .

Storing a Number in All Elements of a Matrix

To store a number in all elements of a matrix, simply key that number into the display, then press STO MATRIX followed by the letter key specifying the matrix.

Matrix Operations

In many ways, matrix operations are like numeric calculations. Numeric calculations require you to specify the numbers to be used; often you define a register for storing the result. Similarly, matrix calculations require you to specify one or two matrices that you want to use. A matrix *descriptor* is used to specify a particular matrix. For many calculations, you also must specify a matrix for storing the result. This is the *result matrix*.

Because matrix operations usually require many individual calculations, the calculator flashes the **running** display during most matrix operations.

Matrix Descriptors

Earlier in this section you saw that when you press RCL MATRIX followed by a letter key specifying a matrix, the name of the matrix appears at the left of the display and the number of rows followed by the number of columns appears at the right. The matrix name is called the *descriptor* of the matrix. Matrix descriptors can be moved among the stack and data storage registers just like a number—that is, using STO, RCL, ENTER, etc. Whenever a matrix descriptor is displayed in the X-register, the *current* dimensions of that matrix are shown with it.

You use matrix descriptors to indicate which matrices are used in each matrix operation. The matrix operations discussed in the rest of this

section operate on the matrices whose descriptors are placed in the X-register and (for some operations) the Y-register.

Two matrix operations—calculating a determinant and solving the matrix equation $\mathbf{AX} = \mathbf{B}$ —involve calculating an *LU* decomposition (also known as an *LU* factorization) of the matrix specified in the X-register.* A matrix that is an *LU* decomposition is signified by two dashes following the matrix name in the display of its descriptor. (Refer to page 160 for using a matrix in *LU* form.)

The Result Matrix

For many operations discussed in this section, you need to define the matrix in which the result of the operation should be stored. This matrix is called the *result matrix*.

Other matrix operations do *not* use or affect the result matrix. (This is noted in the descriptions of these operations.) Such an operation either replaces the original matrix with the result of the operation (if the result is a matrix, such as a transpose) or returns a number to the X-register (if the result is a number, such as a row norm).

Before you perform an operation that uses the result matrix, you must designate the result matrix. Do this by pressing \boxed{f} $\boxed{\text{RESULT}}$ followed by the letter key specifying the matrix. (If the descriptor of the intended result matrix is already in the X-register, you can press $\boxed{\text{STO}}$ $\boxed{\text{RESULT}}$ instead.) The designated matrix remains the result matrix until another is designated.† To display the descriptor of the result matrix, press $\boxed{\text{RCL}}$ $\boxed{\text{RESULT}}$.

When you perform an operation that affects the result matrix, the matrix is automatically redimensioned to the proper size. If this redimensioning would require more additional elements than there are available in matrix memory (a *maximum* of 64 for all five matrices), then the operation can't be performed. This restriction can often be overcome by designating the result matrix to be one of the matrices being operated on. (However,

* The *LU* decomposition of a matrix \mathbf{A} is another matrix in which is encoded a lower-triangular matrix, \mathbf{L} , and an upper-triangular matrix, \mathbf{U} , whose product \mathbf{LU} equals matrix \mathbf{A} (possibly with some rows interchanged). The *HP 15c Advanced Functions Handbook* discusses *LU* decomposition in detail.

† Matrix \mathbf{A} is *automatically* designated as the result matrix whenever Continuous Memory is reset.

there are certain operations for which the result matrix can *not* be the same one as either of the matrices being operated on—this is noted in the description of these operations.)

While the key used for any matrix operation that stores a result in the result matrix is held down, the descriptor of the result matrix is displayed. If the key is released within about 3 seconds, the operation is performed, and the descriptor of the result matrix is placed in the X-register. If the key is held down longer, the operation is not performed and the calculator displays **null**.

Copying a Matrix

To copy the elements of a matrix into the corresponding elements of another matrix, use the **[STO] [MATRIX]** sequence:

1. Press **[RCL] [MATRIX]** followed by the letter key specifying the matrix to be copied. This enters the descriptor of the matrix into the display.
2. Press **[STO] [MATRIX]** followed by the letter key specifying the matrix to be copied into.

If the matrix specified after **[RCL]** does not have the same dimensions as the matrix specified after **[STO]**, the second matrix is redimensioned to agree with the first. The matrix specified after **[STO]** need not already be dimensioned.

Example: Copy matrix **A** from the previous example into matrix **B**.

| Keystrokes | Display | |
|---------------------------|-----------------|--|
| [RCL] [MATRIX] [A] | A 2 3 | Displays descriptor of matrix to be copied. |
| [STO] [MATRIX] [B] | A 2 3 | Redimensions matrix B and copies A into B . |
| [RCL] [MATRIX] [B] | b 2 3 | Displays descriptor of new matrix B . |

One-Matrix Operations

The following table shows functions that operate on only the matrix specified in the X-register. Operations involving a single matrix plus a number in another stack register are described under Scalar Operations (page 151).

**One-Matrix Operations:
Sign Change, Inverse, Transpose, Norms, Determinant**

| Keystroke(s) | Result in X-register | Effect on Matrix Specified in X-register | Effect on Result Matrix |
|---|---|--|---|
| $\boxed{\text{CHS}}$ | No change. | Changes sign of all elements. | None. [‡] |
| $\boxed{1/x}$ ($\boxed{\text{f}}$ $\boxed{1/x}$ in User Mode) | Descriptor of result matrix. | None. [‡] | Inverse of specified matrix. [§] |
| $\boxed{\text{f}}$ $\boxed{\text{MATRIX}}$ 4 | Descriptor of transpose. | Replaced by transpose. | None. [‡] |
| $\boxed{\text{f}}$ $\boxed{\text{MATRIX}}$ 7 | Row norm of specified matrix.* | None. | None. |
| $\boxed{\text{f}}$ $\boxed{\text{MATRIX}}$ 8 | Frobenius or Euclidean norm of specified matrix. [†] | None. | None. |
| $\boxed{\text{f}}$ $\boxed{\text{MATRIX}}$ 9 | Determinant of specified matrix. | None. [‡] | <i>LU</i> decomposition of specified matrix. [§] |

* The row norm is the largest sum of the absolute values of the elements in each row of the specified matrix.

† The Frobenius or Euclidean norm is the square root of the sum of the squares of all elements in the specified matrix.

‡ Unless the result matrix is the same matrix specified in the X-register.

§ If the specified matrix is a *singular matrix* (that is, one that doesn't have an inverse), then the HP 15c modifies the *LU* form by an amount that is usually small compared to round-off error. For $\boxed{1/x}$, the calculated inverse is the inverse of a matrix close to the original, singular matrix. (Refer to the *HP 15c Advanced Functions Handbook* for further information.)

Example: Calculate the transpose of matrix **B**. Matrix **B** was set in preceding examples to

$$\mathbf{B} = \begin{bmatrix} 1 & 2 & 3 \\ 4 & 5 & 9 \end{bmatrix}.$$

| Keystrokes | Display |
|---|---|
| $\boxed{\text{RCL}}$ $\boxed{\text{MATRIX}}$ $\boxed{\text{B}}$ | b 2 3 Displays descriptor of 2×3 matrix B . |
| $\boxed{\text{f}}$ $\boxed{\text{MATRIX}}$ 4 | b 3 2 Descriptor of 3×2 transpose. |

Matrix **B** (which you can view using $\boxed{\text{RCL}}$ $\boxed{\text{B}}$ in User mode) is now

$$\mathbf{B} = \begin{bmatrix} 1 & 4 \\ 2 & 5 \\ 3 & 9 \end{bmatrix}.$$

Scalar Operations

Scalar operations perform arithmetic operations between a scalar (that is, a number) and each element of a matrix. The scalar and the descriptor of the matrix must be placed in the X- and Y-registers—in either order. (Note that the register position will affect the outcome of the $\boxed{-}$ and $\boxed{\div}$ functions.) The resulting values are stored in the corresponding elements of the result matrix.

The possible operations are shown in the following table.

152 Section 12: Calculating with Matrices

| Operation | Elements of Result Matrix* | |
|------------------|--|---|
| | Matrix in Y-Register Scalar in X-Register | Scalar in Y-Register Matrix in X-Register |
| $\boxed{+}$ | Adds scalar value to each matrix element. | |
| $\boxed{\times}$ | Multiplies each matrix element by scalar value. | |
| $\boxed{-}$ | Subtracts scalar value from each matrix element. | Subtracts each matrix element from scalar value. |
| $\boxed{\div}$ | Divides each matrix element by scalar value. | Calculates inverse of matrix and multiplies each element by scalar value. |

* Result matrix may be the specified matrix.

Example: Calculate the matrix $\mathbf{B} = 2\mathbf{A}$, then subtract 1 from every element in \mathbf{B} . From before, use

$$\mathbf{A} = \begin{bmatrix} 1 & 2 & 3 \\ 4 & 5 & 9 \end{bmatrix}.$$

Keystrokes

Display

\boxed{f} \boxed{RESULT} \boxed{B}

Designates matrix \mathbf{B} as result matrix.

\boxed{RCL} \boxed{MATRIX} \boxed{A}

\mathbf{A} 2 3

Displays descriptor of matrix \mathbf{A} .

2 $\boxed{\times}$

\mathbf{b} 2 3

Redimensions matrix \mathbf{B} to the same dimensions as \mathbf{A} , multiplies the elements of \mathbf{A} by 2, stores those values in the corresponding elements of \mathbf{B} , and displays the descriptor of the result matrix.

| Keystrokes | Display | |
|---------------|---------|---|
| 1 $\boxed{-}$ | b 2 3 | Subtracts 1 from the elements of matrix B and stores those values in the same elements of B . |

The result (which you can view using $\boxed{\text{RCL}} \boxed{\text{B}}$ in User mode) is

$$\mathbf{B} = \begin{bmatrix} 1 & 3 & 5 \\ 7 & 9 & 17 \end{bmatrix}.$$

Arithmetic Operations

With matrix descriptors in both the X- and Y-registers, pressing $\boxed{+}$ or $\boxed{-}$ calculates the sum or difference of the matrices.

| Pressing | Calculates* |
|---|---------------------------|
| $\boxed{+}$ | $\mathbf{Y} + \mathbf{X}$ |
| $\boxed{-}$ | $\mathbf{Y} - \mathbf{X}$ |
| * Result is stored in result matrix. Result matrix may be X or Y . | |

Example: Calculate $\mathbf{C} = \mathbf{B} - \mathbf{A}$, where **A** and **B** are defined in the previous example,

$$\mathbf{A} = \begin{bmatrix} 1 & 2 & 3 \\ 4 & 5 & 9 \end{bmatrix} \quad \text{and} \quad \mathbf{B} = \begin{bmatrix} 1 & 3 & 5 \\ 7 & 9 & 17 \end{bmatrix}.$$

| Keystrokes | Display | |
|---|---------|--|
| $\boxed{\text{f}} \boxed{\text{RESULT}} \boxed{\text{C}}$ | | Designates C as result matrix. |
| $\boxed{\text{RCL}} \boxed{\text{MATRIX}} \boxed{\text{B}}$ | b 2 3 | Recalls descriptor of matrix B . (This step can be skipped if descriptor is already in X-register.) |
| $\boxed{\text{RCL}} \boxed{\text{MATRIX}} \boxed{\text{A}}$ | A 2 3 | Recalls descriptor of matrix A into X-register, moving descriptor of matrix B to Y-register. |

Keystrokes Display



C 2 3

Calculates $\mathbf{B} - \mathbf{A}$ and stores values in redimensioned result matrix \mathbf{C} .

The result is

$$\mathbf{C} = \begin{bmatrix} 0 & 1 & 2 \\ 3 & 4 & 8 \end{bmatrix}$$

Matrix Multiplication

With matrix description in both the X- and Y-registers, you can calculate three different matrix products. The table below shows the results of the three functions for a matrix \mathbf{X} specified in the X-register and a matrix \mathbf{Y} specified in the Y-register. The matrix \mathbf{X}^{-1} is the inverse of \mathbf{X} , and the matrix \mathbf{Y}^T is the transpose of \mathbf{Y} .

| Pressing | Calculates* |
|--|-----------------------------|
| | \mathbf{YX} |
| MATRIX 5 | $\mathbf{Y}^T\mathbf{X}$ |
| | $\mathbf{X}^{-1}\mathbf{Y}$ |
| * Result is stored in result matrix. For , the result matrix can be \mathbf{Y} but not \mathbf{X} . For the others, the result matrix must be other than \mathbf{X} or \mathbf{Y} . | |

Note: When you use the function to evaluate the expression $\mathbf{A}^{-1}\mathbf{B}$, you must enter the matrix descriptors in the order \mathbf{B} , \mathbf{A} rather than in the order that they appear in the expression.*

The value stored in each element of the result matrix is determined according to the usual rules of matrix multiplication.

For 5, the matrix specified in the Y-register isn't changed by this operation, even though its transpose is used. The result is identical to that obtained using 4 (transpose) and .

* This is the same order you would use if you were entering b and a for evaluating $a^{-1}b = b/a$.

For $\boxed{\div}$, the matrix specified in the X-register is replaced by its LU decomposition. The $\boxed{\div}$ function calculates $\mathbf{X}^{-1}\mathbf{Y}$ using a more direct method than does $\boxed{1/x}$ and $\boxed{\times}$, giving the result faster and with improved accuracy.

Example: Using matrices **A** and **B** from the previous example, calculate $\mathbf{C} = \mathbf{A}^T\mathbf{B}$.

$$\mathbf{A} = \begin{bmatrix} 1 & 2 & 3 \\ 4 & 5 & 9 \end{bmatrix} \quad \text{and} \quad \mathbf{B} = \begin{bmatrix} 1 & 3 & 5 \\ 7 & 9 & 17 \end{bmatrix}$$

| Keystrokes | Display | |
|---|-----------------|---|
| $\boxed{\text{RCL}}$ $\boxed{\text{MATRIX}}$ $\boxed{\text{A}}$ | A 2 3 | Recalls descriptor for matrix A . |
| $\boxed{\text{RCL}}$ $\boxed{\text{MATRIX}}$ $\boxed{\text{B}}$ | b 2 3 | Recalls descriptor for matrix B into X-register, moving matrix A descriptor into Y-register. |
| $\boxed{\text{f}}$ $\boxed{\text{RESULT}}$ $\boxed{\text{C}}$ | b 2 3 | Designates matrix C as result matrix. |
| $\boxed{\text{f}}$ $\boxed{\text{MATRIX}}$ 5 | c 3 3 | Calculates $\mathbf{A}^T\mathbf{B}$ and stores result in matrix C , which is redimensioned to 3×3 . |

The result, matrix **C**, is

$$\mathbf{C} = \begin{bmatrix} 29 & 39 & 73 \\ 37 & 51 & 95 \\ 66 & 90 & 168 \end{bmatrix}.$$

Solving the Equation $AX = B$

The $\boxed{\div}$ function is useful for solving matrix equations of the form $AX = B$, where A is the coefficient matrix, B is the constant matrix, and X is the solution matrix. The descriptor of the constant matrix B should be entered in the Y-register and the descriptor of the coefficient matrix A should be entered in the X-register. Pressing $\boxed{\div}$ then calculates the solution $X = A^{-1}B$.*

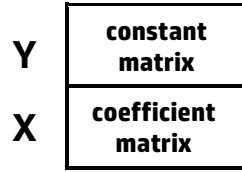

Remember that the $\boxed{\div}$ function replaces the coefficient matrix by its LU decomposition and that this matrix must not be specified as the result matrix. Furthermore, using $\boxed{\div}$ rather than $\boxed{1/x}$ and $\boxed{\times}$ gives a solution faster and with improved accuracy.

At the beginning of this section, you found the solution for a system of linear equations in which the constant matrix and the solution matrix each had one column. The following example illustrates that you can use the HP 15c to find solutions for more than one set of constants—that is, for a constant matrix and solution matrix with more than one column.

Example: Looking at his receipts for his last three deliveries of cabbage and broccoli, Silas Farmer sees the following summary.



* If A is a *singular* matrix (that is, one that doesn't have an inverse), then the HP 15c modifies the LU form of A by an amount that is usually small compared to round-off error. The calculated solution corresponds to that for a nonsingular coefficient matrix close to the original, singular matrix.

| | Week | | |
|--------------------------|----------|----------|----------|
| | 1 | 2 | 3 |
| Total Weight (kg) | 274 | 233 | 331 |
| Total Value | \$120.32 | \$112.96 | \$151.36 |

Silas knows that he received \$0.24 per kilogram for his cabbage and \$0.86 per kilogram for his broccoli. Use matrix operations to determine the weights of cabbage and broccoli he delivered each week.

Solution: Each week's delivery represents two linear equations (one for weight and one for value) with two unknown variables (the weights of cabbage and broccoli). All three weeks can be handled simultaneously using the matrix equation

$$\begin{bmatrix} 1 & 1 \\ 0.24 & 0.86 \end{bmatrix} \begin{bmatrix} d_{11} & d_{12} & d_{13} \\ d_{21} & d_{22} & d_{23} \end{bmatrix} = \begin{bmatrix} 274 & 233 & 331 \\ 120.32 & 112.96 & 151.36 \end{bmatrix}$$

or $\mathbf{AD} = \mathbf{B}$

where the first row of matrix **D** is the weights of cabbage for the three weeks and the second row is the weights of broccoli.

Keystrokes

2 [ENTER] [f] [DIM] [A]

[f] [MATRIX] 1

[f] [USER]

1 [STO] [A]

[STO] [A]

.24 [STO] [A]

.86 [STO] [A]

2 [ENTER] 3 [f] [DIM] [B]

Display

2.0000 Dimensions **A** as 2×2 matrix.

2.0000 Sets row and column numbers in R_0 and R_1 to 1.

2.0000 Activates User mode.

1.0000 Stores a_{11} .

1.0000 Stores a_{12} .

0.2400 Stores a_{21} .

0.8600 Stores a_{22} .

3.0000 Dimensions **B** as 2×3 matrix.

158 Section 12: Calculating with Matrices

| Keystrokes | Display | |
|-----------------------------------|-----------------|---|
| 274 STO B | 274 . 0000 | Stores b_{11} .* |
| 233 STO B | 233 . 0000 | Stores b_{12} . |
| 331 STO B | 331 . 0000 | Stores b_{13} . |
| 120.32 STO B | 120 . 3200 | Stores b_{21} . |
| 112.96 STO B | 112 . 9600 | Stores b_{22} . |
| 151.36 STO B | 151 . 3600 | Stores b_{23} . |
| f RESULT D | 151 . 3600 | Designates matrix D as result matrix. |
| RCL MATRIX B | b 2 3 | Recalls descriptor of constant matrix. |
| RCL MATRIX A | A 2 2 | Recalls descriptor of coefficient matrix A into X-register, moving descriptor of constant matrix B into Y-register. |
| ÷ | d 2 3 | Calculates $\mathbf{A}^{-1}\mathbf{B}$ and stores result in matrix D . |
| RCL D | 186 . 0000 | Recalls d_{11} , the weight of cabbage for the first week. |
| RCL D | 141 . 0000 | Recalls d_{12} the weight of cabbage for the second week. |
| RCL D | 215 . 0000 | Recalls d_{13} . |
| RCL D | 88 . 0000 | Recalls d_{21} . |
| RCL D | 92 . 0000 | Recalls d_{22} . |
| RCL D | 116 . 0000 | Recalls d_{23} . |
| f USER | 116 . 0000 | Deactivates User mode. |

* Note that you did not need to press **f** **MATRIX** 1 before beginning to store the elements of matrix **B**. This is because after you stored the last element of matrix **A**, the row and column numbers in R_0 and R_1 were automatically reset to 1.

Silas' deliveries were:

| | Week | | |
|----------------------|------|-----|-----|
| | 1 | 2 | 3 |
| Cabbage (kg) | 186 | 141 | 215 |
| Broccoli (kg) | 88 | 92 | 116 |

Calculating the Residual

The HP 15c enables you to calculate the residual, that is, the matrix

$$\text{Residual} = \mathbf{R} - \mathbf{YX}$$

where **R** is the result matrix and **X** and **Y** are the matrices specified in the X- and Y-registers.

This capability is useful, for example, in doing iterative refinement on the solution of a system of equations and for linear regression problems. For example, if **C** is a possible solution for $\mathbf{AX} = \mathbf{B}$, then $\mathbf{B} - \mathbf{AC}$ indicates how well this solution satisfies the equation. (Refer to the *HP 15c Advanced Functions Handbook* for information about iterative refinement and linear regression.)

The residual function (**MATRIX** 6) uses the current contents of the result matrix and the matrices specified in the X- and Y-registers to calculate the residual defined above. The residual is stored in the result matrix, replacing the original result matrix. A matrix specified in the X- or Y-register can not be the result matrix.

Using **MATRIX** 6 rather than **×** and **−** gives a result with improved accuracy, particularly if the residual is small compared to the matrices being subtracted.

To calculate the residual:

1. Enter the descriptor of the **Y** matrix into the Y-register.
2. Enter the descriptor of the **X** matrix into the X-register,
3. Designate the **R** matrix as the result matrix.
4. Press **f** **MATRIX** 6. The residual replaces the original result matrix (**R**). The descriptor of the result matrix is placed in the X-register.

Using Matrices in *LU* Form

As noted earlier, two matrix operations (calculating a determinant and solving the matrix equation $\mathbf{AX} = \mathbf{B}$) create an *LU* decomposition of the matrix specified in the X-register. The descriptor of such a matrix has two dashes following the matrix name. A matrix in *LU* form has elements that differ from the elements of the original matrix.

However, the descriptor for a matrix in *LU* form can be used in place of the descriptor for the original matrix for operations involving the inverse of the matrix and for the determinant operation. That is, either the original matrix or its *LU* decomposition can be used for these operations:

$1/x$

\div for the matrix in the X-register

MATRIX 9

For these three functions, using the *LU* form of the matrix to be inverted gives a result that is identical to that using the original matrix.

As an example, if you solved the matrix equation $\mathbf{AX} = \mathbf{B}$, matrix **A** would be changed to its *LU* form. If you wanted to change the **B** matrix and solve the equation again, you could do so *without* changing the **A** matrix—the *LU* matrix will give the correct solution.

For all other matrix operations, a matrix that is an *LU* decomposition is *not* recognized as representing its original matrix. Instead, the elements of the *LU* matrix are used just as they appear in matrix memory and the result is not the result you would obtain using the original matrix.

Calculations With Complex Matrices

The HP 15c enables you to perform matrix multiplication and matrix inversion with complex matrices (that is, matrices whose elements are complex numbers) and to solve systems of complex equations (that is, equations whose coefficients and variables are complex).

However, the HP 15c stores and operates on only real matrices. The capability of doing calculations with complex matrices is completely independent of the capability of doing calculations with complex numbers

described in the preceding section. *You don't need to activate Complex mode for calculations with complex matrices.*

Instead, calculations with complex matrices are performed by using real matrices derived from the original complex matrices—in a manner to be described below—and performing certain transformations in addition to the regular matrix operations. These transformations are performed by four calculator functions. This section will describe how to do these calculations. (There are more examples of calculations with complex matrices in the *HP 15c Advanced Functions Handbook*.)

Storing the Elements of a Complex Matrix

Consider an $m \times n$ complex matrix $\mathbf{Z} = \mathbf{X} + i\mathbf{Y}$, where \mathbf{X} and \mathbf{Y} are real $m \times n$ matrices. This matrix can be represented in the calculator as a $2m \times n$ “partitioned” matrix:

$$\mathbf{Z}^P = \left[\begin{array}{c} \mathbf{X} \\ \mathbf{Y} \end{array} \right] \begin{array}{l} \} \text{ Real Part} \\ \} \text{ Imaginary Part} \end{array}$$

The superscript P signifies that the complex matrix is represented by a partitioned matrix.

All of the elements of \mathbf{Z}^P are real numbers—those in the upper half represent the elements of the real part (matrix \mathbf{X}), those in the lower half represent the elements of the imaginary part (matrix \mathbf{Y}). The elements of \mathbf{Z}^P are stored in one of the five matrices (\mathbf{A} , for example) in the usual manner, as described earlier in this section.

For example, if $\mathbf{Z} = \mathbf{X} + i\mathbf{Y}$, where

$$\mathbf{X} = \begin{bmatrix} x_{11} & x_{12} \\ x_{21} & x_{22} \end{bmatrix} \quad \text{and} \quad \mathbf{Y} = \begin{bmatrix} y_{11} & y_{12} \\ y_{21} & y_{22} \end{bmatrix},$$

162 Section 12: Calculating with Matrices

then \mathbf{Z} can be represented in the calculator by

$$\mathbf{A} = \mathbf{Z}^P = \begin{bmatrix} \mathbf{X} \\ \mathbf{Y} \end{bmatrix} = \begin{bmatrix} x_{11} & x_{12} \\ x_{21} & x_{22} \\ \hline y_{11} & y_{12} \\ y_{21} & y_{22} \end{bmatrix}.$$

Suppose you need to do a calculation with a complex matrix that is not written as the sum of a real matrix and an imaginary matrix—as was the matrix \mathbf{Z} in the example above—but rather written with an entire complex number in each element, such as

$$\mathbf{Z} = \begin{bmatrix} x_{11} + iy_{11} & x_{12} + iy_{12} \\ x_{21} + iy_{21} & x_{22} + iy_{22} \end{bmatrix}.$$

This matrix can be represented in the calculator by a real matrix that looks very similar—one that is derived simply by ignoring the i and the $+$ sign. The 2×2 matrix \mathbf{Z} shown above, for example, can be represented in the calculator in “complex” form by the 2×4 matrix.

$$\mathbf{A} = \mathbf{Z}^C = \begin{bmatrix} x_{11} & y_{11} & x_{12} & y_{12} \\ x_{21} & y_{21} & x_{22} & y_{22} \end{bmatrix}.$$

The superscript C signifies that the complex matrix is represented in a “complex-like” form.

Although a complex matrix can be *initially* represented in the calculator by a matrix of the form shown for \mathbf{Z}^C , the transformations used for multiplying and inverting a complex matrix presume that the matrix is represented by a matrix of the form shown for \mathbf{Z}^P . The HP 15c provides two transformations that convert the representation of a complex matrix between \mathbf{Z}^C and \mathbf{Z}^P :

| Pressing | Transforms | Into |
|----------------------------|----------------|----------------|
| \boxed{f} $\boxed{Py,x}$ | \mathbf{Z}^C | \mathbf{Z}^P |
| \boxed{g} $\boxed{Cy,x}$ | \mathbf{Z}^P | \mathbf{Z}^C |

To do either of these transformations, recall the descriptor of \mathbf{Z}^C or \mathbf{Z}^P into the display, then press the keys shown above. The transformation is done to the specified matrix; the result matrix is not affected.

Example: Store the complex matrix

$$\mathbf{Z} = \begin{bmatrix} 4 + 3i & 7 - 2i \\ 1 + 5i & 3 + 8i \end{bmatrix}$$

in the form \mathbf{Z}^C , since it is written in a form that shows \mathbf{Z}^C . Then transform \mathbf{Z}^C into the form \mathbf{Z}^P .

You can do this by storing the elements of \mathbf{Z}^C in matrix **A** and then using the $\text{P}_{y,x}$ function, where

$$\mathbf{A} = \mathbf{Z}^C = \begin{bmatrix} 4 & 3 & 7 & -2 \\ 1 & 5 & 3 & 8 \end{bmatrix}.$$

Keystrokes

f **MATRIX** 0

2 **ENTER** 4 f **DIM** **A**

f **MATRIX** 1

f **USER**

4 **STO** **A**

3 **STO** **A**

7 **STO** **A**

2 **CHS** **STO** **A**

1 **STO** **A**

5 **STO** **A**

3 **STO** **A**

8 **STO** **A**

f **USER**

RCL **MATRIX** **A**

f $\text{P}_{y,x}$

Display

4 . 0000

4 . 0000

4 . 0000

4 . 0000

3 . 0000

7 . 0000

-2 . 0000

1 . 0000

5 . 0000

3 . 0000

8 . 0000

8 0000

A 2 4

A 4 2

Clears all matrices.

Dimensions matrix **A** to be 2×4 .

Sets beginning row and column numbers in R_0 and R_1 to 1.

Activates User mode.

Stores a_{11} .

Stores a_{12} .

Stores a_{13} .

Stores a_{14} .

Stores a_{21} .

Stores a_{22} .

Stores a_{23} .

Stores a_{24} .

Deactivates User mode.

Display descriptor of matrix **A**.

Transforms \mathbf{Z}^C into \mathbf{Z}^P and redimensions matrix **A**.

164 Section 12: Calculating with Matrices

Matrix **A** now represents the complex matrix **Z** in \mathbf{Z}^P form:

$$\mathbf{A} = \mathbf{Z}^P = \left[\begin{array}{cc|cc} 4 & 7 & & \\ 1 & 3 & & \\ \hline 3 & -2 & & \\ 5 & 8 & & \end{array} \right]. \quad \left. \begin{array}{l} \text{Real Part} \\ \text{Imaginary Part} \end{array} \right\}$$

The Complex Transformations Between \mathbf{Z}^P and $\tilde{\mathbf{Z}}$

An additional transformation must be done when you want to calculate the product of two complex matrices, and still another when you want to calculate the inverse of a complex matrix. These transformations convert between the \mathbf{Z}^P representation of an $m \times n$ complex matrix and a $2m \times 2n$ partitioned matrix of the following form:

$$\tilde{\mathbf{Z}} = \begin{bmatrix} \mathbf{X} & -\mathbf{Y} \\ \mathbf{Y} & \mathbf{X} \end{bmatrix}.$$

The matrix $\tilde{\mathbf{Z}}$ created by the **MATRIX** 2 transformation has twice as many elements as \mathbf{Z}^P .

For example, the matrices below show how $\tilde{\mathbf{Z}}$ is related to \mathbf{Z}^P .

$$\mathbf{Z}^P = \left[\begin{array}{cc|cc} 1 & -6 & & \\ \hline -4 & 5 & & \end{array} \right] \leftrightarrow \tilde{\mathbf{Z}} = \left[\begin{array}{cc|cc} 1 & -6 & 4 & -5 \\ \hline -4 & 5 & 1 & -6 \end{array} \right].$$

The transformations that convert the representation of a complex matrix between \mathbf{Z}^P and $\tilde{\mathbf{Z}}$ are shown in the following table.

| Pressing | Transforms | Into |
|--------------------------|----------------------|----------------------|
| f MATRIX 2 | \mathbf{Z}^P | $\tilde{\mathbf{Z}}$ |
| f MATRIX 3 | $\tilde{\mathbf{Z}}$ | \mathbf{Z}^P |

To do either of these transformations, recall the descriptor of \mathbf{Z}^P or $\tilde{\mathbf{Z}}$ into the display, then press the keys shown above. The transformation is done to the specified matrix; the result matrix is not affected.

Inverting a Complex Matrix

You can calculate the inverse of a complex matrix by using the fact that $(\tilde{\mathbf{Z}})^{-1} = (\mathbf{Z}^{-1})$.

To calculate the inverse, \mathbf{Z}^{-1} , of a complex matrix \mathbf{Z} :

1. Store the elements of \mathbf{Z} in memory, in the form either of \mathbf{Z}^P or of \mathbf{Z}^C .
2. Recall the descriptor of the matrix representing \mathbf{Z} into the display.
3. If the elements of \mathbf{Z} were entered in the form \mathbf{Z}^C , press $\boxed{f} \boxed{Py,x}$ to transform \mathbf{Z}^C into \mathbf{Z}^P .
4. Press $\boxed{f} \boxed{MATRIX} 2$ to transform \mathbf{Z}^P into $\tilde{\mathbf{Z}}$.
5. Designate a matrix as the result matrix. It may be the same as the matrix in which $\tilde{\mathbf{Z}}$ is stored.
6. Press $\boxed{1/x}$. This calculates $(\tilde{\mathbf{Z}})^{-1}$, which is equal to (\mathbf{Z}^{-1}) . The values of these matrix elements are stored in the result matrix, and the descriptor of the result matrix is placed in the X-register.
7. Press $\boxed{f} \boxed{MATRIX} 3$ to transform $(\tilde{\mathbf{Z}}^{-1})$ into $(\mathbf{Z}^{-1})^P$.
8. If you want the inverse in the form $(\mathbf{Z}^{-1})^C$, press $\boxed{g} \boxed{Cy,x}$.

You can derive the complex elements of \mathbf{Z}^{-1} by recalling the elements of \mathbf{Z}^P or \mathbf{Z}^C and then combining them as described earlier.

Example: Calculate the inverse of the complex matrix \mathbf{Z} from the previous example,

$$\mathbf{A} = \mathbf{Z}^P = \begin{bmatrix} 4 & 7 \\ 1 & 3 \\ \hline 3 & -2 \\ 5 & 8 \end{bmatrix}$$

Keystrokes

$\boxed{RCL} \boxed{MATRIX} \boxed{A}$
 $\boxed{f} \boxed{MATRIX} 2$

Display

A 4 2 Recalls descriptor of matrix **A**.
A 4 4 Transforms \mathbf{Z}^P into $\tilde{\mathbf{Z}}$ and redimensions matrix **A**.

166 Section 12: Calculating with Matrices

Keystrokes

\boxed{f} \boxed{RESULT} \boxed{B}

$\boxed{1/x}$

\boxed{f} \boxed{MATRIX} 3

Display

| | | | |
|----------|---|---|---|
| A | 4 | 4 | Designates B as the result matrix. |
| b | 4 | 4 | Calculates $(\tilde{\mathbf{Z}})^{-1} = (\tilde{\mathbf{Z}}^{-1})$ and places the result in matrix B . |
| b | 4 | 2 | Transforms $(\tilde{\mathbf{Z}}^{-1})$ into $(\mathbf{Z}^{-1})^P$. |

The representation of \mathbf{Z}^{-1} in partitioned form is contained in matrix **B**.

$$\mathbf{B} = \begin{bmatrix} -0.0254 & 0.2420 \\ -0.0122 & -0.1017 \\ \hline -0.2829 & -0.0022 \\ 0.1691 & -0.1315 \end{bmatrix} \begin{array}{l} \left. \vphantom{\begin{matrix} -0.0254 \\ -0.0122 \end{matrix}} \right\} \text{Real Part} \\ \left. \vphantom{\begin{matrix} -0.2829 \\ 0.1691 \end{matrix}} \right\} \text{Imaginary Part} \end{array}$$

Multiplying Complex Matrices

The product of two complex matrices can be calculated by using the fact that $(\mathbf{YX})^P = \tilde{\mathbf{Y}}\mathbf{X}^P$.

To calculate \mathbf{YX} , where **Y** and **X** are complex matrices:

1. Store the elements of **Y** and **X** in memory, in the form either of \mathbf{Z}^P or \mathbf{Z}^C .
2. Recall the descriptor of the matrix representing **Y** into the display.
3. If the elements of **Y** were entered in the form of \mathbf{Y}^C , press \boxed{f} $\boxed{Py,x}$ to transform \mathbf{Y}^C into \mathbf{Y}^P .
4. Press \boxed{f} \boxed{MATRIX} 2 to transform \mathbf{Y}^P into $\tilde{\mathbf{Y}}$.
5. Recall the descriptor of the matrix representing **X** into the display.
6. If the elements of **X** were entered in the form \mathbf{X}^C , press \boxed{f} $\boxed{Py,x}$ to transform \mathbf{X}^C into \mathbf{X}^P .
7. Designate the result matrix; it must not be the same matrix as either of the other two.

8. Press $\boxed{\times}$ to calculate $\tilde{\mathbf{Y}}\mathbf{X}^P = (\mathbf{Y}\mathbf{X})^P$. The values of these matrix elements are placed in the result matrix, and the descriptor of the result matrix is placed in the X-register.
9. If you want the product in the form $(\mathbf{Y}\mathbf{X})^C$, press \boxed{g} $\boxed{C_{y,x}}$.

Note that you don't transform \mathbf{X}^P into $\tilde{\mathbf{X}}$.

You can derive the complex elements of the matrix product $\mathbf{Y}\mathbf{X}$ by recalling the elements of $(\mathbf{X}\mathbf{Y})^P$ or $(\mathbf{Y}\mathbf{X})^C$ and combining them according to the conventions described earlier.

Example: Calculate the product $\mathbf{Z}\mathbf{Z}^{-1}$, where \mathbf{Z} is the complex matrix given in the preceding example.

Since elements representing both matrices are already stored ($\tilde{\mathbf{Z}}$ in **A** and $(\mathbf{Z}^{-1})^P$ in **B**), skip steps 1, 3, 4, and 6.

| Keystrokes | Display | | |
|--|---------|-------------|---|
| \boxed{RCL} \boxed{MATRIX} \boxed{A} | A | 4 4 | Displays descriptor of matrix A . |
| \boxed{RCL} \boxed{MATRIX} \boxed{B} | b | 4 2 | Displays descriptor of matrix B . |
| \boxed{f} \boxed{RESULT} \boxed{C} | b | 4 2 | Designates C as result matrix. |
| $\boxed{\times}$ | C | 4 2 | Calculates $\tilde{\mathbf{Z}}(\mathbf{Z}^{-1})^P = (\mathbf{Z}\mathbf{Z}^{-1})^P$. |
| \boxed{f} \boxed{USER} | C | 4 2 | Activates User mode. |
| \boxed{RCL} \boxed{C} | C | 1, 1 | Matrix C , row 1, column 1. (Displayed momentarily while last key held down.) |
| | | 1.0000 | Value of c_{11} . |
| \boxed{RCL} \boxed{C} | | -2.8500 -10 | Value of c_{12} . |
| \boxed{RCL} \boxed{C} | | -4.0000 -11 | Value of c_{21} . |
| \boxed{RCL} \boxed{C} | | 1.0000 | Value of c_{22} . |
| \boxed{RCL} \boxed{C} | | 1.0000 -11 | Value of c_{31} . |
| \boxed{RCL} \boxed{C} | | 3.8000 -10 | Value of c_{32} . |
| \boxed{RCL} \boxed{C} | | 1.0000 -11 | Value of c_{41} . |
| \boxed{RCL} \boxed{C} | | -1.0500 -10 | Value of c_{42} . |
| \boxed{f} \boxed{USER} | | -1.0500 -10 | Deactivates User mode. |

168 Section 12: Calculating with Matrices

Writing down the elements of \mathbf{C} ,

$$\mathbf{C} = \begin{bmatrix} 1.000 & -2.8500 \times 10^{-10} \\ -4.0000 \times 10^{-11} & 1.0000 \\ 1.0000 \times 10^{-11} & 3.8000 \times 10^{-10} \\ 1.0000 \times 10^{-11} & -1.0500 \times 10^{-10} \end{bmatrix} = (\mathbf{ZZ}^{-1})^P,$$

where the upper half of matrix \mathbf{C} is the real part of \mathbf{ZZ}^{-1} and the lower half is the imaginary part. Therefore, by inspection of matrix \mathbf{C} ,

$$\begin{aligned} \mathbf{ZZ}^{-1} &= \begin{bmatrix} 1.000 & -2.8500 \times 10^{-10} \\ -4.0000 \times 10^{-11} & 1.0000 \end{bmatrix} \\ &+ i \begin{bmatrix} 1.0000 \times 10^{-11} & 3.8000 \times 10^{-10} \\ 1.0000 \times 10^{-11} & -1.0500 \times 10^{-10} \end{bmatrix} \end{aligned}$$

As expected,

$$\mathbf{ZZ}^{-1} \approx \begin{bmatrix} 1 & 0 \\ 0 & 1 \end{bmatrix} + i \begin{bmatrix} 0 & 0 \\ 0 & 0 \end{bmatrix}.$$

Solving the Complex Equation $\mathbf{AX} = \mathbf{B}$

You can solve the complex matrix equation $\mathbf{AX} = \mathbf{B}$ by finding $\mathbf{X} = \mathbf{A}^{-1}\mathbf{B}$. Do this by calculating $\mathbf{X}^P = (\tilde{\mathbf{A}})^{-1}\mathbf{B}^P$.

To solve the equation $\mathbf{AX} = \mathbf{B}$, where \mathbf{A} , \mathbf{X} , and \mathbf{B} are complex matrices:

1. Store the elements of \mathbf{A} and \mathbf{B} in memory, in the form either of \mathbf{Z}^P or of \mathbf{Z}^C .
2. Recall the descriptor of the matrix representing \mathbf{B} into the display.
3. If the elements of \mathbf{B} were entered in the form \mathbf{B}^C , press $\boxed{\text{f}} \boxed{\text{Py,x}}$ to transform \mathbf{B}^C into \mathbf{B}^P .
4. Recall the descriptor of the matrix representing \mathbf{A} into the display.
5. If the elements of \mathbf{A} were entered in the form of \mathbf{A}^C , press $\boxed{\text{f}} \boxed{\text{Py,x}}$ to transform \mathbf{A}^C into \mathbf{A}^P .

6. Press \boxed{f} $\boxed{\text{MATRIX}}$ 2 to transform \mathbf{A}^P into $\tilde{\mathbf{A}}$.
7. Designate the result matrix; it must not be the same as the matrix representing \mathbf{A} .
8. Press $\boxed{\div}$; this calculates \mathbf{X}^P . The values of these matrix elements are placed in the result matrix, and the descriptor of the result matrix is placed in the X-register.
9. If you want the solution in the form \mathbf{X}^C , press \boxed{g} $\boxed{\text{Cy,x}}$.

Note that you don't transform \mathbf{B}^P into $\tilde{\mathbf{B}}$.

You can derive the complex elements of the solution \mathbf{X} by recalling the elements of \mathbf{X}^P or \mathbf{X}^C and combining them according to the conventions described earlier.

Example: Engineering student A. C. Dimmer wants to analyze the electrical circuit shown below. The impedances of the components are indicated in complex form. Determine the complex representation of the currents I_1 and I_2 .

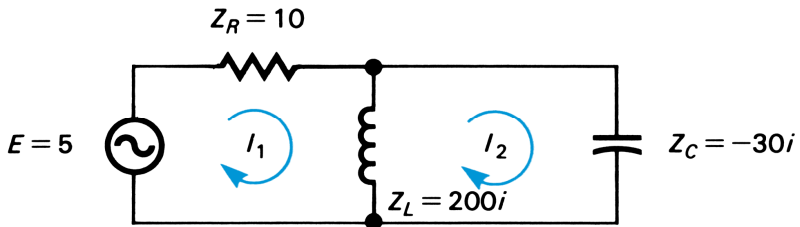

This system can be represented by the complex matrix equation

$$\begin{bmatrix} 10 + 200i & -200i \\ -200i & (200 - 30)i \end{bmatrix} \begin{bmatrix} I_1 \\ I_2 \end{bmatrix} = \begin{bmatrix} 5 \\ 0 \end{bmatrix}$$

or

$$\mathbf{AX} = \mathbf{B}.$$

170 Section 12: Calculating with Matrices

In partitioned form,

$$\mathbf{A} = \begin{bmatrix} 10 & 0 \\ 0 & 0 \\ 200 & -200 \\ -200 & 170 \end{bmatrix} \quad \text{and} \quad \mathbf{B} = \begin{bmatrix} 5 \\ 0 \\ 0 \\ 0 \end{bmatrix},$$

where the zero elements correspond to real and imaginary parts with zero value.

Keystrokes

4 [ENTER] 2 [f] [DIM] [A]

[f] [MATRIX] 1

[f] [USER]

10 [STO] [A]

0 [STO] [A]

[STO] [A]

[STO] [A]

200 [STO] [A]

[CHS] [STO] [A]

[STO] [A]

170 [STO] [A]

4 [ENTER] 1 [f] [DIM] [B]

0 [STO] [MATRIX] [B]

5 [ENTER] 1 [ENTER]

[STO] [g] [B]

[RCL] [MATRIX] [B]

[RCL] [MATRIX] [A]

Display

2 . 0000

2 . 0000

2 . 0000

10 . 0000

0 . 0000

0 . 0000

0 . 0000

200 . 0000

-200 . 0000

-200 . 0000

170 . 0000

1 . 0000

0 . 0000

1 . 0000

5 . 0000

b 4 1

A 4 2

Dimensions matrix **A** to be 4×2 .

Set beginning row and column numbers in R_0 and R_1 to 1.

Activates User mode.

Stores a_{11} .

Stores a_{12} .

Stores a_{21} .

Stores a_{22} .

Stores a_{31} .

Stores a_{32} .

Stores a_{41} .

Stores a_{42} .

Dimensions matrix **B** to be 4×1 .

Stores value 0 in all elements of **B**.

Specifies value 5 for row 1, column 1.

Stores value 5 in b_{11} .

Recalls descriptor for matrix **B**.

Places descriptor for matrix **A** into X-register, moving descriptor for matrix **B** into Y-register.

Keystrokes

f MATRIX 2

f RESULT C

÷

g Cy,x

RCL C

RCL C

RCL C

RCL C

f USER

f MATRIX 0

Display

A 4 4

A 4 4

C 4 1

C 2 2

0.0372

0.1311

0.0437

0.1543

0.1543

0.1543

Transforms \mathbf{A}^P into $\tilde{\mathbf{A}}$.Designates matrix \mathbf{C} as result matrix.Calculates \mathbf{X}^P and stores in \mathbf{C} .Transforms \mathbf{X}^P into \mathbf{X}^C .Recalls c_{11} .Recalls c_{12} .Recalls c_{21} .Recalls c_{22} .

Deactivates User mode.

Redimensions all matrices to 0×0 .

The currents, represented by the complex matrix \mathbf{X} , can be derived from \mathbf{C} :

$$\mathbf{X} = \begin{bmatrix} I_1 \\ I_2 \end{bmatrix} = \begin{bmatrix} 0.0372 + 0.1311i \\ 0.0437 + 0.1543i \end{bmatrix}.$$

Solving the matrix equation in the preceding example required 24 registers of matrix memory—16 for the 4×4 matrix \mathbf{A} (which was originally entered as a 4×2 matrix representing a 2×2 complex matrix), and four each for the matrices \mathbf{B} and \mathbf{C} (each representing a 2×1 complex matrix). (However, you would have used four fewer registers if the result matrix were matrix \mathbf{B} .) Note that since \mathbf{X} and \mathbf{B} are not restricted to be vectors (that is, single-column matrices), \mathbf{X} and \mathbf{B} could have required more memory.

The HP 15c contains sufficient memory to solve, using the method described above, the complex matrix equation $\mathbf{AX} = \mathbf{B}$ with \mathbf{X} and \mathbf{B} having up to six columns if \mathbf{A} is 2×2 , or up to two columns if \mathbf{A} is 3×3 .^{*} (The allowable number of columns doubles if the constant matrix \mathbf{B} is used as the result matrix.) If \mathbf{X} and \mathbf{B} have more columns, or if \mathbf{A} is 4×4 , you can solve the equation using the alternate method below. This method differs from the preceding one in that it involves separate inversion and multiplication operations and fewer registers.

^{*} If sufficient memory space is dimensioned to the common pool (MEM: 33 64 00-0 or more). Refer to Appendix C, Memory Allocation.

172 Section 12: Calculating with Matrices

1. Store the elements of \mathbf{A} in memory, in the form either of \mathbf{A}^P or of \mathbf{A}^C .
2. Recall the descriptor of the matrix representing \mathbf{A} into the display.
3. If the elements of \mathbf{A} were entered in the form \mathbf{A}^C , press \boxed{f} $\boxed{Py,x}$ to transform \mathbf{A}^C into \mathbf{A}^P .
4. Press \boxed{f} \boxed{MATRIX} 2 to transform \mathbf{A}^P into $\tilde{\mathbf{A}}$.
5. Press \boxed{STO} \boxed{RESULT} to designate the matrix representing \mathbf{A} as the result matrix.
6. Press $\boxed{1/x}$ to calculate $(\tilde{\mathbf{A}})^{-1}$.
7. Redimension \mathbf{A} to have half the number of rows as indicated in the display of its descriptor after the preceding step.
8. Store the elements of \mathbf{B} in memory, in the form either of \mathbf{B}^P or of \mathbf{B}^C .
9. Recall the descriptor of the matrix representing \mathbf{A} into the display.
10. Recall the descriptor of the matrix representing \mathbf{B} into the display.
11. If the elements of \mathbf{B} were entered in the form \mathbf{B}^C , press \boxed{f} $\boxed{Py,x}$ to transform \mathbf{B}^C into \mathbf{B}^P .
12. Press \boxed{f} \boxed{MATRIX} 2 to transform \mathbf{B}^P into $\tilde{\mathbf{B}}$.
13. Designate the result matrix; it must not be the same matrix as either of the other two.
14. Press $\boxed{\times}$.
15. Press \boxed{f} \boxed{MATRIX} 4 to transpose the result matrix.
16. Press \boxed{f} \boxed{MATRIX} 2.
17. Redimension the result matrix to have half the number of rows as indicated in the display of its descriptor after the preceding step.
18. Press \boxed{RCL} \boxed{RESULT} to recall the descriptor of the result matrix.
19. Press \boxed{f} \boxed{MATRIX} 4 to calculate \mathbf{X}^P .
20. If you want the solution in the form \mathbf{X}^C , press \boxed{g} $\boxed{Cy,x}$.

A problem using this procedure is given in the *HP 15c Advanced Functions Handbook* under Solving a Large System of Complex Equations.

Miscellaneous Operations Involving Matrices

Using a Matrix Element With Register Operations

If a letter key specifying a matrix is pressed after any of the following function keys, the operation is performed using the matrix element specified by the row and column numbers in R_0 and R_1 , just as though it were a data storage register.

| | |
|--|--|
| $\boxed{\text{STO}}^*$ | $\boxed{\text{RCL}}^*$ |
| $\boxed{\text{STO}}\{ \boxed{+}, \boxed{-}, \boxed{\times}, \boxed{\div} \}$ | $\boxed{\text{RCL}}\{ \boxed{+}, \boxed{-}, \boxed{\times}, \boxed{\div} \}$ |
| $\boxed{\text{DSE}}$ | $\boxed{\text{ISG}}$ |
| $\boxed{x \rightrightarrows}$ | |

Using Matrix Descriptors in the Index Register

In certain applications, you may want to perform a programmed sequence of matrix operations using any of the matrices **A** through **E**. In this situation, the matrix operations can refer to whatever matrix descriptor is stored in the Index register (R_i).

If the Index register contains a matrix descriptor:

- Pressing $\boxed{(i)}$ after any of the functions listed above performs the operation using the element specified by R_0 and R_1 and the matrix specified in R_i .
- Pressing $\boxed{(i)}$ after $\boxed{\text{STO}} \boxed{g}$ or $\boxed{\text{RCL}} \boxed{g}$ performs the operation using the element specified by the row and column numbers in the Y- and X-registers and the matrix specified in R_i .
- Pressing $\boxed{f} \boxed{\text{DIM}} \boxed{I}$ dimensions the matrix specified in R_i according to the dimensions in the X- and Y-registers.
- Pressing $\boxed{\text{RCL}} \boxed{\text{DIM}} \boxed{I}$ recalls to the X- and Y-registers the dimensions of the matrix specified in R_i .
- Pressing $\boxed{\text{GSB}} \boxed{I}$ or $\boxed{\text{GTO}} \boxed{I}$ has the same result as pressing $\boxed{\text{GSB}}$ or $\boxed{\text{GTO}}$ followed by the letter of the matrix specified in R_i . (This is not actually a matrix operation—only the letter in the matrix descriptor is used.)

* Also, in $\boxed{\text{USER}}$ mode the row and column numbers in R_0 and R_1 are incremented according to the dimensions of the specified matrix.

Conditional Tests on Matrix Descriptors

Four conditional tests—`x=0`, `TEST 0` ($x \neq 0$), `TEST 5` ($x = y$), and `TEST 6` ($x \neq y$)—can be performed with matrix descriptors in the X- and Y-registers. Conditional tests can be used to control program execution, as described in Section 8.

If a matrix descriptor is in the X-register, the result of `x=0` will be false and the result of `TEST 0` will be true (regardless of the element values in the matrix.)

If matrix descriptors are in the X- and Y-registers when `TEST 5` or `TEST 6` conditional test is performed, x and y are equal if the same descriptor is in the X- and Y-registers, and not equal otherwise. The comparison is made *between the descriptors themselves, not between the elements* of the specified matrices.

Other conditional tests can't be used with matrix descriptors.

Stack Operation for Matrix Calculations

During matrix calculations, the contents of the stack registers shift much like they do during numeric calculations.

For some matrix calculations, the result is stored in the result matrix. The arguments—one or two descriptors or numbers in the X-register or the X- and Y-registers—are combined by the operation, and the descriptor of the result matrix is placed in the X-register. (The argument from the X-register is placed in the LAST X register.)

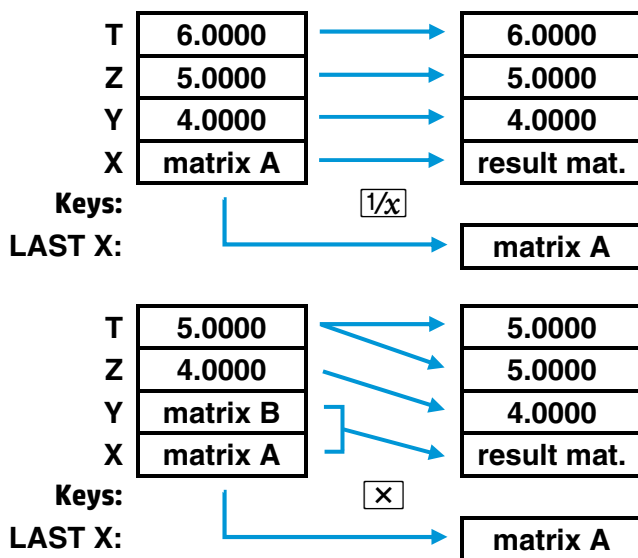

Several matrix functions operate on the matrix specified in the X-register only and store the result in the same matrix. For these operations the contents of the stack (including the LAST X register) are not moved—although the display changes to show the new dimensions if necessary.

For the **MATRIX** 7, **MATRIX** 8, and **MATRIX** 9 functions, the matrix descriptor specified in the X-register is placed in the LAST X register and the norm or (for **MATRIX** 9) the determinant is placed in the X-register. The Y-, Z-, and T-registers aren't changed.

When you recall descriptors or matrix elements into the X-register (with the stack enabled), other descriptors and numbers already in the stack move up in the stack—and the contents of the T-register are lost. (The LAST X register is not changed.) When you store descriptors or matrix elements, the stack (and the LAST X register) isn't changed.

In contrast to the operation described above, the **STO** **g** and **RCL** **g** functions do not affect the LAST X register and operate as shown on the next page.

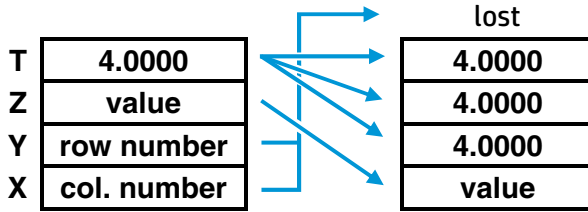

Keys: STO 9 A

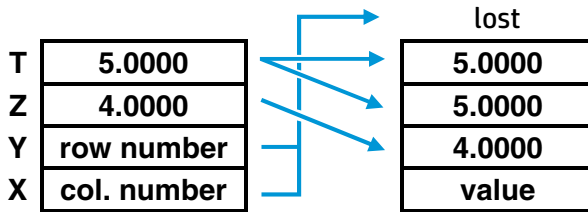

Keys: RCL 9 A

Using Matrix Operations in a Program

If the calculator is in User mode during program entry when you enter a STO or RCL {A through E, (i)} instruction to store or recall a matrix element, a **u** replaces the dash usually displayed after the line number. When this line is executed in a running program, it operates as though the calculator were in User mode. That is, the row and column numbers in R_0 and R_1 are automatically incremented according to the dimensions of the specified matrix. This allows you to access elements sequentially. (The **USER** annunciator has no effect during program execution.)

In addition, when the last element is accessed by the “User” STO or RCL instruction—when R_0 and R_1 are returned to 1—program execution skips the next line. This is useful for programming a loop that stores or recalls each matrix element, then continues executing the program. For example, the following sequence squares all elements of matrix **D**:

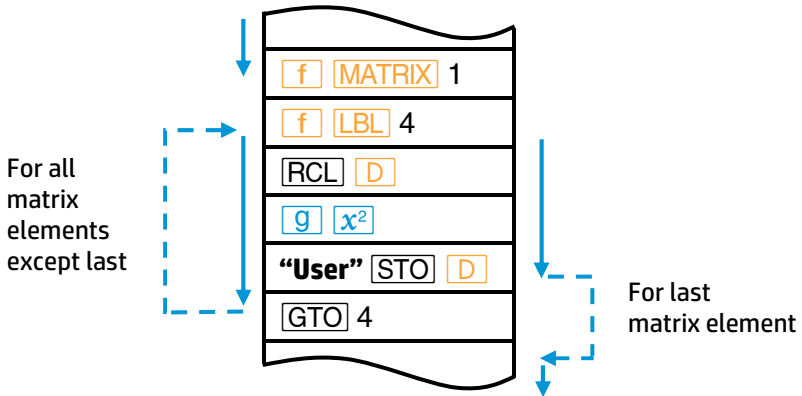

The **MATRIX** 7 (row norm) and **MATRIX** 8 (Frobenius norm) functions also operate as conditional branching instructions in a program. If the X-register contains a matrix descriptor, these functions calculate the norm in the usual manner, and program execution continues with the next program line. If the X-register contains a number, program execution skips the next line. In both cases, the original contents of the X-register are stored in the LAST X register. This is useful for testing whether a matrix descriptor is in the X-register during a program.

Summary of Matrix Functions

| Keystroke(s) | Results |
|--|---|
| g Cy,x | Transforms Z^P into Z^C . |
| CHS | Changes sign of all elements in matrix specified in X-register. |
| f DIM { A through E , I } | Dimensions specified matrix. |
| f MATRIX 0 | Dimensions all matrices to 0×0 . |
| f MATRIX 1 | Sets row and column numbers in R_0 and R_1 to 1. |
| f MATRIX 2 | Transform Z^P into \tilde{Z} . |
| f MATRIX 3 | Transforms \tilde{Z} into Z^P . |
| f MATRIX 4 | Calculates transpose of matrix specified in X-register. |

178 Section 12: Calculating with Matrices

| Keystroke(s) | Results |
|--|---|
| \boxed{f} $\boxed{\text{MATRIX}}$ 5 | Multiplies transpose of matrix specified in Y-register with matrix specified in X-register. Stores in result matrix. |
| \boxed{f} $\boxed{\text{MATRIX}}$ 6 | Calculates residual in result matrix. |
| \boxed{f} $\boxed{\text{MATRIX}}$ 7 | Calculates row norm of matrix specified in X-register. |
| \boxed{f} $\boxed{\text{MATRIX}}$ 8 | Calculates Frobenius or Euclidean norm of matrix specified in X-register. |
| \boxed{f} $\boxed{\text{MATRIX}}$ 9 | Calculates determinant of matrix specified in X-register. Place LU in result matrix. |
| \boxed{f} $\boxed{P_{y,x}}$ | Transforms \mathbf{Z}^C into \mathbf{Z}^P . |
| $\boxed{\text{RCL}}$ $\boxed{[A]}$ through $\boxed{[E]}$, $\boxed{(i)}$ | Recalls value from specified matrix, using row and column numbers in R_0 and R_1 . |
| $\boxed{\text{RCL}}$ $\boxed{9}$ $\boxed{[A]}$ through $\boxed{[E]}$, $\boxed{(i)}$ | Recalls value from specified matrix using row and column numbers in Y- and X-registers. |
| $\boxed{\text{RCL}}$ $\boxed{\text{DIM}}$ $\boxed{[A]}$ through $\boxed{[E]}$, $\boxed{(i)}$ | Recalls dimensions of specified matrix into X- and Y-registers. |
| $\boxed{\text{RCL}}$ $\boxed{\text{MATRIX}}$ $\boxed{[A]}$ through $\boxed{[E]}$ | Displays descriptor of specified matrix. |
| $\boxed{\text{RCL}}$ $\boxed{\text{RESULT}}$ | Displays descriptor of result matrix. |
| \boxed{f} $\boxed{\text{RESULT}}$ $\boxed{[A]}$ through $\boxed{[E]}$ | Designates specified matrix as result matrix. |
| $\boxed{\text{STO}}$ $\boxed{[A]}$ through $\boxed{[E]}$, $\boxed{(i)}$ | Stores value from display into element of specified matrix, using row and column numbers in R_0 and R_1 . |
| $\boxed{\text{STO}}$ $\boxed{9}$ $\boxed{[A]}$ through $\boxed{[E]}$, $\boxed{(i)}$ | Stores value from Z-register into element of specified matrix, using row and column numbers in Y- and X-registers. |
| $\boxed{\text{STO}}$ $\boxed{\text{MATRIX}}$ $\boxed{[A]}$ through $\boxed{[E]}$ | If matrix descriptor is in display, copies all elements of that matrix into corresponding elements of specified matrix. If number is in display, stores that value in all elements of specified matrix. |

| Keystroke(s) | Results |
|--|--|
| $\boxed{\text{STO}}$ $\boxed{\text{RESULT}}$ | Designates matrix specified in X-register as result matrix. |
| $\boxed{\text{f}}$ $\boxed{\text{USER}}$ | Row and column numbers in R_0 and R_1 are automatically incremented each time $\boxed{\text{STO}}$ or $\boxed{\text{RCL}}$ { $\boxed{\text{A}}$ through $\boxed{\text{E}}$, $\boxed{\text{(i)}}$ } is pressed. |
| $\boxed{1/x}$ | Inverts matrix specified in X-register. Stores in result matrix. Use $\boxed{\text{f}}$ $\boxed{1/x}$ if User mode is on. |
| $\boxed{+}$, $\boxed{-}$ | If matrix descriptors specified in both X- and Y-registers, adds or subtracts corresponding elements of matrices specified. If matrix descriptor specified in only one of these registers, performs addition or subtraction with all elements in specified matrix and scalar in other register. Stores in result matrix. |
| $\boxed{\times}$ | If matrix descriptors specified in both X- and Y-registers, calculates product of specified matrices (as \mathbf{YX}). If matrix specified in only one of these registers, multiplies all elements in specified matrix by scalar in other register. Stores in result matrix. |
| $\boxed{\div}$ | If matrix descriptors specified in both X- and Y-registers, multiplies inverse of matrix specified in X-register with matrix specified in Y-register. If matrix specified in only Y-register, divides all elements of specified matrix by scalar in other register. If matrix specified in only X-register, multiplies each element of inverse of specified matrix by scalar in other register. Stores in result matrix. |

For Further Information

The *HP 15c Advanced Functions Handbook* presents more detailed and technical aspects of the matrix functions in the HP 15c, including applications. The topics include: least-squares calculations, solving nonlinear equations, ill-conditioned and singular matrices, accuracy considerations, iterative refinement, and creating the identity matrix.

Section 13

Finding the Roots of an Equation

In many applications you need to solve equations of the form

$$f(x) = 0.*$$

This means finding the values of x that satisfy the equation. Each such value of x is called a *root* of the equation $f(x) = 0$ and a *zero* of the function $f(x)$. These roots (or zeros) that are real numbers are called *real roots* (or real zeros). For many problems the roots of an equation can be determined analytically through algebraic manipulation; in many other instances, this is not possible. Numerical techniques can be used to estimate the roots when analytical methods are not suitable. When you use the **SOLVE** key on your HP 15c, you utilize an advanced numerical technique that lets you effectively and conveniently find *real roots* for a wide range of equations.†

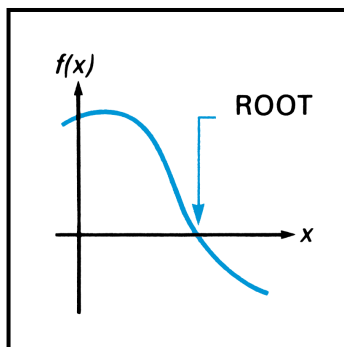

Using **SOLVE**

In calculating roots, the **SOLVE** operation repeatedly calls up and executes a subroutine *that you write* for evaluating $f(x)$.

* Actually, *any* equation with one variable can be expressed in this form. For example, $f(x) = a$ is equivalent to $f(x) - a = 0$, and $f(x) = g(x)$ is equivalent to $f(x) - g(x) = 0$.

† The **SOLVE** function does not use the imaginary stack. Refer to the *HP 15c Advanced Functions Handbook* for information about complex roots.

The basic rules for using **SOLVE** are:

1. In Program mode, key in a subroutine that evaluates the function $f(x)$ that is to be equated to zero. This subroutine must begin with a label instruction (**f** **LBL** *label*) and end up with a result for $f(x)$ in the X-register.

In Run mode:

2. Key two initial estimates of the desired root, separated by **ENTER**, into the X- and Y-registers. These estimates merely indicate to the calculator the approximate range of x in which it should initially seek a root of $f(x) = 0$.
3. Press **f** **SOLVE** followed by the label of your subroutine. The calculator then searches for the desired zero of your function and displays the result. If the function that you are analyzing equals zero at more than one value of x , the routine will stop when it finds any one of those values. To find additional values, you can key in different initial estimates and use **SOLVE** again.

Immediately before **SOLVE** addresses your subroutine it places a value of x in the X-, Y-, Z-, and T-registers. This value is then used by your subroutine to calculate $f(x)$. Because the entire stack is filled with the x -value, this number is continually available to your subroutine. (The use of this technique is described on page 41).

Example: Use **SOLVE** to find the values of x for which

$$f(x) = x^2 - 3x - 10 = 0.$$

Using Horner's method (refer to page 79), you can rewrite $f(x)$ so that it is programmed more efficiently:

$$f(x) = (x - 3)x - 10.$$

In Program mode, key in the following subroutine to evaluate $f(x)$.

Keystrokes

g **P/R**

f **CLEAR** **PRGM**

Display

000-

000-

Program mode.

Clear program memory.

182 Section 13: Finding the Roots of an Equation

Keystrokes

Display

| | | |
|-----------------------|--------------|--|
| f LBL 0 | 001-42,21, 0 | Begin with LBL instruction. Subroutine assumes stack loaded with x. |
| 3 | 002- 3 | |
| - | 003- 30 | Calculate $x - 3$. |
| × | 004- 20 | Calculate $(x - 3)x$. |
| 1 | 005- 1 | |
| 0 | 006- 0 | |
| - | 007- 30 | Calculate $(x - 3)x - 10$. |
| g RTN | 008- 43 32 | |

In Run mode, key two initial estimates into the X- and Y-registers. Try estimates of 0 and 10 to look for a positive root.

Keystrokes

Display*

| | | |
|---------------------|--------|----------------------|
| g P/R | | Run mode. |
| 0 ENTER | 0.0000 | } Initial estimates. |
| 10 | 10 | |

You can now find the desired root by pressing **f** **SOLVE** 0. When you do this, the calculator will not display the answer right away. The HP 15c uses an iterative algorithm[†] to estimate the root. The algorithm analyzes your function by sampling it many times, perhaps a dozen times or more. It does this by repeatedly executing your subroutine. Finding a root will usually require less than 5 seconds, but sometimes the process will require even more time.

Press **f** **SOLVE** 0 and sit back while your HP 15c exhibits one of its powerful capabilities. The display flashes **running** while **SOLVE** is operating.

* Press **f** **FIX** 4 to obtain the displays shown here. The display setting does not influence the operation of **SOLVE**.

[†] An *algorithm* is a step-by-step procedure for solving a mathematical problem. An *iterative* algorithm is one containing a portion that is executed a number of times in the process of solving the problem.

Keystrokes

f SOLVE 0

Display

5.0000

The desired root.

After the routine finds and displays the root, you can ensure that the displayed number is indeed a root of $f(x) = 0$ by checking the stack. You have seen that the display (X-register) contains the desired root. The Y-register contains a previous estimate of the root, which should be very close to the displayed root. The Z-register contains the value of your function evaluated at the displayed root.

Keystrokes

R↓

Display

5.0000

A previous estimate of the root.

R↓

0.0000

Value of the function at the root showing that $f(x) = 0$.

Quadratic equations, such as the one you are solving, can have two roots. If you specify two new initial estimates, you can check for a second root. Try estimates of 0 and -10 to look for a negative root.

Keystrokes

0 ENTER

10 CHS

f SOLVE 0

R↓

R↓

Display

0.0000

-10

-2.0000

-2.0000

0.0000

} Initial estimates.

The second root.

A previous estimate of the root.

Value of $f(x)$ at second root.

184 Section 13: Finding the Roots of an Equation

You have now found the two roots of $f(x) = 0$. Note that this quadratic equation *could* have been solved algebraically—and you would have obtained the same roots that you found using **SOLVE**.

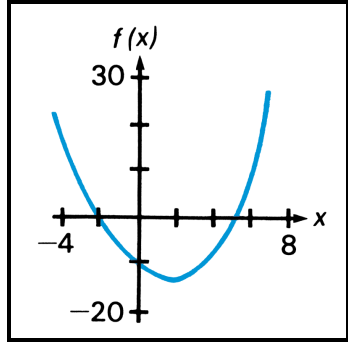

Graph of $f(x)$

The convenience and power of the **SOLVE** key become more apparent when you solve an equation for a root that cannot be determined algebraically.

Example: Champion ridget hurler Chuck Fahr throws a ridget with an upward velocity of 50 meters/second. If the height of the ridget is expressed as

$$h = 5000(1 - e^{-t/20}) - 200t,$$

how long does it take for it to reach the ground again? In this equation, h is the height in meters and t is the time in seconds.



Solution: The desired solution is the positive value of t at which $h = 0$.

Use the following subroutine to calculate the height.

Keystrokes

Display

| | | |
|------------------------------|----------------|---|
| G P/R | 000- | |
| f LBL A | 001-42, 21, 11 | Begin with label. |
| 2 | 002- | 2 Subroutine assumes t is loaded in X- and Y-registers. |
| 0 | 003- | 0 |
| ÷ | 004- | 10 |

| Keystrokes | Display | |
|---|---------|---|
| $\boxed{\text{CHS}}$ | 005- | 16 $-t/20.$ |
| $\boxed{e^x}$ | 006- | 12 |
| $\boxed{\text{CHS}}$ | 007- | 16 $-e^{-t/20}.$ |
| 1 | 008- | 1 |
| $\boxed{+}$ | 009- | 40 $1 - e^{-t/20}.$ |
| 5 | 010- | 5 |
| 0 | 011- | 0 |
| 0 | 012- | 0 |
| 0 | 013- | 0 |
| $\boxed{\times}$ | 014- | 20 $5000(1 - e^{-t/20}).$ |
| $\boxed{\text{X}\rightrightarrows\text{Y}}$ | 015- | 34 Brings another t -value into X-register. |
| 2 | 016- | 2 |
| 0 | 017- | 0 |
| 0 | 018- | 0 |
| $\boxed{\times}$ | 019- | 20 $200t.$ |
| $\boxed{-}$ | 020- | 30 $5000(1 - e^{-t/20}) - 200t.$ |
| $\boxed{\text{g}} \boxed{\text{RTN}}$ | 021- | 43 32 |

Switch to Run mode, key in two initial estimates of the time (for example, 5 and 6 seconds) and execute $\boxed{\text{SOLVE}}$.

| Keystrokes | Display | |
|--|---------|----------------------|
| $\boxed{\text{g}} \boxed{\text{P/R}}$ | | Run mode. |
| 5 $\boxed{\text{ENTER}}$ | 5.0000 | } Initial estimates. |
| 6 | 6 | |
| $\boxed{\text{f}} \boxed{\text{SOLVE}} \boxed{\text{A}}$ | 9.2843 | The desired root. |

Verify the root by reviewing the Y- and Z-registers.

| Keystrokes | Display | |
|------------------------------|---------|--|
| $\boxed{\text{R}\downarrow}$ | 9.2843 | A previous estimate of the root. |
| $\boxed{\text{R}\downarrow}$ | 0.0000 | Value of the function at the root showing that $h = 0$. |

186 Section 13: Finding the Roots of an Equation

Fahr's ridget falls to the ground 9.2843 seconds after he hurls it—a remarkable toss.

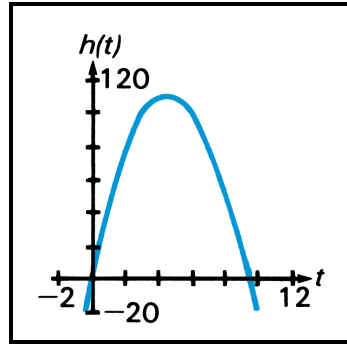

Graph of h versus t

When No Root Is Found

You have seen how the **SOLVE** key estimates and displays a root of an equation of the form $f(x) = 0$. However, it is possible that an equation has no real roots (that is, there is no real value of x for which the equality is true). Of course, you would not expect the calculator to find a root in this case. Instead, it displays **Error 8**.

Example: Consider the equation

$$|x| = -1$$

which has no solution since the absolute value function is never negative. Express this equation in the required form

$$|x| + 1 = 0$$

and attempt to use **SOLVE** to find a solution.

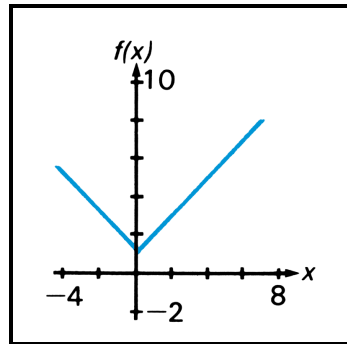

Graph of $f(x) = |x| + 1$

Keystrokes

- g** **P/R**
- f** **LBL** 1
- g** **ABS**
- 1
- +**
- g** **RTN**

Display

- 000-
- 001-42,21, 1
- 002- 43 16
- 003- 1
- 004- 40
- 005- 43 32

Program mode.

Because the absolute-value function is minimum near an argument of zero, specify the initial estimates in that region, for instance 1 and -1. Then attempt to find a root.

| Keystrokes | Display | |
|-------------------------|----------------|--|
| g P/R | | Run mode. |
| 1 ENTER | 1 . 0000 | } Initial estimates. |
| 1 CHS | -1 | |
| f SOLVE 1 | Error 8 | This display indicates that no root was found. |
| ← | 0 . 0000 | Clear error display. |

As you can see, the HP 15c stopped seeking a root of $f(x) = 0$ when it decided that none existed—at least not in the general range of x to which it was initially directed. The **Error 8** display does not indicate that an “illegal” operation has been attempted; it merely states that no root was found where **SOLVE** presumed one might exist (based on your initial estimates).

If the HP 15c stops seeking a root and displays an error message, one of these three types of conditions has occurred:

- If repeated iterations all produce a constant nonzero value for the specified function, execution stops with the display **Error 8**.
- If numerous samples indicate that the *magnitude* of the function appears to have a nonzero minimum value in the area being searched, execution stops with the display **Error 8**.
- If an improper argument is used in a mathematical operation as part of your subroutine, execution stops with the display **Error 0**.

In the case of a constant function value, the routine can see no indication of a tendency for the value to move toward zero. This can occur for a function whose first 10 significant digits are constant (such as when its graph levels off at a nonzero horizontal asymptote) or for a function with a relatively broad, local “flat” region in comparison to the range of x -values being tried.

In the case where the function’s magnitude reaches a nonzero minimum, the routine has logically pursued a sequence of samples for which the magnitude has been getting smaller. However, it has not found a value of x at which the function’s graph touches or crosses the x -axis.

The final case points out a potential deficiency in the subroutine rather than a limitation of the root-finding routine. Improper operations may sometimes be avoided by specifying initial estimates that focus the search in a region where such an outcome will not occur. However, the `SOLVE` routine is very aggressive and may sample the function over a wide range. It is a good practice to have your subroutine test or adjust potentially improper arguments prior to performing an operation (for instance, use `ABS` prior to `√x`). Rescaling variables to avoid large numbers can also be helpful.

The success of the `SOLVE` routine in locating a root depends primarily upon the nature of the function it is analyzing and the initial estimates at which it begins searching. The mere existence of a root does not ensure that the casual use of the `SOLVE` key will find it. If the function $f(x)$ has a nonzero horizontal asymptote or a local minimum of its magnitude, the routine can be expected to find a root of $f(x) = 0$ only if the initial estimates do not concentrate the search in one of these unproductive regions—and, of course, if a root actually exists.

Choosing Initial Estimates

When you use `SOLVE` to find the root of an equation, the two initial estimates that you provide determine the values of the variable x at which the routine begins its search. In general, the likelihood that you will find the particular root you are seeking increases with the level of understanding that you have about the function you are analyzing. Realistic, intelligent estimates greatly facilitate the determination of a root.

The initial estimates that you use may be chosen in a number of ways:

If the variable x has a limited range in which it is conceptually meaningful as a solution, it is reasonable to choose initial estimates within this range. Frequently an equation that is applicable to a real problem has, in addition to the desired solution, other roots that are physically meaningless. These usually occur because the equation being analyzed is appropriate only between certain limits of the variable. You should recognize this restriction and interpret the results accordingly.

If you have some knowledge of the behavior of the function $f(x)$ as it varies with different values of x , you are in a position to specify initial estimates in the general vicinity of a zero of the function. You can also avoid the more troublesome ranges of x such as those producing a relatively constant function value or a minimum of the function's magnitude.

Example: Using a rectangular piece of sheet metal 4 decimeters by 8 decimeters, an open-top box having a volume of 7.5 cubic decimeters is to be formed. How should the metal be folded? (A taller box is preferred to a shorter one.)

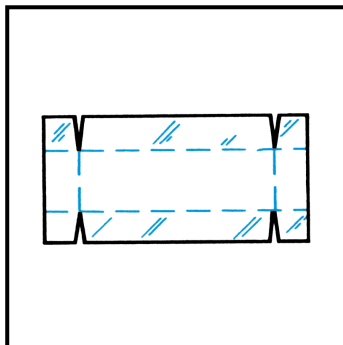

Solution: You need to find the height of the box (that is, the amount to be folded up along each of the four sides) that gives the specified volume. If x is the height (or amount folded up), the length of the box is $(8 - 2x)$ and the width is $(4 - 2x)$. The volume V is given by

$$V = (8 - 2x)(4 - 2x)x.$$

By expanding the expression and then using Horner's method (page 79), this equation can be rewritten as

$$V = 4((x - 6)x + 8)x.$$

To get $V = 7.5$, find the values of x for which

$$f(x) = 4((x - 6)x + 8)x - 7.5 = 0.$$

The following subroutine calculates $f(x)$:

| Keystrokes | Display | |
|---|--------------|--------------------------------|
| G P/R | 000- | Program mode. |
| f LBL 3 | 001-42,21, 3 | Label. |
| 6 | 002- | 6 Assumes stack loaded with x. |

190 Section 13: Finding the Roots of an Equation

| Keystrokes | Display |
|---------------------------|------------------------------|
| $\boxed{-}$ | 003- 30 |
| $\boxed{\times}$ | 004- 20 $(x - 6)x$. |
| 8 | 005- 8 |
| $\boxed{+}$ | 006- 40 |
| $\boxed{\times}$ | 007- 20 $((x - 6)x + 8)x$. |
| 4 | 008- 4 |
| $\boxed{\times}$ | 009- 20 $4((x - 6)x + 8)x$. |
| 7 | 010- 7 |
| $\boxed{\cdot}$ | 011- 48 |
| 5 | 012- 5 |
| $\boxed{-}$ | 013- 30 |
| $\boxed{9}$ \boxed{RTN} | 014- 43 32 |

It seems reasonable that either a tall, narrow box or a short, flat box could be formed having the desired volume. Because the taller box is preferred, larger initial estimates of the height are reasonable. However, heights greater than 2 decimeters are not physically possible (because the metal is only 4 decimeters wide). Initial estimates of 1 and 2 decimeters are therefore appropriate.

Find the desired height:

| Keystrokes | Display | |
|-------------------------------|---------|----------------------|
| $\boxed{9}$ $\boxed{P/R}$ | | Run mode. |
| 1 \boxed{ENTER} | 1.0000 | } Initial estimates. |
| 2 | 2 | |
| \boxed{f} \boxed{SOLVE} 3 | 1.5000 | The desired height. |
| $\boxed{R\downarrow}$ | 1.5000 | Previous estimate. |
| $\boxed{R\downarrow}$ | 0.0000 | $f(x)$ at root. |

By making the height 1.5 decimeters, a $5.0 \times 1.0 \times 1.5$ -decimeter box is specified.

If you ignore the upper limit on the height and use initial estimates of 3 and 4 decimeters (still less than the width), you will obtain a height of 4.2026 decimeters—a root that is physically meaningless. If you use small initial estimates such as 0 and 1 decimeter, you will obtain a height of 0.2974 decimeter—producing an undesirably short, flat box.

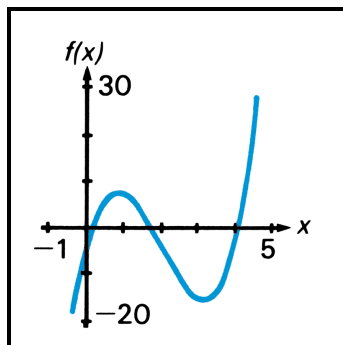

Graph of $f(x)$

As an aid for examining the behavior of a function, you can easily evaluate the function at one or more values of x using your subroutine in program memory. To do this, fill the stack with x . Execute the subroutine to calculate the value of the function (press **f** letter label or **GSB** label).

The values you calculate can be plotted to give you a graph of the function. This procedure is particularly useful for a function whose behavior you do not know. A simple-looking function may have a graph with relatively extreme variations that you might not anticipate. A root that occurs near a localized variation may be hard to find unless you specify initial estimates that are close to the root.

If you have no informed or intuitive concept of the nature of the function or the location of the zero you are seeking, you can search for a solution using trial-and-error. The success of finding a solution depends partially upon the function itself. Trial-and-error is often—but not always—successful.

- If you specify two moderately large positive or negative estimates and the function's graph does not have a horizontal asymptote, the routine will seek a zero which might be the most positive or negative (unless the function oscillates many times, as the trigonometric functions do).
- If you have already found a zero of the function, you can check for another solution by specifying estimates that are relatively distant from any known zeros.

- Many functions exhibit special behavior when their arguments approach zero. You can check your function to determine values of x for which any argument within your function becomes zero, and then specify estimates at or near those values.

Although two different initial estimates are usually supplied when using **SOLVE**, you can also use **SOLVE** with the same estimate in both the X- and Y-registers. If the two estimates are identical, a second estimate is generated internally. If your single estimate is nonzero, the second estimate differs from your estimate by one count in the seventh significant digit. If your estimate is zero, 1×10^{-7} is used as the second estimate. Then the root-finding procedure continues as it normally would with two estimates.

Using **SOLVE** in a Program

You can use the **SOLVE** operation as part of a program. Be sure that the program provides initial estimates in the X- and Y-registers just prior to the **SOLVE** operation. The **SOLVE** routine stops with a value of x in the X-register and the corresponding function value in the Z-register. If the x -value is a root, the program proceeds to the next line. If the x -value is not a root, the next line is skipped. (Refer also to Interpreting Results on page 226 for a further explanation of roots.) Essentially, the **SOLVE** instruction tests whether the x -value is a root and then proceeds according to the “Do if True” rule. The program can then handle the case of not finding a root, such as by choosing new initial estimates or changing a function parameter.

The use of **SOLVE** as an instruction in a program utilizes one of the seven pending returns in the calculator. Since the subroutine called by **SOLVE** utilizes another return, there can be only five other pending returns. Executed from the keyboard, on the other hand, **SOLVE** itself does not utilize one of the pending returns, so that six pending returns are available for subroutines within the subroutine called by **SOLVE**. Remember that if all seven pending returns have been utilized, a call to another subroutine will result in a display of **Error 5**. (Refer to page 105.)

Restriction on the Use of **SOLVE**

The one restriction regarding the use of **SOLVE** is that **SOLVE** cannot be used recursively. That is, you cannot use **SOLVE** in a subroutine that is called during the execution of **SOLVE**. If this situation occurs, execution stops and **Error 7** is displayed. It is possible, however, to use **SOLVE** with **↵** thereby using the advanced capabilities of both of these keys.

Memory Requirements

SOLVE requires five registers to operate. (Appendix C explains how they are automatically allocated from memory.) If five unoccupied registers are not available, **SOLVE** will not run and **Error 10** will be displayed.

A routine that combines **SOLVE** and **↵** requires 23 registers of space.

For Further Information

In Appendix D, Advanced Use of **SOLVE**, additional techniques and explanations for using **SOLVE** are presented. These include:

- How **SOLVE** works.
- Accuracy of the root.
- Interpreting results.
- Finding several roots.
- Limiting estimation time.

Section 14

Numerical Integration

Many problems in mathematics, science, and engineering require calculating the definite integral of a function. If the function is denoted by $f(x)$ and the interval of integration is a to b , the integral can be expressed mathematically as

$$I = \int_a^b f(x) dx.$$

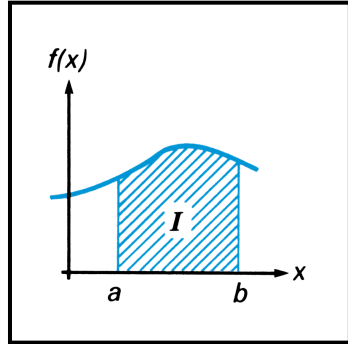

The quantity I can be interpreted geometrically as the area of a region bounded by the graph of $f(x)$, the x -axis, and the limits $x = a$ and $x = b$.*

When an integral is difficult or impossible to evaluate by analytical methods, it can be calculated using numerical techniques. Usually, this can be done only with a fairly complicated computer program. With your HP 15c, however, you can easily do numerical integration using the \int_y^x (*integrate*) key.†

Using \int_y^x

The basic rules for using \int_y^x are:

1. In Program mode, key in a subroutine that evaluates the function $f(x)$ that you want to integrate. This subroutine must begin with a label instruction (f LBL *label*) and end up with a value for $f(x)$ in the X-register.

* Provided that $f(x)$ is nonnegative throughout the interval of integration.

† The \int_y^x function does not use the imaginary stack. Refer to the *HP 15c Advanced Functions Handbook* for information about using \int_y^x in Complex mode.

In Run Mode:

2. Key the lower limit of integration (a) into the X-register, then press **ENTER** to lift it into the Y-register.
3. Key the upper limit of integration (b) into the X-register.
4. Press **f** **\int_y^x** followed by the label of your subroutine.

Example: Certain problems in physics and engineering require calculating *Bessel functions*. The Bessel function of the first kind of order 0 can be expressed as

$$J_0(x) = \frac{1}{\pi} \int_0^{\pi} \cos(x \sin \theta) d\theta.$$

Find

$$J_0(1) = \frac{1}{\pi} \int_0^{\pi} \cos(\sin \theta) d\theta.$$

In Program mode, key in the following subroutine to evaluate the function $f(\theta) = \cos(\sin \theta)$.

| Keystrokes | Display | |
|-----------------------------------|-----------------|--|
| g P/R | 000- | Program mode. |
| f CLEAR PRGM | 000- | Clear program memory. |
| f LBL 0 | 001-42 , 21 , 0 | Begin subroutine with a LBL instruction. Subroutine assumes a value of θ is in X-register. |
| SIN | 002- 23 | Calculate $\sin \theta$. |
| COS | 003- 24 | Calculate $\cos(\sin \theta)$. |
| g RTN | 004- 43 32 | |

Now, in Run mode key the lower limit of integration into the Y-register and the upper limit into the X-register. For this particular problem, you also need to specify Radians mode for the trigonometric functions.



| Keystrokes | Display | |
|---------------------------|----------|---|
| \boxed{g} $\boxed{P/R}$ | | Run mode. |
| 0 \boxed{ENTER} | 0 . 0000 | Key lower limit, 0, into Y-register. |
| \boxed{g} $\boxed{\pi}$ | 3 . 1416 | Key upper limit, π , into X-register. |
| \boxed{g} \boxed{RAD} | 3 . 1416 | Specify Radians mode for trigonometric functions. |

Now you are ready to press \boxed{f} $\boxed{\int_0^x}$ 0 to calculate the integral. When you do so, you'll find that—just as with \boxed{SOLVE} —the calculator will not display the result right away, as it does with other operations. The HP 15c calculates integrals using a sophisticated iterative algorithm. Briefly, this algorithm evaluates $f(x)$, the function to be integrated, at many values of x between the limits of integration. At each of these values, the calculator evaluates the function by executing the subroutine you write for that purpose. When the calculator must execute the subroutine many times—as it does when you press $\boxed{\int_0^x}$ —you can't expect any answer right away. Most integrals will require less than 5 seconds, but some integrals will require more time. Later on we'll discuss how you can decrease the time somewhat; but for now press \boxed{f} $\boxed{\int_0^x}$ 0 and take a break (or read ahead) while the HP 15c takes care of the drudgery for you.





| Keystrokes | Display | |
|----------------------------------|----------|---|
| \boxed{f} $\boxed{\int_0^x}$ 0 | 2 . 4040 | $= \int_0^{\pi} \cos(\sin \theta) d\theta.$ |

In general, don't forget to multiply the value of the integral by whatever constants, if any, are outside the integral. In this particular problem, we need to multiply the integral by $1/\pi$ to get $J_0(1)$:

| Keystrokes | Display | |
|---------------------------|----------|-----------|
| \boxed{g} $\boxed{\pi}$ | 3 . 1416 | |
| $\boxed{\div}$ | 0 . 7652 | $J_0(1).$ |

Before calling the subroutine you provide to evaluate $f(x)$, the  algorithm—just like the  algorithm—places the value of x in the X-, Y-, Z-, and T-registers. Because every stack register contains the x -value, your subroutine can calculate with this number without having to recall it from a storage register. The subroutines in the next two examples take advantage of this feature. (A polynomial evaluation technique that assumes the stack is filled with the value of x is discussed on page 79.)

Note: Since the calculator puts the value of x into all stack registers, any numbers previously there will be replaced by x . Therefore, if the stack contains intermediate results that you'll need after you calculate an integral, store those numbers in storage registers and recall them later.

Occasionally you may want to use the subroutine that you wrote for the  operation to merely evaluate the function at some value of x . If you do so with a function that gets x from the stack more than once, be sure to fill the stack manually with the value of x , by pressing   , before you execute the subroutine.

Example: The Bessel function of the first kind of order 1 can be expressed as

$$J_1(x) = \frac{1}{\pi} \int_0^\pi \cos(\theta - x \sin \theta) d\theta.$$

Find $J_1(1) = \frac{1}{\pi} \int_0^\pi \cos(\theta - \sin \theta) d\theta.$

Key in the following subroutine that evaluates the function $f(\theta) = \cos(\theta - \sin \theta)$.

Keystrokes

 
  1

Display

000- Program mode.
 001-42,21, 1 Begin subroutine with a label.

198 Section 14: Numerical Integration

| Keystrokes | Display | | |
|---------------------------------------|---------|-------|--|
| $\boxed{\text{SIN}}$ | 002- | 23 | Calculate $\sin \theta$. |
| $\boxed{-}$ | 003- | 30 | Since a value of θ will be placed into the Y-register by the $\boxed{\int_y^x}$ algorithm before it executes this subroutine, the $\boxed{-}$ operation at this point will calculate $(\theta - \sin \theta)$. |
| $\boxed{\text{COS}}$ | 004- | 24 | Calculate $\cos(\theta - \sin \theta)$. |
| $\boxed{\text{g}} \boxed{\text{RTN}}$ | 005- | 43 32 | |

In Run mode, key the limits of integration into the X- and Y-registers. Be sure that the trigonometric mode is set to Radians, then press $\boxed{\text{f}} \boxed{\int_y^x} 1$ to calculate the integral. Finally, multiply the integral by $1/\pi$ to calculate $J_1(1)$.

| Keystrokes | Display | |
|---|---------|---|
| $\boxed{\text{g}} \boxed{\text{P/R}}$ | | Run mode. |
| 0 $\boxed{\text{ENTER}}$ | 0.0000 | Key lower limit into Y-register. |
| $\boxed{\text{g}} \boxed{\pi}$ | 3.1416 | Key upper limit into X-register. |
| $\boxed{\text{g}} \boxed{\text{RAD}}$ | 3.1416 | (If not already in Radians mode.) |
| $\boxed{\text{f}} \boxed{\int_y^x} 1$ | 1.3825 | $= \int_0^\pi \cos(\theta - \sin \theta) d\theta$. |
| $\boxed{\text{g}} \boxed{\pi} \boxed{\div}$ | 0.4401 | $J_1(1)$. |

Example: Certain problems in communications theory (for example, pulse transmission through idealized networks) require calculating an integral (sometimes called the *sine integral*) of the form

$$Si(t) = \int_0^t \frac{\sin x}{x} dx.$$

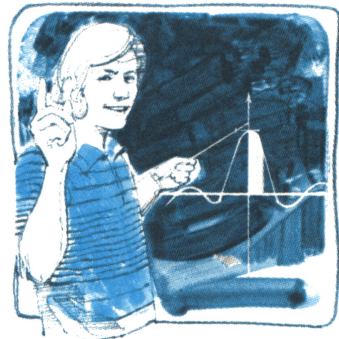

Find $S(2)$.

Key in the following subroutine to evaluate the function $f(x) = (\sin x) / x$ *

| Keystrokes | Display | |
|------------------------|-------------------|--|
| g P/R | 000- | Program mode. |
| f LBL .2 | 001-42 , 21 , . 2 | Begin subroutine with a LBL instruction. |
| SIN | 002- 23 | Calculate sin x. |
| x↔y | 003- 34 | Since a value of x will be placed in the Y-register by the ↔ algorithm before it executes this subroutine, the x↔y operation at this point will return x to the X-register and move sin x to the Y-register. |
| ÷ | 004- 10 | Divide sin x by x. |
| g RTN | 005- 43 32 | |

Now key the limits of integration into the X- and Y-registers. In Radians mode, press **f** **↔** .2 to calculate the integral.

| Keystrokes | Display | |
|----------------------|----------|-----------------------------------|
| g P/R | 0 . 4401 | Run mode. |
| 0 ENTER | 0 . 0000 | Key lower limit into Y-register. |
| 2 | 2 | Key upper limit into X-register. |
| g RAD | 2 . 0000 | (If not already in Radians mode.) |
| f ↔ .2 | 1 . 6054 | $S(2)$. |

* If the calculator attempted to evaluate $f(x) = (\sin x)/x$ at $x = 0$, the lower limit of integration, it would terminate with **Error 0** in the display (signifying an attempt to divide by zero), and the integral could not be calculated. However, the **↔** algorithm normally does *not* evaluate functions at either limit of integration, so the calculator *can* calculate the integral of a function that is undefined there. Only when the endpoints of the interval of integration are extremely close together, or the number of sample points is extremely large, does the algorithm evaluate the function at the limits of integration.

Accuracy of \int_y^x

The accuracy of the integral of any function depends on the accuracy of the function itself. Therefore, the accuracy of an integral calculated using \int_y^x is limited by the accuracy of the function calculated by your subroutine.* To specify the accuracy of the function, set the display format so that the display shows *no more* than the number of digits that you consider accurate in the function's values.† If you specify fewer digits, the calculator will compute the integral more quickly;‡ but it will presume that the function is accurate to only the number of digits specified in the display format. We'll show you how you can determine the accuracy of the calculated integral after we say another word about the display format.

You'll recall that the HP 15c provides three types of display formatting: **FIX**, **SCI**, and **ENG**. Which display format should be used is largely a matter of convenience, since for many integrals you'll get about the same results using any of them (provided that the number of digits is specified correctly, considering the magnitude of the function). Because it's more convenient to use **SCI** display format when calculating most integrals, we'll use **SCI** when calculating integrals in subsequent examples.

Note: Remember that once you have set the display format, you can change the number of digits appearing in the display by storing a number in the Index register and then pressing **f** **FIX** **I**, **f** **SCI** **I**, or **f** **ENG** **I**, as described in Section 10. This capability is especially useful when \int_y^x is executed as part of a program.

* It is possible that integrals of functions with certain characteristics (such as spikes or very rapid oscillations) *might* be calculated inaccurately. However, *this possibility is very small*. The general characteristics of functions that could cause problems, as well as techniques for dealing with them, are discussed in Appendix E.

† The accuracy of a calculated function depends on such considerations as the accuracy of empirical constants in the function as well as round-off error in the calculations. These considerations are discussed in more detail in the *HP 15c Advanced Functions Handbook*.

‡ The reason for this is discussed in Appendix E.

Because the accuracy of any integral is limited by the accuracy of the function (as indicated in the display format), the calculator cannot compute the value of an integral exactly, but rather only *approximates* it. The HP 15c places the uncertainty* of an integral's approximation in the Y-register at the same time it places the approximation in the X-register. To determine the accuracy of an approximation, check its uncertainty by pressing $\boxed{X\leftrightarrow Y}$.

Example: With the display format set to $\boxed{\text{SCI}} 2$, calculate the integral in the expression for $J_1(1)$ (from the example on page 197).

| Keystrokes | Display | |
|----------------------------------|---------|--|
| $0 \boxed{\text{ENTER}}$ | 0.0000 | Key lower limit into Y-register. |
| $\boxed{g} \boxed{\pi}$ | 3.1416 | Key upper limit into X-register. |
| $\boxed{g} \boxed{\text{RAD}}$ | 3.1416 | (If not already in Radians mode.) |
| $\boxed{f} \boxed{\text{SCI}} 2$ | 3.14 | 00 Set display format to $\boxed{\text{SCI}} 2$. |
| $\boxed{f} \boxed{\int_0^x} 1$ | 1.38 | 00 Integral approximated in $\boxed{\text{SCI}} 2$. |
| $\boxed{X\leftrightarrow Y}$ | 1.88 | -03 Uncertainty of $\boxed{\text{SCI}} 2$ approximation. |

The integral is 1.38 ± 0.00188 . Since the uncertainty would not affect the approximation until its third decimal place, you can consider all the displayed digits in this approximation to be accurate. In general, though, it is difficult to anticipate how many digits in an approximation will be unaffected by its uncertainty. This depends on the particular function being integrated, the limits of integration, and the display format.

* No algorithm for numerical integration can compute the exact difference between its approximation and the actual integral. But the algorithm in the HP 15c estimates an "upper bound" on this difference, which is the *uncertainty* of the approximation. For example, if the integral $\text{Si}(2)$ is 1.6054 ± 0.0001 , the approximation to the integral is 1.6054 and its uncertainty is 0.0001. This means that while we don't know the exact difference between the actual integral and its approximation, we *do* know that it is highly unlikely that the difference is bigger than 0.0001. (Note the first footnote on page 200.)

202 Section 14: Numerical Integration

If the uncertainty of an approximation is larger than what you choose to tolerate, you can decrease it by specifying a greater number of digits in the display format and repeating the approximation.*

Whenever you want to repeat an approximation, you don't need to key the limits of integration back into the X- and Y-registers. After an integral is calculated, not only are the approximation and its uncertainty placed in the X- and Y-registers, but in addition the upper limit of integration is placed in the Z-register, and the lower limit is placed in the T-register. To return the limits to the X- and Y-registers for calculating an integral again, simply press $\boxed{R\downarrow}$ $\boxed{R\downarrow}$.

Example: For the integral in the expression for $J_1(1)$, you want an answer accurate to four decimal places instead of only two.

| Keystrokes | Display | | |
|---|---------|-----|--|
| \boxed{f} \boxed{SCI} 4 | 1.8826 | -03 | Set display format to \boxed{SCI} 4. |
| $\boxed{R\downarrow}$ $\boxed{R\downarrow}$ | 3.1416 | 00 | Roll down stack until upper limit appears in X-register. |
| \boxed{f} $\boxed{\int \frac{x}{x^2}}$ 1 | 1.3825 | 00 | Integral approximated in \boxed{SCI} 4. |
| $\boxed{x\approx y}$ | 1.7091 | -05 | Uncertainty of \boxed{SCI} 4 approximation. |

The uncertainty indicates that this approximation is accurate to at least four decimal places. Note that the uncertainty of the \boxed{SCI} 4 approximation is about one-hundredth as large as the uncertainty of the \boxed{SCI} 2 approximation. In general, the uncertainty of any $\boxed{\int \frac{x}{x^2}}$ approximation decreases by about a factor of 10 for each additional digit specified in the display format.

* Provided that $f(x)$ is still calculated accurately to the number of digits shown in the display.

In the preceding example, the uncertainty indicated that the approximation *might* be correct to only four decimal places. If we temporarily display all 10 digits of the approximation, however, and compare it to the actual value of the integral (actually, an approximation known to be accurate to a sufficient number of decimal places), we find that the approximation is actually more accurate than its uncertainty indicates.

| Keystrokes | Display | |
|---|------------|-------------------------------------|
| $\boxed{x \approx y}$ | 1.3825 | 00 Return approximation to display. |
| \boxed{f} CLEAR $\boxed{\text{PREFIX}}$ | 1382459676 | All 10 digits of approximation. |

The value of this integral, correct to eight decimal places, is 1.38245969. The calculator's approximation is accurate to *seven* decimal places rather than only four. In fact, since the uncertainty of an approximation is calculated very conservatively, *the calculator's approximation, in most cases will be more accurate than its uncertainty indicates*. However, normally there is no way to determine *just how accurate* an approximation is.



For a more detailed look at the accuracy and uncertainty of $\boxed{\int_x^y}$ approximations, refer to Appendix E.

Using $\boxed{\int_x^y}$ in a Program

$\boxed{\int_x^y}$ can appear as an instruction in a program provided that the program is not called (as a subroutine) by $\boxed{\int_x^y}$ itself. In other words, $\boxed{\int_x^y}$ cannot be used recursively. Consequently, you cannot use $\boxed{\int_x^y}$ to calculate multiple integrals; if you attempt to do so, the calculator will halt with **Error 7** in the display. However, $\boxed{\int_x^y}$ can appear as an instruction in a subroutine called by $\boxed{\text{SOLVE}}$.



The use of $\boxed{\int_x^y}$ as an instruction in a program utilizes one of the seven pending returns in the calculator. Since the subroutine called by $\boxed{\int_x^y}$ utilizes another return, there can be only five other pending returns. Executed from the keyboard, on the other hand, $\boxed{\int_x^y}$ itself does not utilize one of the pending returns, so that six pending returns are available for subroutines within the subroutine called by $\boxed{\int_x^y}$. Remember that if all seven pending returns have been utilized, a call to another subroutine will result in a display of **Error 5**. (Refer to page 105.)

Memory Requirements

 requires 23 registers to operate. (Appendix C explains how they are automatically allocated from memory.) If 23 unoccupied registers are not available,  will not run and **Error 10** will be displayed.

A routine that combines  and  also requires 23 registers of space.

For Further Information

This section has given you the information you need to use  with confidence over a wide range of applications. In Appendix E, more esoteric aspects of  are discussed. These include:

- How  works.
- Accuracy, uncertainty, and calculation time.
- Uncertainty and the display format.
- Conditions that could cause incorrect results.
- Conditions that prolong calculation time.
- Obtaining the current approximation to an integral.

Appendix A

Error Conditions

If you attempt a calculation containing an improper operation—say division by zero—the display will show **Error** and a number. To clear an error message, press any one key. This also restores the display prior to the **Error** display.

The HP 15c has the following error messages. (The description of **Error 2** includes a list of statistical formulas used.)

Error 0: Improper Mathematics Operation

Illegal argument to math routine:

$\boxed{\div}$, where $x = 0$.

$\boxed{y^x}$, where:

- out of Complex mode, $y < 0$ and x is noninteger;
- out of Complex mode, $y = 0$ and $x \leq 0$; or
- in Complex mode, $y = 0$ and $\text{Re}(x) \leq 0$.

$\boxed{\sqrt{x}}$, where, out of Complex mode, $x < 0$.

$\boxed{1/x}$, where $x = 0$.

$\boxed{\text{LOG}}$, where:

- out of Complex mode, $x \leq 0$; or
- in Complex mode, $x = 0$.

$\boxed{\text{LN}}$, where:

- out of Complex mode, $x \leq 0$; or
- in Complex mode, $x = 0$.

$\boxed{\text{SIN}^{-1}}$, where, out of Complex mode, $|x| > 1$.

$\boxed{\text{COS}^{-1}}$, where, out of Complex mode, $|x| > 1$.

$\boxed{\text{STO}}$ $\boxed{\div}$, where $x = 0$.

$\boxed{\text{RCL}}$ $\boxed{\div}$, where the contents of the addressed register = 0.

$\boxed{\Delta\%}$, where the value in the Y-register is 0.

$\boxed{\text{HYP}^{-1}}$ $\boxed{\text{COS}}$, where, out of Complex mode, $x < 1$.

$\boxed{\text{HYP}^{-1}}$ $\boxed{\text{TAN}}$, where, out of Complex mode, $|x| > 1$.

206 Appendix A: Error Conditions

$C_{y,x}$ or $P_{y,x}$, where:

- x or y is noninteger;
- $x < 0$ or $y < 0$;
- $x > y$; or
- x or $y \geq 10^{10}$.

Error 1: Improper Matrix Operation

Applying an operation other than a matrix operation to a matrix, that is, attempting a nonmatrix operation while a matrix is in the relevant register (whether the X- or Y-register or a storage register).

Error 2: Improper Statistics Operation

\bar{x} $n = 0$

s $n \leq 1$

\hat{y}, r $n \leq 1$

$L.R.$ $n \leq 1$

Error 2 is also displayed if division by zero or the square root of a negative number would be required during computation with any of the following formulas:

$$\bar{x} = \frac{\sum x}{n} \qquad \bar{y} = \frac{\sum y}{n}$$

$$s_x = \sqrt{\frac{M}{n(n-1)}} \qquad s_y = \sqrt{\frac{N}{n(n-1)}} \qquad r = \frac{P}{\sqrt{M \cdot N}}$$

$$A = \frac{P}{M} \qquad B = \frac{M\sum y - P\sum x}{n \cdot M}$$

$$\hat{y} = \frac{M\sum y + P(n \cdot \bar{x} - \sum x)}{n \cdot M}$$

where:

$$M = n\sum x^2 - (\sum x)^2$$

$$N = n\sum y^2 - (\sum y)^2$$

$$P = n\sum xy - \sum x \sum y$$

(A and B are the values returned by the operation $L.R.$, where $y = Ax + B$.)

Error 3: Improper Register Number or Matrix Element

Storage register named is nonexistent or matrix element indicated is nonexistent.

Error 4: Improper Line Number or Label Call

Line number called for is currently unoccupied or nonexistent (>672); or you have attempted to load a program line without available space; or the label called does not exist; or User mode is on and you did not press \boxed{f} before $\boxed{\sqrt{x}}$, $\boxed{e^x}$, $\boxed{10^x}$, $\boxed{y^x}$ or $\boxed{1/x}$.

Error 5: Subroutine Level Too Deep

Subroutine nested more than seven deep.

Error 6: Improper Flag Number

Attempted a flag number >9.

Error 7: Recursive $\boxed{\text{SOLVE}}$ or $\boxed{\int y^x}$

A subroutine which is called by $\boxed{\text{SOLVE}}$ also contains a $\boxed{\text{SOLVE}}$ instruction; a subroutine which is called by $\boxed{\int y^x}$ also contains an $\boxed{\int y^x}$ instruction.

Error 8: No Root

$\boxed{\text{SOLVE}}$ unable to find a root using given estimates.

Error 9: Service

An incompatible self-test from the original HP-15C was attempted. This error can be ignored. See Appendix F for the correct HP 15c CE self-tests.

Error 10: Insufficient Memory

There is not enough memory available to perform a given operation.

Error 11: Improper Matrix Argument

Inconsistent or improper matrix arguments for a given matrix operation:

$\boxed{+}$ or $\boxed{-}$, where the dimensions are incompatible.

$\boxed{\times}$, where:

- the dimensions are incompatible; or
- the result is one of the arguments.

208 Appendix A: Error Conditions

$1/x$, where the matrix is not square.

scalar/matrix \div , where the matrix is not square.

\div , where:

- the matrix in the X-register is not square;
- the dimensions are incompatible; or
- the result is the matrix in the X-register.

MATRIX 2, where the input is a scalar; or the number of rows is odd.

MATRIX 3, where the input is a scalar; or the number of columns is odd.

MATRIX 4, where the input is scalar.

MATRIX 5, where:

- the input is a scalar;
- the dimensions are incompatible; or
- the result is one of the arguments.

MATRIX 6, where:

- the input is scalar;
- the dimensions are incompatible (including the result); or
- the result is one of the arguments.

MATRIX 9, where the matrix is not square.

RCL **DIM** **I**, where contents of R_i are scalar.

DIM **I**, where contents of R_i are scalar.

STO **RESULT**, where the input is scalar.

P_{y,x}, where the number of columns is odd.

C_{y,x}, where the number of rows is odd.

Pr Error: Power Error

Continuous Memory interrupted and reset because of power failure.

Appendix B

Stack Lift and the LAST X Register

The HP 15c calculator has been designed to operate in a natural manner. As you have seen working through this handbook, most calculations do not require you to think about the operation of the automatic memory stack.

There are occasions, however—especially as you delve into programming—when you need to know the effect of a particular operation upon the stack. The following explanation should help you.

Digit Entry Termination

Most operations on the calculator, whether executed as instructions in a program or pressed from the keyboard, terminate digit entry. This means that the calculator knows that any digits you key in after any of these operations are part of a new number.

The only operations that do *not* terminate digit entry are the digit entry keys themselves:

through

Stack Lift

There are three types of operations on the calculator based on how they affect stack lift. These are stack-disabling operations, stack-enabling operations, and neutral operations.

When the calculator is in Complex mode, each operation affects both the real and imaginary stacks. The stack lift effects are the same. In addition, the number keyed into the display (real X-register) *after any operation except* or is accompanied by the placement of a zero in the imaginary X-register.

Disabling Operations

Stack Lift. There are four stack-disabling operations on the calculator.* These operations disable the stack lift, so that a number keyed in after one of these disabling operations writes over the current number in the displayed X-register and the stack does not lift. These special disabling operations are:



Imaginary X-Register. A zero is placed in the imaginary X-register when the next number following **ENTER**, **Σ+**, or **Σ-** is keyed or recalled into the display (real X-register). However, the next number keyed in or recalled after **←** or **CLX** does not change the contents of the imaginary X-register.

Enabling Operations

Stack Lift. Most of the operations on the keyboard, including one- and two-number mathematical functions like **x²** and **×**, are stack-enabling operations. This means that a number keyed in after one of these operations will lift the stack (because the stack has been “enabled” to lift). Both the real and imaginary stacks are affected. (Recall that a shaded X-register means that its contents will be written over when the next number is keyed in or recalled.)

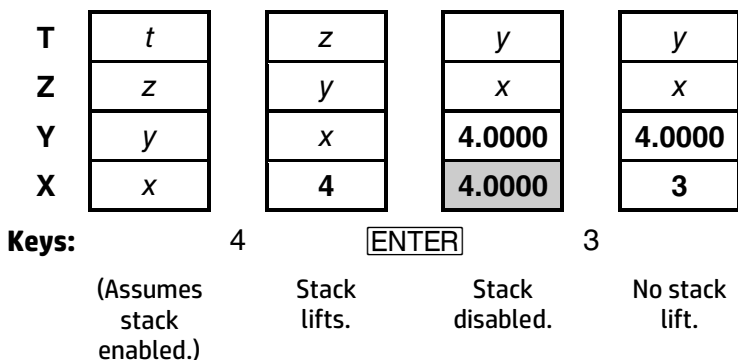

* Refer to footnote, page 36.

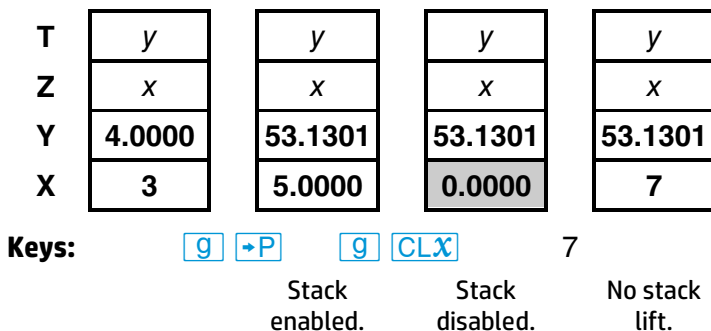

Imaginary X-Register. All enabling functions provide for a zero to be placed in the imaginary X-register *when the next number is keyed or recalled into the display.*

Neutral Operations

Stack Lift. Some operations, like FIX, are neutral; that is, they do not alter the previous status of the stack lift. Thus, if you disable the stack lift by pressing ENTER, then press f FIX *n* and key in a new number, that number will write over the number in the X-register and the stack will not lift. Similarly, if you have previously enabled the stack lift by executing, say √x, then execute a FIX instruction followed by a digit entry sequence, the stack will lift.*

The following operations are neutral on the HP 15c:

- | | | | |
|-----|-----|-------|------------------|
| FIX | GRD | USER | R/S |
| SCI | GTO | CHS | <i>nnn</i> |
| ENG | BST | CLEAR | PREFIX |
| DEG | SST | CLEAR | REG |
| RAD | MEM | CLEAR | Σ |
| | | PSE | (i) [†] |

Imaginary X-Register. The above operations are also neutral with respect to clearing the imaginary X-register.

* All digit entry functions are also neutral *during* digit entry. After digit entry termination, CHS and EEX are lift enabling; ◀ is disabling.

† That is, the f (i) sequence used to view the imaginary X-register.

LAST X Register

The following operations save x in the LAST X register:

| | | | |
|------------|-----------------------|-----------------------|----------------------|
| $-$ | x^2 | HYP^{-1} COS | % |
| $+$ | SIN | HYP^{-1} TAN | $\Delta\%$ |
| \times | COS | \rightarrow H.MS | \rightarrow P |
| \div | TAN | \rightarrow H | \rightarrow R |
| ABS | SIN^{-1} | \rightarrow DEG | $P_{y,x}$ * |
| FRAC | COS^{-1} | \rightarrow RAD | $C_{y,x}$ * |
| INT | TAN^{-1} | LN | $\Sigma+$ |
| RND | HYP SIN | e^x | $\Sigma-$ |
| $1/x$ | HYP COS | LOG | \hat{y},r |
| $x!$ | HYP TAN | 10^x | MATRIX 5 through 9 |
| \sqrt{x} | HYP^{-1} SIN | y^x | $\int \frac{x}{y}$ † |

* Except when used as a matrix function.

† $\int \frac{x}{y}$ uses the LAST X register in a special way, as described in Appendix E.

Appendix C

Memory Allocation

The Memory Space

Storage registers, program lines, and advanced function execution* all draw on a common memory space in the HP 15c. The *availability* of memory for a specific purpose depends on the current *allocation* of memory, as well as on the total memory capacity of the calculator.

Registers

Memory space in the HP 15c is allocated on the basis of *registers*. This space is partitioned into two pools, which strictly define how a register may be used. There is always a combined total of 99 registers in these two pools.

- The *data storage pool* contains registers which may be used *only* for data storage. At power-up (Continuous Memory reset) this equals 21 registers. This pool contains at least three registers at all times: R_1 , R_0 , and R_{-1} .
- The *common pool* contains uncommitted registers available for allocation to programming, matrices, the imaginary stack, and **SOLVE** and  operation. At power-up there are 78 uncommitted registers in the common pool.

* The use of **SOLVE**, , Complex mode, or matrices temporarily requires extra memory space, as explained later in this appendix.

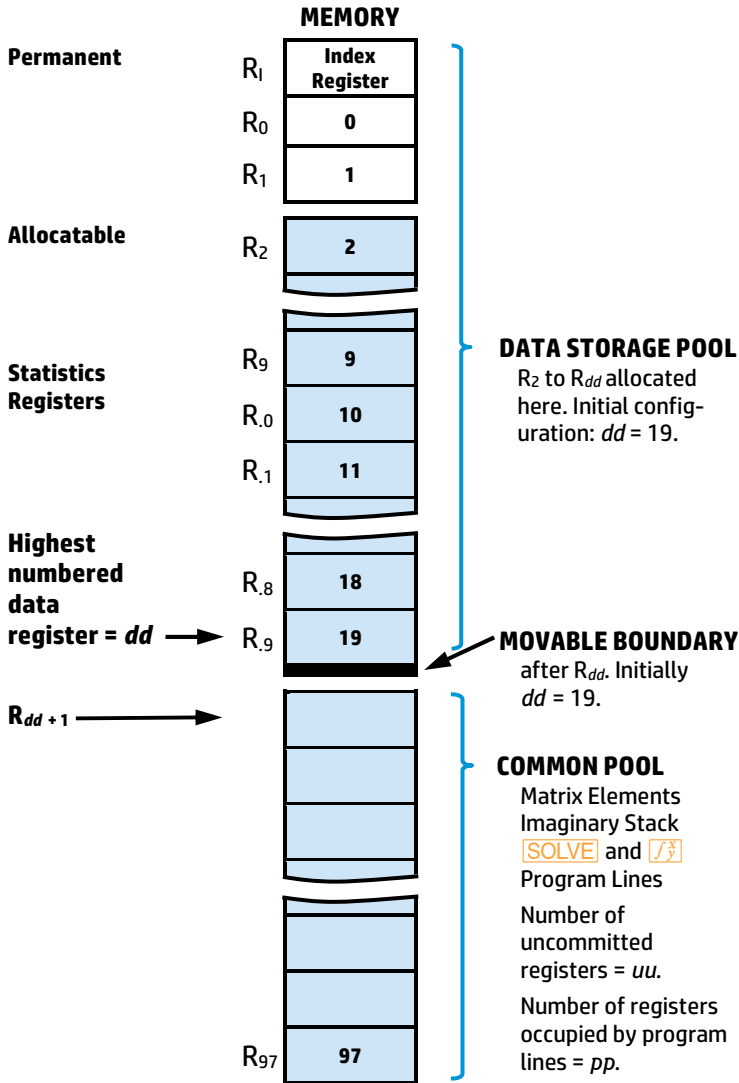

Total allocatable memory: 96 registers, numbered R₂ through R₉₇.
 $[(dd - 1) + uu + pp + (\text{matrix elements}) + (\text{imaginary stack}) + ([\text{SOLVE}] \text{ and } [])] = 96$. For memory allocation and indirect addressing, data registers R₀ through R₉ are referred to as R₁₀ through R₁₉.

Memory Status (MEM)

To view the current memory configuration of the calculator, press $\boxed{9}$ $\boxed{\text{MEM}}$ (*memory*), holding $\boxed{\text{MEM}}$ to retain the display.* The display will be four numbers,

$$dd \quad uu \quad pp-b$$

where:

dd = the number of the *highest-numbered* register in the data storage pool (making the *total number* of data registers $dd + 2$ because of R_0 and R_1);

uu = the number of *uncommitted* registers in the common pool;

pp = the number of registers containing *program* instructions; and

b = the number of *bytes* left before uu is decremented (to supply seven more bytes of program memory) and pp is incremented.

The initial status of the HP 15c at power-up is:

$$19 \quad 78 \quad 00-0$$

The movable boundary between the data storage and common pools is always between R_{dd} and R_{dd+1} .

Memory Reallocation

There are 99 registers in memory, worth seven bytes each. Ninety-six of these registers (R_2 to R_{97}) are interconvertible between the data storage and common pools.

The $\boxed{\text{DIM}}$ $\boxed{(i)}$ Function

If you should require more common space (as for programming) or more data storage space (but not both simultaneously!), you can make the necessary register reallocation using $\boxed{\text{DIM}}$ $\boxed{(i)}$.† The procedure is:

* $\boxed{\text{MEM}}$ is nonprogrammable.

† $\boxed{\text{DIM}}$ (*dimension*) is so called because it is also used (with $\boxed{\text{A}}$ through $\boxed{\text{E}}$ or $\boxed{\text{I}}$) to dimension matrices. Above, however, it is used (with $\boxed{(i)}$) to “dimension” the size of the data storage pool.

216 Appendix C: Memory Allocation

1. Place *dd*, the number of the highest data storage register you want allocated, into the display. $1 \leq dd \leq 97$. The number of registers in the uncommitted pool (and therefore *potentially* available for programming) will be $(97 - dd)$.
2. Press **f** **DIM** **(i)**.

There are two ways to review your allocation:

- Press **RCL** **DIM** **(i)** to recall into the stack the number of the highest-allocated data storage register, *dd*. (Programmable.)
- Press **g** **MEM** (as explained above) to view a more complete memory status (*dd uu pp-b*).

Keystrokes

Display

(assuming a *cleared program memory*)*

| | | |
|-----------------------------------|------------|---|
| 1 f DIM (i) | 1 . 0000 | R ₁ , R ₀ , and R _i allocated for data storage. Ninety-six registers are uncommitted; none contain program instructions. |
| g MEM (hold) | 01 96 00-0 | |
| 19 f DIM (i) | 19 . 0000 | R ₁₉ (R ₉) is the highest- numbered data storage register. Seventy-eight registers left in the common pool. |
| RCL DIM (i) | 19 . 0000 | |

Restrictions on Reallocation

Continuous Memory will maintain the configuration you allocate until a new **DIM** **(i)** is executed or Continuous Memory is reset. If you try to allocate a number less than 1, *dd* = 1. If you try to allocate a number greater than 97, **Error 10** results.

* If program memory is not cleared, the number of uncommitted registers (*uu*) is less, owing to allocation of registers to program memory (*pp*). Therefore, *pp* would be > 0 and *b* would vary.

When converting registers, note that:

- You can convert registers from the common pool *only if they are uncommitted*. If, for example, you try to convert registers which contain program instructions, you will get an **Error 10** (insufficient memory).
- You *can* convert *occupied* registers from the data storage pool, *causing a loss of stored data*. An **Error 3** results if you try to address a “lost”—that is, nonexistent—register. Therefore, it is good practice to store data in the lowest-numbered registers first, as these are the last to be converted.

Program Memory

As mentioned before, each register consists of seven bytes of memory. Program instructions use one or two bytes of memory. Most program lines use one byte; those using two bytes are listed on page 218.

The *maximum* programming capacity of the HP 15c is 672 program bytes (96 convertible registers at seven bytes per register). At power-up, memory can hold up to 546 program bytes (78 allocated registers at seven bytes per register).

Automatic Program Memory Reallocation

Within the common register pool, program memory will automatically expand as needed. One uncommitted register at a time, starting with the highest-numbered register available, will be allocated to seven bytes of program memory.

Conversion of Uncommitted Registers to Program Memory

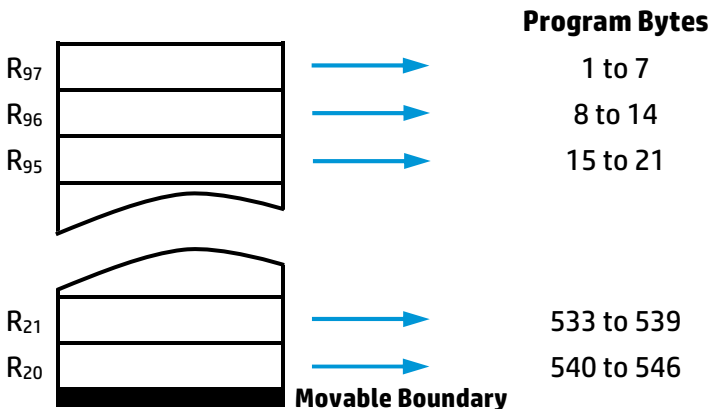

218 Appendix C: Memory Allocation

Your very first program instruction will commit R₉₇ (all seven bytes) from an uncommitted register to a program register. Your eighth program instruction commits R₉₆, and so on, until the boundary of the common pool is encountered. Registers from the data storage pool (at power-up, this is R₁₉ and below) are not available for program memory without reallocating registers using **DIM** (i).

Two-Byte Program Instructions

The following instructions are the only ones which require two bytes of calculator memory. (All others require only one byte.)

| | |
|--|---|
| f LBL ▢ <i>label</i> | f MATRIX {0 to 9} |
| GTO ▢ <i>label</i> | f ↔ {2 to 9, .0 to .9, A to E } |
| GSB ▢ <i>label</i> | f DSE {2 to 9, .0 to .9, A to E } |
| g CF (<i>n</i> or I) | f ISG {2 to 9, .0 to .9, A to E } |
| g SF (<i>n</i> or I) | STO { + , - , × , ÷ } |
| g F? (<i>n</i> or I) | RCL { + , - , × , ÷ } |
| f FIX (<i>n</i> or I) | STO MATRIX { A to E } |
| f SCI (<i>n</i> or I) | STO { A to E , (i)} in User mode |
| f ENG (<i>n</i> or I) | RCL { A to E , (i)} in User mode |
| f SOLVE | STO g (i) |
| f ↔ | RCL g (i) |

Memory Requirements for the Advanced Functions

The four advanced functions require temporary register space from the common register pool.

| Function | Registers Needed |
|---------------|-------------------------------------|
| SOLVE | 5 } 23 if executed 23 } together |
| ↔ | |
| Complex Stack | 5 |
| Matrices | 1 per matrix element |

For **SOLVE** and **∫^x**, allocation and deallocation of the required register space takes place automatically.* Memory is thereby allocated only for the duration of these operations.

Space for the imaginary stack is allocated whenever **f I**, **f Re↔Im**, or **g SF** is pressed. The imaginary stack is deallocated when **g CF** is executed.

Space for matrix registers is not allocated *until you dimension it* (using **DIM**). Reallocation takes place when you redimension a matrix. **MATRIX** 0 dimensions *all* matrices to 0×0 .

* If you should interrupt a **SOLVE** or **∫^x** routine *in progress* by pressing a key, you could deallocate its registers by pressing **g RTN** or **f CLEAR PRGM** in Run mode.

Appendix D

A Detailed Look at SOLVE

Section 13, Finding the Roots of an Equation, includes the basic information needed for the effective use of the SOLVE algorithm. This appendix presents more advanced, supplemental considerations regarding SOLVE.

How SOLVE Works

You will be able to use SOLVE most effectively by having a basic understanding of how the algorithm works.

In the process of searching for a zero of the specified function, the algorithm uses the value of the function at two or three previous estimates to approximate the shape of the function's graph. The algorithm uses this shape to intelligently "predict" a new estimate where the graph might cross the x -axis. The function subroutine is then executed, computing the value of the function at the new estimate.

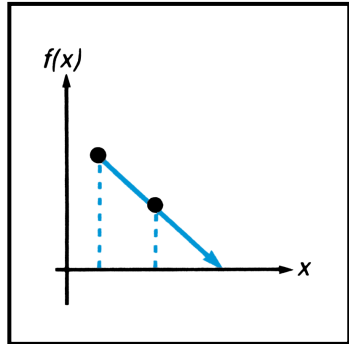

This procedure is performed repeatedly by the SOLVE algorithm.

If any two estimates yield function values with opposite signs, the algorithm presumes that the function's graph must cross the x -axis in at least one place in the interval between these estimates. The interval is systematically narrowed until a root of the equation is found.

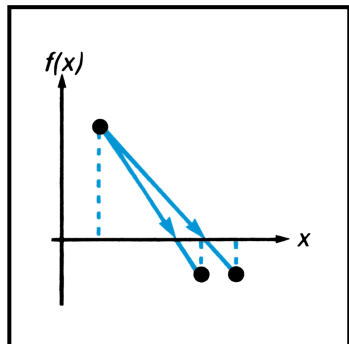

A root is successfully found either if the computed function value is equal to zero or if two estimates, differing by one unit in their last significant digit, give function values having opposite signs. In this case, execution stops and the estimate is displayed.

As discussed in Section 13, page 186, the occurrence of other situations in the iteration process indicates the apparent absence of a function zero. The reason is that there is no way to logically predict a new estimate that is likely to have a function value closer to zero. In such cases, **Error 8** is displayed.

You should note that the initial estimates you provide are used to begin the “prediction” process. By permitting more accurate predictions than might otherwise occur, properly chosen estimates greatly facilitate the determination of the root you seek.

The **SOLVE** algorithm will *always* find a root provided one exists (within the overflow bounds), if any one of four conditions are met:

- Any two estimates have function values with opposite signs.

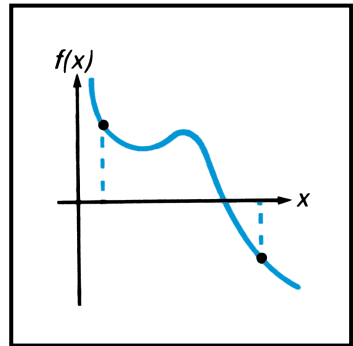

- The function is monotonic, meaning that $f(x)$ either always decreases or else always increases as x is increased.

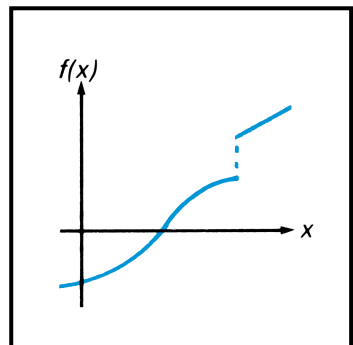

222 Appendix D: A Detailed Look at **SOLVE**

- The function's graph is either convex everywhere or concave everywhere.
- The only local minima and maxima of the function's graph occur singly between adjacent zeros of the function.

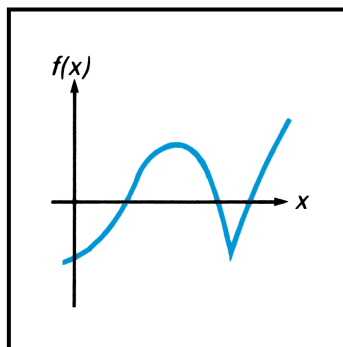
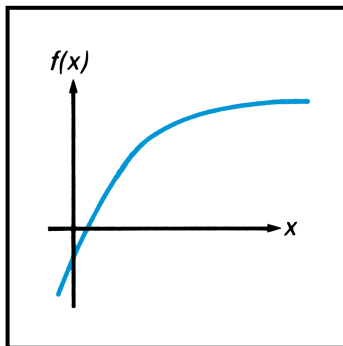

In addition, it is assumed that the **SOLVE** algorithm will not be interrupted by an improper operation.

Accuracy of the Root

When you use the **SOLVE** key to find a root of an equation, the root is found accurately. The displayed root either gives a calculated function value ($f(x)$) exactly equal to zero or else is a 10-digit number virtually adjacent to the place where the function's graph crosses the x -axis. Any such root has an accuracy within two or three units in the 10th significant digit.

In most situations the calculated root is an accurate estimate of the theoretical (infinitely precise) root of the equation. However, certain conditions can cause the finite accuracy of the calculator to give a result that appears to be inconsistent with your theoretical expectation.

If a calculation has a result whose magnitude is smaller than $1.000000000 \times 10^{-99}$, the result is set equal to zero. This effect is referred to as “underflow”. If the subroutine that calculates your function encounters underflow for a range of x and if this affects the value of the function, then a root in this range may be expected to have some inaccuracy. For example, the equation

$$x^4 = 0$$

has a root at $x = 0$. Because of underflow, SOLVE produces a root of 1.5060 -25 (for initial estimates of 1 and 2). As another example, consider the equation

$$1/x^2 = 0$$

whose root is infinite in value. Because of underflow, SOLVE gives a root of 3.1707 49 (for initial estimates of 10 and 20). In each of these examples, the algorithm has found a value of x for which the calculated function value equals zero. By understanding the effect of underflow, you can readily interpret results such as these.

The accuracy of a computed value sometimes can be adversely affected by “round-off” error, by which an infinitely precise number is rounded to 10 significant digits. If your subroutine requires extra precision to properly calculate the function for a range of x , the result obtained by SOLVE may be inaccurate. For example, the equation

$$|x^2 - 5| = 0$$

has a root at $x = \sqrt{5}$. Because no 10-digit number *exactly* equals $\sqrt{5}$, the result of using SOLVE is Error 8 (for any initial estimates) because the function never equals zero nor changes sign. On the other hand, the equation

$$[(|x| + 1) + 10^{15}]^2 = 10^{30}$$

has no roots because the left side of the equation is always greater than the right side. However, because of round-off in the calculation of

$$f(x) = [(|x| + 1) + 10^{15}]^2 - 10^{30},$$

the root 1.0000 is found for initial estimates of 1 and 2. By recognizing situations in which round-off error may influence the operation of **SOLVE**, you can evaluate the results accordingly and perhaps rewrite the function to reduce the effects of round-off.

In a variety of practical applications, the parameters in an equation—or perhaps the equation itself—are merely *approximations*. Physical parameters have an inherent accuracy (or inaccuracy). Mathematical representations of physical processes are only models of those processes, accurate only to the extent that the underlying assumptions are true. An awareness of these and other inaccuracies can be used to your advantage. By structuring your subroutine to return a function value of zero when the calculated value is negligible for practical purposes, you can usually save considerable time in finding a root with **SOLVE**—particularly for cases that would normally take a long time.

Example: Ridget hurlers such as Chuck Fahr can throw a ridget to heights of 105 meters and more. In fact, Fahr’s hurls usually reach a height of 107 meters. How long does it take for his remarkable toss, described on page 184 in Section 13, to reach 107 meters?

Solution: The desired solution is the value of t at which $h = 107$. The subroutine from page 184 calculates the height of the ridget, $h(t)$. This subroutine can be used in a new function subroutine to calculate

$$f(t) = h(t) - 107.$$

The following subroutine calculates $f(t)$. Enter this subroutine after entering the subroutine from page 184:

| Keystrokes | Display | |
|------------------------------|------------------|---------------------------|
| g P/R | 021- 43 32 | Program mode. |
| f LBL B | 022-42 , 21 , 12 | Begin with new label. |
| GSB A | 023- 32 11 | Calculates $h(t)$. |
| 1 | 024- 1 | |
| 0 | 025- 0 | |
| 7 | 026- 7 | Calculates $h(t) - 107$. |
| — | 027- 30 | |
| g RTN | 028- 43 32 | |

In order to find the first time at which the height is 107 meters, use initial estimates of 0 and 1 second and execute **SOLVE** using **B**.

| Keystrokes | Display | |
|--------------------------------|---------|----------------------------------|
| g P/R | | Run mode. |
| 0 ENTER | 0.0000 | } Initial estimates. |
| 1 | 1 | |
| f SOLVE B | 4.1718 | The desired root. |
| R ↓ | 4.1718 | A previous estimate of the root. |
| R ↓ | 0.0000 | Value of $f(t)$ at root. |

It takes 4.1718 seconds for the ridget to reach a height of exactly 107 meters. (It takes approximately two seconds to find this solution.)

However, suppose you assume that the function $h(t)$ is accurate only to the nearest whole meter. You can now change your subroutine to give $f(t) = 0$ whenever the calculated magnitude of $f(t)$ is less than 0.5 meter. Change your subroutine as follows:

| Keystrokes | Display | |
|---------------------------|--------------------|--|
| g P/R | 000- | Program mode. |
| GTO CHS 027 | 027- 30 | Line before RTN instruction. |
| g ABS | 028- 43 16 | Magnitude of $f(t)$. |
| . | 029- 48 | } Accuracy |
| 5 | 030- 5 | |
| g TEST 7 | 031-43,30, 7 | } Test for $x > y$ and return zero if accuracy > magnitude ($0.5 > f(t) $). |
| g CLX | 032- 43 35 | |
| g TEST 0 | 033-43,30, 0 | } Test for $x \neq 0$ and restore $f(t)$ if value is nonzero. |
| g LSTX | 034- 43 36 | |

Execute SOLVE again:

| Keystrokes | Display | |
|--------------------------------|---------|-----------------------------------|
| g P/R | | Run mode. |
| 0 ENTER | 0.0000 | } Initial estimates. |
| 1 | 1 | |
| f SOLVE B | 4.0681 | The desired root. |
| R ↓ | 4.0681 | A previous estimate of the root. |
| R ↓ | 0.0000 | Value of modified $f(t)$ at root. |

After 4.0681 seconds, the ridget is at a height of 107 ± 0.5 meters. This solution, although different from the previous answer, is correct considering the uncertainty of the height equation. (And this solution is found in just under half the time of the earlier solution.)

Interpreting Results

The numbers that SOLVE places in the X-, Y-, and Z-registers help you evaluate the results of the search for a root of your equation.* Even when no root is found, the results are still significant.

When SOLVE finds a root of the specified equation, the root and function values are placed in the X- and Z-registers. A function value of zero is the expected result. However, a nonzero function value is also acceptable because it indicates that the function's graph apparently crosses the x-axis within an infinitesimal distance from the calculated root. In most such cases, the function value will be relatively close to zero.

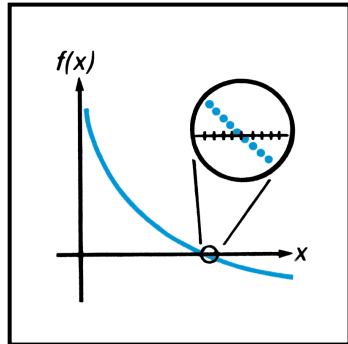

* The number in the T-register is the same number that was left in the Y-register by the final execution of your function subroutine. Generally, this number is not of interest.

Special consideration is required for a different type of situation in which SOLVE finds a root with a nonzero function value. If your function's graph has a discontinuity that crosses the x -axis, SOLVE specifies as a root an x -value adjacent to the discontinuity. This is reasonable because a large change in the function value between two adjacent values of x might be the result of a very rapid, continuous transition. Because this cannot be resolved by the algorithm, the root is displayed for you to interpret.

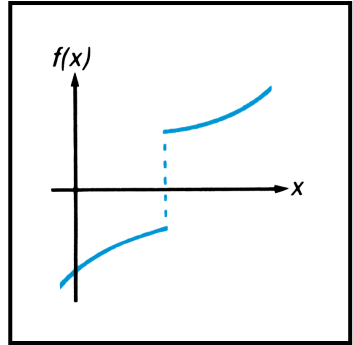

A function may have a *pole*, where its magnitude approaches infinity. If the function value changes sign at a pole, the corresponding value of x looks like a possible root of your equation, just as it would for any other discontinuity crossing the x -axis. However, for such functions, the function value placed into the Z-register when that root is found will be relatively large. If the pole occurs at a value of x that is *exactly* represented with 10 digits, the subroutine may try that value and halt prematurely with an error indication. In this case, the SOLVE operation will not be completed. Of course, this may be avoided by the prudent use of a conditional statement in your subroutine.

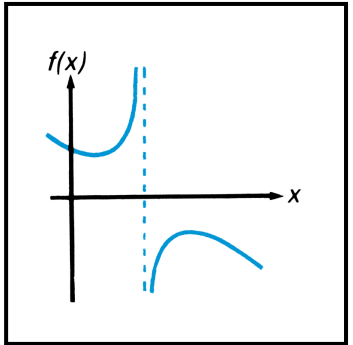

Example: In her analysis of the stresses in a structural component, design consultant Lucy I. Beame has determined that the shear stress can be expressed as

$$Q = \begin{cases} 3x^3 - 45x^2 + 350 & \text{for } 0 < x < 10 \\ 1000 & \text{for } 10 \leq x < 14 \end{cases}$$

where Q is the shear stress in newtons per square meter and x is the distance from one end in meters. Write a subroutine to compute the shear stress for any value of x . Use SOLVE to find the location of zero shear stress.



228 Appendix D: A Detailed Look at **SOLVE**

Solution: The equation for the shear stress for x between 0 and 10 is more efficiently programmed after rewriting it using Horner's method:

$$Q = (3x - 45)x^2 + 350 \quad \text{for } 0 < x < 10.$$

| Keystrokes | Display | |
|---------------------------------------|--------------|------------------------------|
| g P/R | 000- | Program mode. |
| f LBL 2 | 001-42,21, 2 | |
| 1 | 002- 1 | } Test for x range. |
| 0 | 003- 0 | |
| g $x \leq y$ | 004- 43 10 | |
| GTO 9 | 005- 22 9 | Branch for $x \geq 10$. |
| g CLX | 006- 43 35 | |
| 3 | 007- 3 | |
| x | 008- 20 | $3x$. |
| 4 | 009- 4 | |
| 5 | 010- 5 | |
| - | 011- 30 | $(3x - 45)$. |
| x | 012- 20 | |
| x | 013- 20 | $(3x - 45)x^2$. |
| 3 | 014- 3 | |
| 5 | 015- 5 | |
| 0 | 016- 0 | |
| + | 017- 40 | $(3x - 45)x^2 + 350$. |
| g RTN | 018- 43 32 | End subroutine. |
| f LBL 9 | 019-42,21, 9 | Subroutine for $x \geq 10$. |
| EEX | 020- 26 | |
| 3 | 021- 3 | $10^3 = 1000$. |
| g RTN | 022- 43 32 | End subroutine. |

Execute **SOLVE** using initial estimates of 7 and 14 to start at the outer end of the beam and search for a point of zero shear stress.

Keystrokes

G **P/R**

7 **ENTER**

14

f **SOLVE** 2

R↓ **R↓**

Display

7.0000

14

10.0000

1,000.0000

Run mode.

} Initial estimates.

Possible root.

Stress not zero.

The large stress value at the root points out that the **SOLVE** routine has found a discontinuity. This is a place on the beam where the stress quickly changes from negative to positive. Start at the other end of the beam (estimates of 0 and 7) and use **SOLVE** again.

Keystrokes

0 **ENTER**

7

f **SOLVE** 2

R↓ **R↓**

Display

0.0000

7

3.1358

2.0000 -07

} Initial estimates.

Possible root.

Negligible stress.

Beame's beam has zero shear stress at approximately 3.1358 meters and an abrupt change of stress at 10.0000 meters.

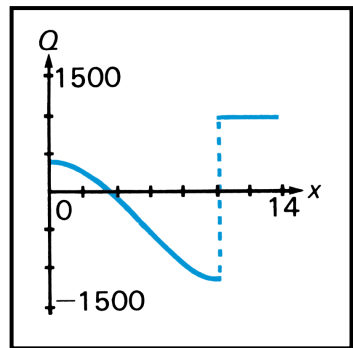

Graph of Q versus x.

When no root is found and **Error 8** is displayed, you can press **←** or any one key to clear the display and observe the estimate at which the function was closest to zero. By also reviewing the numbers in the Y- and Z-registers, you can often determine the nature of the function near the root estimate and use this information constructively.

230 Appendix D: A Detailed Look at **SOLVE**

If the algorithm terminates its search near a local minimum of the function's *magnitude*, clear the **Error 8** display and observe the numbers in the X-, Y-, and Z-registers by rolling down the stack. If the value of the function saved in the Z-register is relatively close to zero, it is possible that a root of your equation has been found—the number returned in the X-register may be a 10-digit number very close to a theoretical root. You can explore this potential minimum further by rolling the stack until the returned estimates are back in the X- and Y-registers and then executing **SOLVE** again using these numbers as initial estimates. If an actual minimum has been found, **Error 8** will again be displayed and the number in the X-register will be approximately the same as before, but possibly closer to the actual location of the minimum.

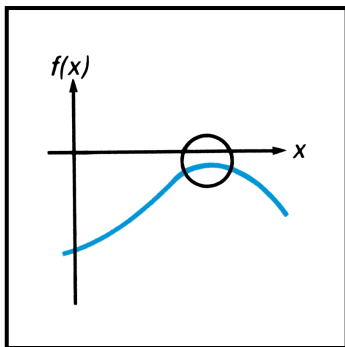

Of course, you may deliberately use **SOLVE** to find the location of a local minimum of the function's magnitude. However, in this case you must be careful to confine the search in the region of the minimum. Remember, **SOLVE** tries hard to find a *zero* of the function.

If the algorithm stops searching and displays **Error 8** because it is working on a horizontal asymptote (when the value of the function is essentially constant for a large range of x), the estimates in X- and Y-registers usually are significantly different from each other. The number in the Z-register is the value of the potential asymptote. If you execute **SOLVE** again using as initial estimates the numbers that were returned in the X- and Y-registers, a horizontal asymptote may again cause **Error 8**, but with numbers in the X- and Y-registers that will differ from the previous numbers. The value of the function in the Z-register would then be about the same as that obtained previously.

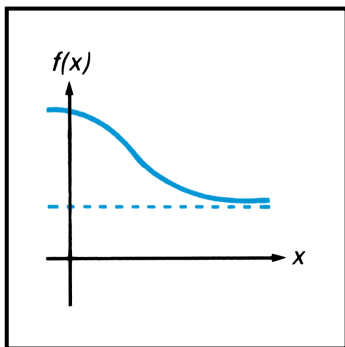

If **Error 8** is displayed as a result of a search that is concentrated in a local “flat” region of the function, the estimates in the X- and Y-registers will be relatively close together or extremely small. Execute **SOLVE** again using for initial estimates the numbers from the X- and Y-registers (or perhaps two numbers somewhat further apart). If the magnitude of the function is neither a minimum nor constant, the algorithm will eventually expand its search and find a more significant result.

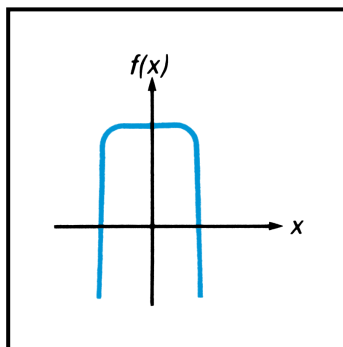

Example: Investigate the behavior of the function

$$f(x) = 3 + e^{-|x|/10} - 2e^{x^2e^{-|x|}}$$

as evaluated in the following subroutine.

| Keystrokes | Display | |
|-------------------------------|----------------|--------------------------------|
| g P/R | 000- | Program mode. |
| f LBL .0 | 001-42, 21, .0 | |
| g ABS | 002- 43 16 | |
| CHS | 003- 16 | |
| e^x | 004- 12 | $e^{- x }$. |
| x↔y | 005- 34 | Bring x-value into X-register. |
| g x² | 006- 43 11 | |
| x | 007- 20 | $x^2e^{- x }$. |
| e^x | 008- 12 | |
| 2 | 009- 2 | |
| x | 010- 20 | |
| CHS | 011- 16 | $-2e^{x^2e^{- x }}$. |
| x↔y | 012- 34 | Bring x-value into X-register. |
| g ABS | 013- 43 16 | |
| CHS | 014- 16 | |
| 1 | 015- 1 | |
| 0 | 016- 0 | |
| ÷ | 017- 10 | $- x /10$. |
| e^x | 018- 12 | |

232 Appendix D: A Detailed Look at **SOLVE**

| Keystrokes | Display | | |
|---------------------|---------|-------|--|
| + | 019- | 40 | $e^{- x /10} - 2e^{x^2}e^{- x }$. |
| 3 | 020- | 3 | |
| + | 021- | 40 | $3 + e^{- x /10} - 2e^{x^2}e^{- x }$. |
| g RTN | 022- | 43 32 | |

Use **SOLVE** with the following *single* initial estimates: 10, 1, and 10^{-20} .

| Keystrokes | Display | | |
|---------------------------------------|----------------|-----|--|
| g P/R | | | Run mode. |
| 10 ENTER | 10.0000 | | Single estimate. |
| f SOLVE .0 | Error 8 | | |
| ← | 455.4335 | | Best x-value. |
| R↓ | 48,026,721.85 | | Previous value. |
| R↓ | 1.0000 | | Function value. |
| g R↑ g R↑ | 455.4335 | | Restore the stack. |
| f SOLVE .0 | Error 8 | | |
| ← | 48,026,721.85 | | Another x-value. |
| R↓ R↓ | 1.0000 | | Same function value (an asymptote). |
| 1 ENTER | 1.0000 | | Single estimate. |
| f SOLVE .0 | Error 8 | | |
| ← | 2.1213 | | Best x-value. |
| R↓ | 2.1471 | | Previous value. |
| R↓ | 0.3788 | | Function value. |
| g R↑ g R↑ | 2.1213 | | Restore the stack. |
| f SOLVE .0 | Error 8 | | |
| ← | 2.1213 | | Same x-value. |
| R↓ R↓ | 0.3788 | | Same function value (a minimum). |
| EEX CHS 20 ENTER | 1.0000 | -20 | Single estimate. |
| f SOLVE .0 | Error 8 | | |
| ← | 1.0000 | -20 | Best x-value. |
| R↓ | 1.1250 | -20 | Previous value. |
| R↓ | 2.0000 | | Function value. |

Keystrokes

| | | | |
|----------|-----------|----------|-----------|
| g | R↑ | g | R↑ |
|----------|-----------|----------|-----------|

| | | |
|----------|--------------|----|
| f | SOLVE | .0 |
|----------|--------------|----|

| |
|----------|
| ← |
|----------|

| |
|-----------|
| R↓ |
|-----------|

| |
|-----------|
| R↓ |
|-----------|

Display

| | | |
|--------|-----|--------------------|
| 1.0000 | -20 | Restore the stack. |
|--------|-----|--------------------|

Error 8

| | | |
|--------|-----|------------------|
| 1.1250 | -20 | Another x-value. |
|--------|-----|------------------|

| | | |
|--------|-----|-----------------|
| 1.5626 | -16 | Previous value. |
|--------|-----|-----------------|

| | | |
|--------|--|----------------------|
| 2.0000 | | Same function value. |
|--------|--|----------------------|

In each of the three cases, **SOLVE** initially searched for a root in a direction suggested by the graph around the initial estimate. Using 10 as the initial estimate, **SOLVE** found the horizontal asymptote (value of 1.0000). Using 1 as the initial estimate, a minimum of 0.3788 at $x = 2.1213$ was found. Using 10^{-20} as the initial estimate, the function was essentially constant (at a value of 2.0000) for the small range of x that was sampled.

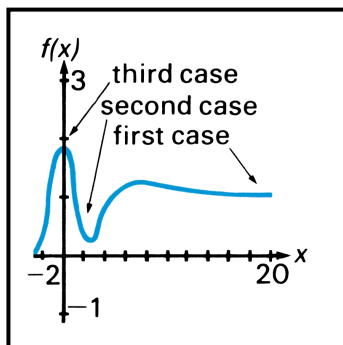

Finding Several Roots

Many equations that you encounter have more than one root. For this reason, you will find it helpful to understand some techniques for finding several roots of an equation.

The simplest method for finding several roots is to direct the root search in different ranges of x where roots may exist. Your initial estimates specify the range that is initially searched. This method was used for all examples in Section 13. You can often find the roots of an equation in this manner.

Another method is known as *deflation*. Deflation is a method by which roots are “eliminated” from an equation. This involves modifying the equation so that the first roots found are no longer roots, but the rest of the roots remain roots.

If a function $f(x)$ has a value of zero at $x = a$, then the new function $f(x)/(x - a)$ will not approach zero in this region (if a is a simple root of $f(x) = 0$). You can use this information to eliminate a known root. Simply add a few program lines at the end of your function subroutine. These

234 Appendix D: A Detailed Look at SOLVE

lines should subtract the known root (to 10 significant digits) from the x -value and divide this difference into the function value. In many cases the root will be a simple one, and the new function will direct SOLVE away from the known root.

On the other hand, the root may be a *multiple root*. A multiple root is one that appears to be present repeatedly, in the following sense: at such a root, not only does the graph of $f(x)$ cross the x -axis, but its slope (and perhaps the next few higher-order derivatives) also equals zero. If the known root of your equation is a multiple root, the root is not eliminated by merely dividing by the factor described above. For example, the equation

$$f(x) = x(x - a)^3 = 0$$

has a multiple root at $x = a$ (with a multiplicity of 3). This root is not eliminated by dividing $f(x)$ by $(x - a)$. But it can be eliminated by dividing by $(x - a)^3$.

Example: Use deflation to help find the roots of

$$60x^4 - 944x^3 + 3003x^2 + 6171x - 2890 = 0.$$

Using Horner's method, this equation can be rewritten in the form

$$\{[(60x - 944)x + 3003]x + 6171\}x - 2890 = 0.$$

Program a subroutine that evaluates the polynomial.

Keystrokes

g P/R
f CLEAR PRGM
f LBL 2
6
0
x
9
4
4
-
x
3
0

Display

000-
000-
001-42,21, 2
002- 6
003- 0
004- 20
005- 9
006- 4
007- 4
008- 30
009- 20
010- 3
011- 0

Program mode.

| Keystrokes | Display |
|---------------------|------------|
| 0 | 012- 0 |
| 3 | 013- 3 |
| + | 014- 40 |
| x | 015- 20 |
| 6 | 016- 6 |
| 1 | 017- 1 |
| 7 | 018- 7 |
| 1 | 019- 1 |
| + | 020- 40 |
| x | 021- 20 |
| 2 | 022- 2 |
| 8 | 023- 8 |
| 9 | 024- 9 |
| 0 | 025- 0 |
| - | 026- 30 |
| g RTN | 027- 43 32 |

In Run mode, key in two large, negative initial estimates (such as -10 and -20) and use **SOLVE** to find the most negative root.

| Keystrokes | Display | |
|----------------------------|------------|----------------------------|
| g P/R | | Run mode. |
| 10 CHS ENTER | -10.0000 | } Initial estimates. |
| 20 CHS | -20 | |
| f SOLVE 2 | -1.6667 | First root. |
| STO 0 | -1.6667 | Stores root for deflation. |
| R↓ R↓ | 4.0000 -06 | Function value near zero. |

Return to Program mode and add instructions to your subroutine to eliminate the root just found.

| Keystrokes | Display | |
|---|-----------|--|
| g P/R | 000- | Program mode. |
| g BST g BST | 026- 30 | Line before RTN . |
| x↔y | 027- 34 | Brings x into X-register. |
| RCL 0 | 028- 45 0 | } Divides by (x - a), where a is known root. |
| - | 029- 30 | |
| ÷ | 030- 10 | |

236 Appendix D: A Detailed Look at `SOLVE`

Now use the same initial estimates to find the next root.

| Keystrokes | Display | |
|--|----------|----------------------------|
| <code>g</code> <code>P/R</code> | 4.0000 | -06 Run mode. |
| 10 <code>CHS</code> <code>ENTER</code> | -10.0000 | } Same initial estimates. |
| 20 <code>CHS</code> | -20 | |
| <code>f</code> <code>SOLVE</code> 2 | 0.4000 | Second root. |
| <code>STO</code> 1 | 0.4000 | Stores root for deflation. |
| <code>R↓</code> <code>R↓</code> | 0.0000 | Deflated function value. |

Now modify your subroutine to eliminate the second root.

| Keystrokes | Display | |
|---|---------|-----------------------------------|
| <code>g</code> <code>P/R</code> | 000- | Program mode. |
| <code>g</code> <code>BST</code> <code>g</code> <code>BST</code> | 030- | 10 Line before <code>RTN</code> . |
| <code>x↔y</code> | 031- | 34 Brings x into X-register. |
| <code>RCL</code> 1 | 032- | 45 1 |
| <code>-</code> | 033- | 30 |
| <code>÷</code> | 034- | 10 |

} Deflation for second root.

Again, use the same initial estimates to find the next root.

| Keystrokes | Display | |
|--|----------|--|
| <code>g</code> <code>P/R</code> | 0.0000 | Run mode. |
| 10 <code>CHS</code> <code>ENTER</code> | -10.0000 | } Same initial estimates. |
| 20 <code>CHS</code> | -20 | |
| <code>f</code> <code>SOLVE</code> 2 | 8.4999 | Third root. |
| <code>STO</code> 2 | 8.4999 | Stores root for deflation. |
| <code>R↓</code> <code>R↓</code> | -1.0929 | -07 Deflated function value near zero. |

Now change your subroutine to eliminate the third root.

| Keystrokes | Display | |
|---|---------|-----------------------------------|
| <code>g</code> <code>P/R</code> | 000- | Program mode. |
| <code>g</code> <code>BST</code> <code>g</code> <code>BST</code> | 034- | 10 Line before <code>RTN</code> . |
| <code>x↔y</code> | 035- | 34 Brings x into X-register. |

Keystrokes

RCL 2

-

÷

Display

036- 45 2

037- 30

038- 10

} Deflation for third root.

Find the fourth root.

Keystrokes

g P/R

10 CHS ENTER

20 CHS

f SOLVE 2

STO 3

R↓ R↓

Display

-1.0929 -07

-10.0000

-20

8.5001

8.5001

-0.0009

} Same initial estimates.

Fourth root.

Stores root for
reference.Deflated function value
near zero.

Using the same initial estimates each time, you have found four roots for this equation involving a fourth-degree polynomial. However, the last two roots are quite close to each other and are actually one root (with a multiplicity of 2). That is why the root was not eliminated when you tried deflation once at this root. (Round-off error causes the original function to have small positive and negative values for values of x between 8.4999 and 8.5001; for $x = 8.5$ the function is exactly zero.)

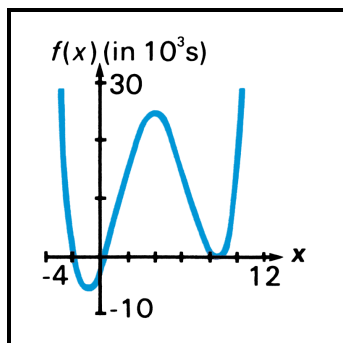
**Graph of $f(x)$**

In general, you will not know in advance the multiplicity of the root you are trying to eliminate. If, after you have attempted to eliminate a root, **SOLVE** finds that same root again, you can proceed in a number of ways:

- Use different initial estimates with the deflated function in an attempt to search for a different root.
- Use deflation again in an attempt to eliminate a multiple root. If you do not know the multiplicity of the root, you may need to repeat this a number of times.

- Examine the behavior of the deflated function at x -values near the known root. If the function's calculated values cross the x -axis smoothly, either another root or a greater multiplicity is indicated.
- Analyze the original function and its derivatives algebraically. It may be possible to determine its behavior for x -values near the known root. (A Taylor series representation, for example, may indicate the multiplicity of a root.)

Limiting the Estimation Time

Occasionally, you may desire to limit the time used by `SOLVE` to find a root. You can use two possible techniques to do this—counting iterations and specifying a tolerance.

Counting Iterations

While searching for a root, `SOLVE` typically samples your function at least a dozen times. Occasionally, `SOLVE` may need to sample it one hundred times or more. (However, `SOLVE` will always stop by itself.) Because your function subroutine is executed once for each estimate that is tried, it can count and limit the number of iterations. An easy way to do this is with an `ISG` instruction to accumulate the number of iterations in the Index register (or other storage register).

If you store an appropriate number in the register before using `SOLVE`, your subroutine can interrupt the `SOLVE` algorithm when the limit is exceeded.

Specifying a Tolerance

You can shorten the time required to find a root by specifying a tolerable inaccuracy for your function. Your subroutine should return a function value of zero if the calculated function value is less than the specified tolerance. This tolerance that you specify should correspond to a value that is negligible for practical purposes or should correspond to the accuracy of the computation. This technique eliminates the time required to define the estimate more accurately than is justified by the problem. (The example on page 224 uses this method.)

For Advanced Information

In the *HP 15c Advanced Functions Handbook*, additional, advanced techniques and applications for using **SOLVE** are presented. These topics include:

- Using **SOLVE** with polynomials.
- Solving a system of equations.
- Finding local extremes of a function.
- Using **SOLVE** for financial problems.
- Using **SOLVE** in Complex mode.
- Solving an equation for its complex roots.

Appendix E

A Detailed Look at \int_y^x

Section 14, Numerical Integration, presented the basic information you need to use \int_y^x . This appendix discusses more intricate aspects of \int_y^x that are of interest if you use \int_y^x often.

How \int_y^x Works

The \int_y^x algorithm calculates the integral of a function $f(x)$ by computing a weighted average of the function's values at many values of x (known as sample points) within the interval of integration. The accuracy of the result of any such sampling process depends on the number of sample points considered: generally, the more sample points, the greater the accuracy. If $f(x)$ could be evaluated at an infinite number of sample points, the algorithm could—neglecting the limitation imposed by the inaccuracy in the calculated function $f(x)$ —provide an exact answer.

Evaluating the function at an infinite number of sample points would take a very long time (namely, forever). However, this is not necessary, since the maximum accuracy of the calculated integral is limited by the accuracy of the calculated function values. Using only a finite number of sample points, the algorithm can calculate an integral that is as accurate as is justified considering the inherent uncertainty in $f(x)$.

The \int_y^x algorithm at first considers only a few sample points, yielding relatively inaccurate approximations. If these approximations are not yet as accurate as the accuracy of $f(x)$ would permit, the algorithm is iterated (that is, repeated) with a larger number of sample points. These iterations continue, using about twice as many sample points each time, until the resulting approximation is as accurate as is justified considering the inherent uncertainty in $f(x)$.

The uncertainty of the final approximation is a number derived from the display format, which specifies the uncertainty for the function.* At the end of each iteration, the algorithm compares the approximation calculated during that iteration with the approximations calculated during two previous iterations. If the difference between any of these three approximations and the other two is less than the uncertainty tolerable in the final approximation, the algorithm terminates, placing the current approximation in the X-register and its uncertainty in the Y-register.

It is extremely unlikely that the errors in each of three successive approximations—that is, the differences between the actual integral and the approximations—would all be larger than the disparity among the approximations themselves. Consequently, the error in the final approximation will be less than its uncertainty.† Although we can't know the error in the final approximation, the error is extremely unlikely to exceed the displayed uncertainty of the approximation. In other words, the uncertainty estimate in the Y-register is an almost certain “upper bound” on the difference between the approximation and the actual integral.

Accuracy, Uncertainty, and Calculation Time

The accuracy of an  approximation does not always change when you increase *by just one* the number of digits specified in the display format, though the uncertainty will decrease. Similarly, the time required to calculate an integral sometimes changes when you change the display format, but sometimes does not.

Example: The Bessel function of the first kind, of order four, can be expressed as

$$J_4(x) = \frac{1}{\pi} \int_0^\pi \cos(4\theta - x \sin \theta) d\theta.$$

* The relationship between the display format, the uncertainty in the function, and the uncertainty in the approximation to its integral are discussed later in this appendix.

† Provided that $f(x)$ does not vary rapidly, a consideration that will be discussed in more detail later in this appendix.

242 Appendix E: A Detailed Look at \int_0^x

Calculate the integral in the expression for $J_4(1)$,

$$\int_0^{\pi} \cos(4\theta - \sin \theta) d\theta.$$



First, switch to Program mode and key in a subroutine that evaluates the function $f(\theta) = \cos(4\theta - \sin \theta)$.

| Keystrokes | Display | |
|---|--------------|---------------|
| \boxed{g} $\boxed{P/R}$ | 000- | Program mode. |
| \boxed{f} CLEAR \boxed{PRGM} | 000- | |
| \boxed{f} \boxed{LBL} 0 | 001-42,21, 0 | |
| 4 | 002- 4 | |
| \boxed{x} | 003- 20 | |
| $\boxed{x}\rightrightarrows\boxed{y}$ | 004- 34 | |
| \boxed{SIN} | 005- 23 | |
| $\boxed{-}$ | 006- 30 | |
| \boxed{COS} | 007- 24 | |
| \boxed{g} \boxed{RTN} | 008- 43 32 | |



Now, switch to Run mode and key the limits of integration into the X- and Y-registers. Be sure the trigonometric mode is set to Radians, and set the display format to \boxed{SCI} 2. Finally, press \boxed{f} \int_0^x 0 to calculate the integral.











| Keystrokes | Display | |
|---------------------------------------|----------|---|
| \boxed{g} $\boxed{P/R}$ | | Run mode. |
| 0 \boxed{ENTER} | 0.0000 | Keys lower limit into Y-register. |
| \boxed{g} $\boxed{\pi}$ | 3.1416 | Keys upper limit into X-register. |
| \boxed{g} \boxed{RAD} | 3.1416 | Sets the trigonometric mode to Radians. |
| \boxed{f} \boxed{SCI} 2 | 3.14 00 | Sets display format to \boxed{SCI} 2. |
| \boxed{f} \int_0^x 0 | 7.79 -03 | Integral approximated in \boxed{SCI} 2. |
| $\boxed{x}\rightrightarrows\boxed{y}$ | 1.45 -03 | Uncertainty of \boxed{SCI} 2 approximation. |

The uncertainty indicates that the displayed digits of the approximation might not include any digits that could be considered accurate. Actually, this approximation is more accurate than its uncertainty indicates.

| Keystrokes | Display | | |
|---|----------------|-----|---|
|  | 7.79 | -03 | Return approximation to display. |
|  (hold) | 7785820888 | | All 10 digits of  approximation. |

The actual value of this integral, correct to five significant digits, is 7.7805×10^{-3} . Therefore, the error in this approximation is about $(7.7858 - 7.7805) \times 10^{-3} = 5.3 \times 10^{-6}$. This error is considerably less than the uncertainty, 1.45×10^{-3} . The uncertainty is only an *upper bound* on the error in the approximation; the actual error will generally be smaller.





Now calculate the integral in  3 and compare the accuracy of the resulting approximation to that of the  2 approximation.

| Keystrokes | Display | | |
|---|----------------|-----|---|
|  | 7.786 | -03 | Changes display format to  . |
|  | 3.142 | 00 | Rolls down stack until upper limit appears in X-register. |
|  | 7.786 | -03 | Integral approximated in  . |
|  | 1.448 | -04 | Uncertainty of  approximation. |
|  | 7.786 | -03 | Returns approximation to display. |
|  (hold) | 7785820888 | | All 10 digits of  approximation. |

All 10 digits of the approximations in **SCI** 2 and **SCI** 3 are identical: the accuracy of the approximation in **SCI** 3 is no better than the accuracy in **SCI** 2 despite the fact that the uncertainty in **SCI** 3 is less than the uncertainty in **SCI** 2. Why is this? Remember that the accuracy of any approximation depends primarily on the number of sample points at which the function $f(x)$ has been evaluated. The  algorithm is iterated with increasing numbers of sample points until the disparity among three successive approximations is less than the uncertainty derived from the display format. After a particular iteration, the disparity among the approximations may already be so much less than the uncertainty that it would still be less if the uncertainty were decreased by a factor of 10. In such cases, if you decreased the uncertainty by specifying one more digit in the display format, the algorithm would not have to consider additional sample points, and the resulting approximation would be identical to the approximation calculated with the larger uncertainty.

If you calculated the two preceding approximations on your calculator, you may have noticed that it did not take any longer to calculate the integral in **SCI** 3 than in **SCI** 2. This is because the time to calculate the integral of a given function depends on the number of sample points at which the function must be evaluated to achieve an approximation of acceptable accuracy. For the **SCI** 3 approximation, the algorithm did not have to consider more sample points than it did in **SCI** 2, so it did not take any longer to calculate the integral.

Often, however, increasing the number of digits in the display format will require evaluating the function at additional sample points, so that calculating the integral will take more time. Now calculate the same integral in **SCI** 4.

| Keystrokes | Display | | |
|---|---------|-----|---|
|  SCI 4 | 7.7858 | -03 | SCI 4 display. |
|   | 3.1416 | 00 | Rolls down stack until upper limit appears in X-register. |
|   0 | 7.7807 | -03 | Integral approximated in SCI 4. |

This approximation took about twice as long as the approximation in `SCI 3` or `SCI 2`. In this case, the algorithm had to evaluate the function at about twice as many sample points as before in order to achieve an approximation of acceptable accuracy. Note, however, that you received a reward for your patience: the accuracy of this approximation is better, by almost two digits, than the accuracy of the approximation calculated using half the number of sample points.

The preceding examples show that repeating the approximation of an integral in a different display format sometimes will give you a more accurate answer, but sometimes it will not. Whether or not the accuracy is changed depends on the particular function, and generally can be determined only by trying it.

Furthermore, if you do get a more accurate answer, it will come at the cost of about double the calculation time. This unavoidable trade-off between accuracy and calculation time is important to keep in mind if you are considering decreasing the uncertainty in hopes of obtaining a more accurate answer.

The time required to calculate the integral of a given function depends not only on the number of digits specified in the display format, but also, to a certain extent on the limits of integration. When the calculation of an integral requires an excessive amount of time, the width of the interval of integration (that is, the difference of the limits) may be too large compared with certain features of the function being integrated. For most problems, however, you need not be concerned about the effects of the limits of integration on the calculation time. These conditions, as well as techniques for dealing with such situations, will be discussed later in this appendix.

Uncertainty and the Display Format

Because of round-off error, the subroutine you write for evaluating $f(x)$ cannot calculate $f(x)$ exactly, but rather calculates

$$\hat{f}(x) = f(x) \pm \delta_1(x),$$

where $\delta_1(x)$ is the uncertainty of $f(x)$ caused by round-off error.

246 Appendix E: A Detailed Look at

If $f(x)$ relates to a physical situation, then the function you would like to integrate is not $f(x)$ but rather

$$F(x) = f(x) \pm \delta_2(x),$$

where $\delta_2(x)$ is the uncertainty associated with $f(x)$ that is caused by the approximation to the actual physical situation.

Since $f(x) = \hat{f}(x) \pm \delta_1(x)$, the function you want to integrate is

$$F(x) = \hat{f}(x) \pm \delta_1(x) \pm \delta_2(x)$$

or

$$F(x) = \hat{f}(x) \pm \delta(x),$$

where $\delta(x)$ is the net uncertainty associated with $\hat{f}(x)$.

Therefore, the integral you want is

$$\begin{aligned} \int_a^b F(x) dx &= \int_a^b [\hat{f}(x) \pm \delta(x)] dx \\ &= \int_a^b \hat{f}(x) dx \pm \int_a^b \delta(x) dx \\ &= I \pm \Delta \end{aligned}$$

where I is the approximation to $\int_a^b F(x) dx$ and Δ is the uncertainty associated with the approximation. The  algorithm places the number I in the X-register and the number Δ in the Y-register.

The uncertainty $\delta(x)$ of $\hat{f}(x)$, the function calculated by your subroutine, is determined as follows. Suppose you consider three significant digits of the function's values to be accurate, so you set the display format to  2. The display would then show only the accurate digits in the mantissa of a function's values: for example,

$$1.23 \quad -04.$$

Since the display format rounds the number in the X-register to the number displayed, this implies that the uncertainty in the function's values is

$$\pm 0.005 \times 10^{-4} = \pm 0.5 \times 10^{-2} \times 10^{-4} = \pm 0.5 \times 10^{-6}.$$

Thus, setting the display format to **SCI** n or **ENG** n , where n is an integer,* implies that the uncertainty in the function's values is

$$\begin{aligned}\delta(x) &= 0.5 \times 10^{-n} \times 10^{m(x)} \\ &= 0.5 \times 10^{-n + m(x)}\end{aligned}$$

In this formula, n is the number of digits specified in the display format and $m(x)$ is the exponent of the function's value at x that would appear if the value were displayed in **SCI** display format.

The uncertainty is proportional to the factor $10^{m(x)}$, which represents the magnitude of the function's value at x . Therefore, **SCI** and **ENG** display formats imply an uncertainty in the function that is *relative* to the function's magnitude.

Similarly, if a function value is displayed in **FIX** n , the rounding of the display implies that the uncertainty in the function's values is

$$\delta(x) = 0.5 \times 10^{-n}.$$

Since this uncertainty is independent of the function's magnitude, **FIX** display format implies an uncertainty that is *absolute*.

Each time the  algorithm samples the function at a value of x , it also derives a sample of $\delta(x)$, the uncertainty of the function's value at x . This is calculated using the number of digits n currently specified in the display format and (if the display format is set to **SCI** or **ENG**) the magnitude $m(x)$ of the function's value at x . The number Δ , the uncertainty of the approximation to the desired integral, is the integral $\delta(x)$:

* Although **SCI** 8 or 9 generally results in the *same display* as **SCI** 7, it will result in a smaller *uncertainty* of a calculated integral. (The same is true for the **ENG** format.) A negative value for n (which can be set by using the Index register) will also affect the uncertainty of an  calculation. The minimum value for n that will affect uncertainty is -6 . A number in R1 less than -6 will be interpreted as -6 .

$$\begin{aligned}\Delta &= \int_a^b \delta(x) dx \\ &= \int_a^b [0.5 \times 10^{-n + m(x)}] dx.\end{aligned}$$

This integral is calculated using the samples of $\delta(x)$ in roughly the same ways that the approximation to the integral of the function is calculated using the samples of $f(x)$.



Because Δ is proportional to the factor 10^{-n} , the uncertainty of an approximation changes by about a factor of 10 for each digit specified in the display format. This will generally not be exact in **SCI** or **ENG** display format, however, because changing the number of digits specified may require that the function be evaluated at different sample points, so that $\delta(x) \sim 10^{m(x)}$ would have different values.

Note that when an integral is approximated in **FIX** display format, $m(x) = 0$ and so the calculated uncertainty in the approximation turns out to be

$$\Delta = 0.5 \times 10^{-n}(b - a).$$

Normally you do not have to determine precisely the uncertainty in the function. (To do so would frequently require a very complicated analysis.) Generally, it's more convenient to use **SCI** or **ENG** display format if the uncertainty in the function's values can be more easily estimated as a *relative* uncertainty. On the other hand, it's more convenient to use **FIX** display format if the uncertainty in the function's values can be more easily estimated as an *absolute* uncertainty. **FIX** display format may be inappropriate to use (leading to peculiar results) when you are integrating a function whose magnitude *and* uncertainty have extremely small values within the interval of integration. Likewise, **SCI** display format may be inappropriate to use (also leading to peculiar results) if the magnitude of the function becomes much smaller than its uncertainty. If the results of calculating an integral seem strange, it may be more appropriate to calculate the integral in the alternate display format.

Conditions That Could Cause Incorrect Results

Although the  algorithm in the HP 15c is one of the best available, in certain situations it—like nearly all algorithms for numerical integration—might give you an incorrect answer. *The possibility of this occurring is extremely remote.* The  algorithm has been designed to give accurate results with almost any smooth function. Only for functions that exhibit *extremely* erratic behavior is there any substantial risk of obtaining an inaccurate answer. Such functions rarely occur in problems related to actual physical situations; when they do, they usually can be recognized and dealt with in a straightforward manner.

As discussed on page 240, the  algorithm samples the function $f(x)$ at various values of x within the interval of integration. By calculating a weighted average of the function's values at the sample points, the algorithm approximates the integral of $f(x)$.

Unfortunately, since all that the algorithm knows about $f(x)$ are its values at the sample points, it cannot distinguish between $f(x)$ and any other function that agrees with $f(x)$ at all the sample points. This situation is depicted in the illustration on the next page, which shows (over a portion of the interval of integration) three of the infinitely many functions whose graphs include the finitely many sample points.

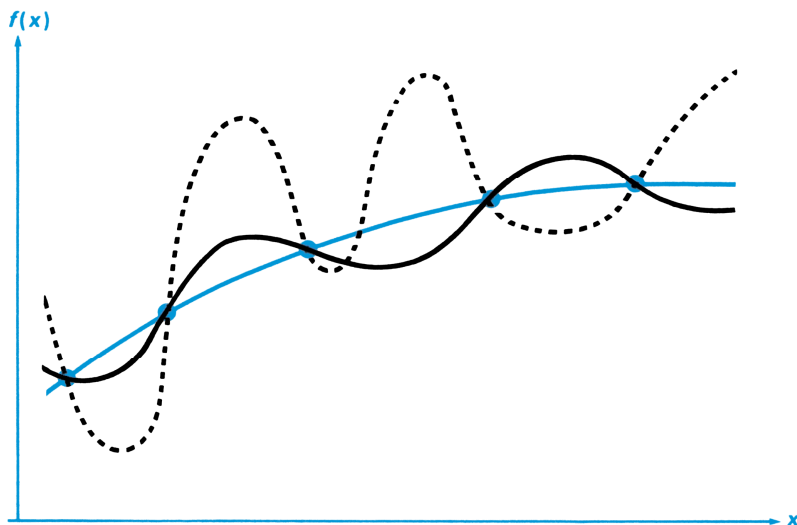

With this number of sample points, the algorithm will calculate the same approximation for the integral of any of the functions shown. The actual integrals of the functions shown with solid lines are about the same, so the approximation will be fairly accurate if $f(x)$ is one of these functions. However, the actual integral of the function shown with a dashed line is quite different from those of the others, so the current approximation will be rather inaccurate if $f(x)$ is this function.









The $\int_a^b f(x) dx$ algorithm comes to know the general behavior of the function by sampling the function at more and more points. If a fluctuation of the function in one region is not unlike the behavior over the rest of the interval of integration, at some iteration the algorithm will likely detect the fluctuation. When this happens, the number of sample points is increased until successive iterations yield approximations that take into account the presence of the most rapid, *but characteristic*, fluctuations.

For example, consider the approximation of









$$\int_0^{\infty} xe^{-x} dx.$$

Since you're evaluating this integral numerically, you might think (naively in this case, as you'll see) that you should represent the upper limit of integration by 10^{99} —which is virtually the largest number you can key into the calculator. Try it and see what happens.

Key in a subroutine that evaluates the function $f(x) = xe^{-x}$.

| Keystrokes | Display | |
|---|--------------|---------------|
|   | 000- | Program mode. |
|   1 | 001-42,21, 1 | |
|  | 002- 16 | |
|  | 003- 12 | |
|  | 004- 20 | |
|   | 005- 43 32 | |

Set the calculator to Run mode. Then set the display format to  3 and key the limits of integration into the X- and Y-registers.

| Keystrokes | Display | |
|---|------------|---|
|   | | Run mode. |
|   3 | | Sets display format to  3. |
| 0  | 0 . 000 00 | Keys lower limit into Y-register. |
|  99 | 1 99 | Keys upper limit into X-register. |
|   1 | 0 . 000 00 | Approximation of integral. |

The answer returned by the calculator is clearly incorrect, since the actual integral of $f(x) = xe^{-x}$ from 0 to ∞ is exactly 1. But the problem is *not* that you represented ∞ by 10^{99} , since the actual integral of this function from 0 to 10^{99} is very close to 1. The reason you got an incorrect answer becomes apparent if you look at the graph of $f(x)$ over the interval of integration:



The graph is a spike very close to the origin. (Actually, to illustrate $f(x)$ the width of the spike has been considerably exaggerated. Shown in actual scale over the interval of integration, the spike would be indistinguishable from the vertical axis of the graph.) Because no sample point happened to discover the spike, the algorithm assumed that $f(x)$ was identically equal to zero throughout the interval of integration. Even if you increased the number of sample points by calculating the integral in [SCI] 9, none of the additional sample points would discover the spike when this particular function is integrated over this particular interval. (Better approaches to problems such as this are mentioned at the end of the next topic, Conditions That Prolong Calculation Time.)

You've seen how the $\int_a^x f(x) dx$ algorithm can give you an incorrect answer when $f(x)$ has a fluctuation somewhere that is very uncharacteristic of the behavior of the function elsewhere. Fortunately, functions exhibiting such aberrations are unusual enough that you are unlikely to have to integrate one unknowingly.

A function that could lead to incorrect results can be identified in simple terms by how rapidly it and its low-order derivatives vary across the interval of integration. Basically, the more rapid the variation in the function or its derivatives, and the lower the order of such rapidly varying derivatives, the less quickly will the $\int_a^x f(x) dx$ algorithm terminate, and the less reliable will the resulting approximation be.

Note that the rapidity of variation in the function (or its low-order derivatives) must be determined with respect to the width of the interval of integration. With a given number of sample points, a function $f(x)$ that has three fluctuations can be better characterized by its samples when these variations are spread out over most of the interval of integration than if they are confined to only a small fraction of the interval. (These two situations are shown in the next two illustrations.) Considering the variations or fluctuations as a type of oscillation in the function, the criterion of interest is the ratio of the period of the oscillations to the width of the interval of integration: the larger this ratio, the more quickly the algorithm will terminate, and the more reliable will be the resulting approximation.

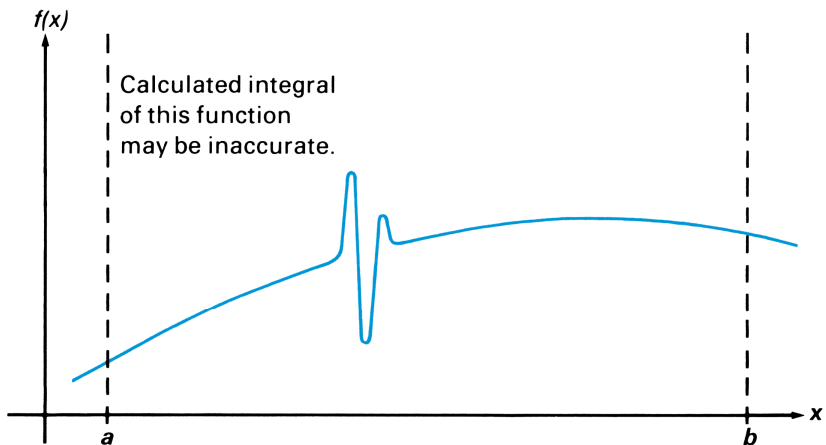
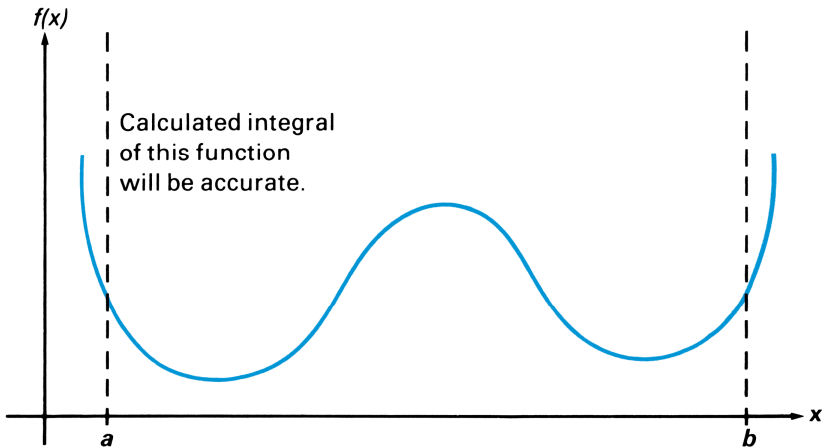





In many cases you will be familiar enough with the function you want to integrate that you'll know whether the function has any quick wiggles relative to the interval of integration. If you're not familiar with the function, and you have reason to suspect that it may cause problems, you can quickly plot a few points by evaluating the function using the subroutine you wrote for that purpose.

If for any reason, after obtaining an approximation to an integral, you have reason to suspect its validity, there's a very simple procedure you can use to verify it: subdivide the interval of integration into two or more adjacent subintervals, integrate the function over each subinterval, then add the resulting approximations. This causes the function to be sampled at a brand new set of sample points, thereby more likely revealing any previously hidden spikes. If the initial approximation was valid, it will equal the sum of the approximations over the subintervals.

Conditions That Prolong Calculation Time

In the preceding example (page 251), you saw that the algorithm gave an incorrect answer because it never detected the spike in the function. This happened because the variation in the function was too quick relative to the width of the interval of integration. If the width of the interval were smaller, you would get the correct answer; but it would take a very long time if the interval were still too wide.

For certain integrals such as the one in that example, calculating the integral may be unduly prolonged because the width of the interval of integration is too large relative to certain features of the functions being integrated. Consider an integral where the interval of integration is wide enough to require excessive calculation time but not so wide that it would be calculated incorrectly. Note that because $f(x) = xe^{-x}$ approaches zero very quickly as x approaches ∞ , the contribution to the integral of the function at large values of x is negligible. Therefore, you can evaluate the integral by replacing ∞ , the upper limit of integration, by a number not so large as 10^{99} , say 10^3 .

| Keystrokes | Display | | |
|---|---------|-----|-----------------------------------|
| 0  | 0.000 | 00 | Keys lower limit into Y-register. |
|  3 | 1 | 03 | Keys upper limit into X-register. |
|   1 | 1.000 | 00 | Approximation to integral. |
|  | 1.824 | -04 | Uncertainty of approximation. |

This is the correct answer, but it took about 5 seconds. To understand why, compare the graph of the function over the interval of integration, which looks about identical to that shown on page 252, to the graph of the function between $x = 0$ and $x = 10$.

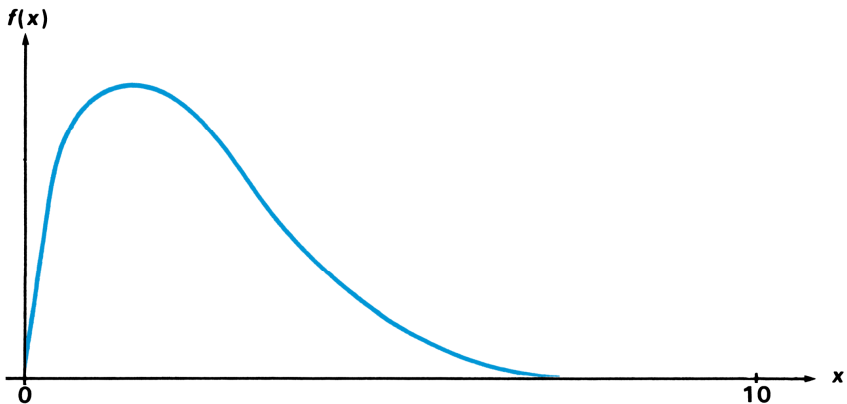

By comparing the two graphs, you can see that the function is “interesting” only at small values of x . At greater values of x , the function is “uninteresting”, since it decreases smoothly and gradually in a very predictable manner.

As discussed earlier, the  algorithm will sample the function with higher densities of sample points until the disparity between successive approximations becomes sufficiently small. In other words, the algorithm samples the function at increasing numbers of sample points until it has sufficient information about the function to provide an approximation that changes insignificantly when further samples are considered.

If the interval of integration were (0, 10) so that the algorithm needed to sample the function only at values where it was interesting but relatively smooth, the sample points after the first few iterations would contribute no new information about the behavior of the function. Therefore, only a few iterations would be necessary before the disparity between successive approximations became sufficiently small that the algorithm could terminate with an approximation of a given accuracy.



On the other hand, if the interval of integration were more like the one shown in the graph on page 252, most of the sample points would capture the function in the region where its slope is not varying much. The few sample points at small values of x would find that values of the function changed appreciably from one iteration to the next. Consequently the function would have to be evaluated at additional sample points before the disparity between successive approximations would become sufficiently small.



In order for the integral to be approximated with the same accuracy over the larger interval as over the smaller interval, the density of the sample points must be the same in the region where the function is interesting. To achieve the same density of sample points, the total number of sample points required over the larger interval is much greater than the number required over the smaller interval. Consequently, several more iterations are required over the larger interval to achieve an approximation with the same accuracy, and therefore calculating the integral requires considerably more time.

Because the calculation time depends on how soon a certain density of sample points is achieved in the region where the function is interesting, the calculation of the integral of any function will be prolonged if the interval of integration includes mostly regions where the function is not interesting. Fortunately, if you must calculate such an integral, you can modify the problem so that the calculation time is considerably reduced. Two such techniques are subdividing the interval of integration and transformation of variables. These methods enable you to change the function or the limits of integration so that the integrand is better behaved over the interval(s) of integration. (These techniques are described in the *HP 15c Advanced Functions Handbook*.)

Obtaining the Current Approximation to an Integral

When the calculation of an integral is requiring more time than you care to wait, you may want to stop and display the current approximation. You can obtain the current approximation, but not its uncertainty.

Pressing  while the HP 15c is calculating an integral halts the calculation, just as it halts the execution of a running program. When you do so, the calculator stops at the current program line in the subroutine you wrote for evaluating the function, and displays the result of executing the preceding program line. Note that after you halt the calculation, the current approximation to the integral is *not* the number in the X-register nor the number in any other stack register. Just as with any program, pressing  again starts the calculation from the program line at which it was stopped.









The  algorithm updates the current approximation and stores it in the LAST X register after evaluating the function at each new sample point. To obtain the current approximation, therefore, simply halt the calculator, single-step if necessary through your function subroutine until the calculator has finished evaluating the function and updating the current approximation. Then recall the contents of the LAST X register, which are updated when the  instruction in the function subroutine is executed.

While the calculator is updating the current approximation, the display is blank and does not show **running**. (While the calculator is executing your function subroutine, **running** is displayed.) Therefore, you might avoid having to single-step through your subroutine by halting the calculator at a moment when the display is blank.

In summary, to obtain the current approximation to an integral, follow the steps below.

1. Press  to halt the calculator, preferably while the display is blank.
2. When the calculator halts, switch to Program mode to check the current program line.
 - If that line contains the subroutine label, return to Run mode and view the LAST X register (step 3).

258 Appendix E: A Detailed Look at

- If any other program line is displayed, return to Run mode and single-step () through the program until you reach a  instruction (keycode 43 32) or line 000 (if there is no ). (Be sure to hold the  key down long enough to view the program line numbers and keycodes.)
3. Press   to view the current approximation. If you want to continue calculating the final approximation, press   . This refills the stack with the current x -value and restarts the calculator.

For Advanced Information

The *HP 15c Advanced Functions Handbook* explores more esoteric aspects of  and its applications. These topics include:

- Accuracy of the function to be integrated.
- Shortening calculation time.
- Calculating difficult integrals.
- Using  in Complex mode.

Appendix F

Batteries, Self-Tests, and Regulatory Information

Batteries

The HP 15c is shipped with two 3 Volt CR2032 lithium batteries. Battery life depends on how the calculator is used. If the calculator is being used to perform operations other than running programs, it uses much less power.

Low-Power Indication

A battery symbol (✱) shown in the lower-left corner of the display when the calculator is on signifies that the available battery power is running low. When the battery symbol begins flashing, replace the batteries as soon as possible to avoid losing data.

Use only fresh batteries. Do not use rechargeable batteries.

Warning



There is a danger of explosion if batteries are incorrectly replaced. Replace only with the same type of battery or with equivalent batteries (as recommended by the manufacturer). Dispose of used batteries according to the manufacturer's instructions. Do not mutilate, puncture, or dispose of batteries in fire. The batteries can burst or explode, releasing hazardous chemicals. Replacement batteries are two Lithium 3V Coin Type CR2032.

Installing New Batteries

To prevent memory loss, never remove two old batteries at the same time. Be sure to remove and replace the batteries one at a time.

To install new batteries, use the following procedure:

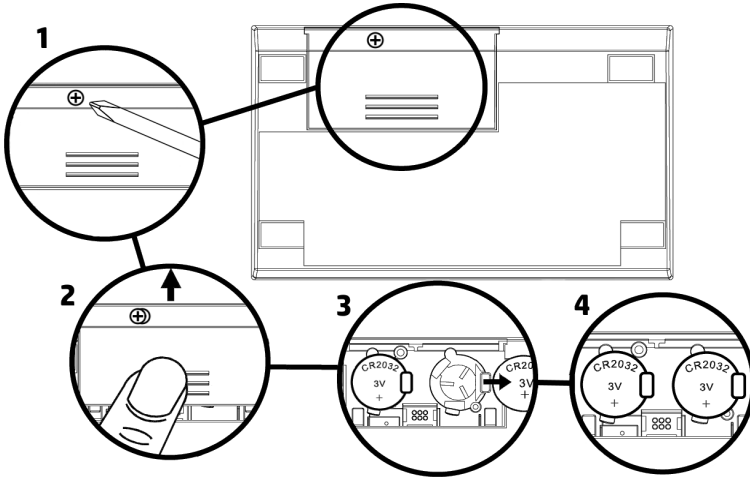

1. With the calculator turned off, using a #0 Phillips screwdriver, loosen the captive screw holding the battery cover in place and pull the screw up.
2. Slide the battery cover off.
3. Remove an old battery.
4. Insert a new CR2032 lithium battery, making sure that the positive sign (+) is facing outward.
5. Remove and insert the other battery as in steps 3 through 4. Make sure that the positive sign (+) on each battery is facing outward.
6. Replace the battery cover.

Note: Be careful not to press any keys while the battery is out of the calculator. If you do so, the contents of Continuous Memory may be lost and keyboard control may be lost (that is, the calculator may not respond to keystrokes).

7. Press **ON** to turn on the power. If for any reason Continuous Memory has been reset (that is, if its contents have been lost), the display will show **Pr Error**. Pressing any key will clear this message.

Verifying Proper Operation (Self-Tests)

If it appears that the calculator will not turn on or otherwise is not operating properly, use the following procedures to access the test system:

1. Turn the calculator off.
2. Press and HOLD the **g** and **ENTER** keys (keep both keys held down for the next step).
3. Press the **ON** key (while both **g** and **ENTER** keys are held down from Step 2 above).
4. Release the **ON** key.
5. Release the **g** and **ENTER** keys.

You will be presented with a main test screen that displays the following:

1 . L 2 . C 3 . H

- Press **1** to perform the LCD test (all LCD segments will be turned on). Press any key to go from one display test screen to the next until you return to the main test screen.
- Press **2** to perform the checksum test and see the firmware revision and copyright messages. Press any key to go from one screen to the next until you return to the main test screen.
- Press **3** to perform the keyboard test. You then need to press EVERY key on the keyboard until all the keys have been pressed at least once (the screen will progressively turn off). You can press the keys in any order and any number of times. Once all the keys have been pressed and the screen is clear, press any key to return to the test screen.

Press **ON** to exit the test system. This will also turn the calculator off.

If an error is detected at any point, it will display an error message.

For a calculator that does not respond to keystrokes or otherwise behaves abnormally, remove the battery cover (see page 260, steps 1 and 2) and use a paper clip or similar object to press and release the recessed RESET button below the left battery, and then try turning the calculator back on. This should reset the calculator and restore the default configuration.

Legal Notice

This manual and any examples contained herein are provided “as is” and are subject to change without notice.

Manufacturer* makes no warranty of any kind with regard to this manual, including, but not limited to, the implied warranties of merchantability, non-infringement and fitness for a particular purpose. In this regard, manufacturer shall not be liable for technical or editorial errors or omissions contained in the manual.

Manufacturer shall not be liable for any errors or for incidental or consequential damages in connection with the furnishing, performance, or use of this manual or the examples contained herein.

Reproduction, adaptation, or translation of this manual is prohibited without prior written permission of manufacturer, except as allowed under the copyright laws.

*** Manufacturer:**

MORAVIA Consulting spol. s r.o.
Olomoucká 83
627 00 Brno
Czech Republic
www.hpcalcs.com

Customer Care

If you need assistance with the warranty, please refer to the warranty information on the web at:

www.hpcalcs.com/support

Regulatory Information and Environmental Limits

For regulatory information and environmental limits please visit:

www.hpcalcs.com/support

Limited Hardware Warranty

This manufacturer Limited Warranty gives you, the end-user customer, express limited warranty rights from the manufacturer. Please refer to the web site www.hpcalcs.com/support for an extensive description of your limited warranty entitlements.

In addition, you may also have other legal rights under applicable local law or special written agreement with the manufacturer.

Duration: 12 months total (may vary by region; please visit www.hpcalcs.com/support for the latest information).



www.hpcalcs.com/support

Federal Communications Commission Notice

This equipment has been tested and found to comply with the limits for a Class B digital device, pursuant to Part 15 of the FCC Rules. These limits are designed to provide reasonable protection against harmful interference in a residential installation. This equipment generates, uses, and can radiate radio frequency energy and, if not installed and used in accordance with the instructions, may cause harmful interference to radio communications. However, there is no guarantee that interference will not occur in a particular installation. If this equipment does cause harmful interference to radio or television reception, which can be determined by turning the equipment off and on, the user is encouraged to try to correct the interference by one or more of the following measures:

- Reorient or relocate the receiving antenna.
- Increase the separation between the equipment and the receiver.
- Connect the equipment into an outlet on a circuit different from that to which the receiver is connected.
- Consult the dealer or an experienced radio or television technician for help.

Modifications

The FCC requires the user to be notified that any changes or modifications made to this device that are not expressly approved by HP Inc. may void the user's authority to operate the equipment.

Declaration of Conformity for Products Marked with FCC Logo, United States Only

This device complies with Part 15 of the FCC Rules. Operation is subject to the following two conditions: (1) this device may not cause harmful interference, and (2) this device must accept any interference received, including interference that may cause undesired operation. If you have questions about the product that are not related to this declaration, please visit:

www.hpcalcs.com/support

Canadian Notice

This Class B digital apparatus meets all requirements of the Canadian Interference-Causing Equipment Regulations.

Avis Canadien

Cet appareil numérique de la classe B respecte toutes les exigences du Règlement sur le matériel brouilleur du Canada.

For Australia Only

WARNING!

- KEEP BATTERIES OUT OF REACH OF CHILDREN.
- Never allow children to replace button batteries on any device.
- Swallowing may lead to severe or fatal injuries in as little as 2 hours or less due to chemical burns and potential perforation of the esophagus.
- **If it is suspected a button/coin battery has been swallowed or otherwise placed inside any part of the body, a person should contact the Australian Poisons Information Centre on 13 11 26 immediately for 24/7 fast, expert advice. If your child is having any difficulty breathing, contact 000.**
- Examine devices and make sure the battery compartment is correctly secured e.g. that the screw (or another mechanical fastener) is tightened. Do not use if compartment is not secure.
- Dispose of used button/coin batteries immediately and safely. A battery can still be dangerous even when it can no longer operate the device. Place sticky tape around both sides of the battery and dispose of it immediately in an outside bin, out of reach of children, and recycle safely.
- Tell others about the risk associated with button batteries and how to keep their children safe.

Perchlorate Material—Special Handling May Apply

This calculator’s memory backup batteries may contain perchlorate and may require special handling when recycled or disposed in California.

Chemical Substances

HP is committed to providing our customers with information about the chemical substances in our products as needed to comply with legal requirements such as REACH (Regulation EC No 1907/2006 of the European Parliament and the Council).

Disposal of Waste Equipment by Users in Private Households in the European Union

This symbol on the product or on its packaging indicates that this product must not be disposed of with your other household waste. Instead, it is your responsibility to dispose of your waste equipment by handing it over to a designated collection point for the recycling of waste electrical and electronic equipment. The separate collection and recycling of your waste equipment at the time of disposal will help to conserve natural resources and ensure that it is recycled in a manner that protects human health and the environment. For more information about where you can drop off your waste equipment for recycling, please contact your local city office, your household waste disposal service or the shop where you purchased the product.

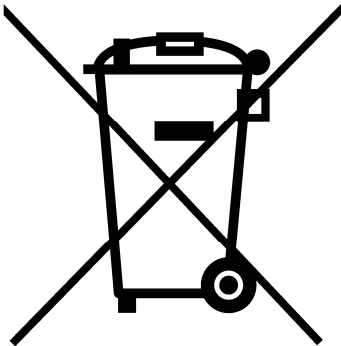



European Union Regulatory Notice

Products bearing the CE marking comply with the following EU Directives:

- Low Voltage Directive 2006/95/EC
- EMC Directive 2004/108/EC
- Ecodesign Directive 2009/125/EC, where applicable

Compliance with these directives implies conformity to applicable harmonized European standards (European Norms) that are listed in the EU Declaration of Conformity issued by HP for this product or product family and available (in English only) either within the product documentation or at the following web site: www.hpcalcs.com/support

The compliance is indicated by one of the following conformity markings placed on the product:

| | |
|---|--|
|  | For non-telecommunications products and for EU harmonized telecommunications products, such as Bluetooth® within power class below 10mW. |
|  | For EU non-harmonized telecommunications products (If applicable, a 4-digit notified body number is inserted between CE and !). |

Please refer to the regulatory label provided on the product.

Japanese Notice

この装置は、クラスB情報技術装置です。この装置は、家庭環境で使用することを目的としていますが、この装置がラジオやテレビジョン受信機に近接して使用されると、受信障害を引き起こすことがあります。

取扱説明書に従って正しい取り扱いをして下さい。 VCCI—B

Korean Notice

| | |
|-----------------------|---|
| B급 기기 (가정용 방송통신기기) | 이 기기는 가정용 (B급)으로 전자파적합등록을 한 기기로서 주로 가정에서 사용하는 것을 목적으로 하며, 모든 지역에서 사용할 수 있습니다. |
|-----------------------|---|

Chinese Notice

产品中有毒有害物质或元素的名称及含量
根据中国《电子信息产品污染控制管理办法》

| 部件名称 | 有毒有害物质或元素 | | | | | |
|--------|-----------|--------|--------|-----------------|---------------|------------------|
| | 铅 (Pb) | 汞 (Hg) | 镉 (Cd) | 六价铬 (Cr(VI)) | 多溴联苯 (PBB) | 多溴二联苯醚 (PBDE) |
| PCA | X | O | O | O | O | O |
| 外觀象 字鍵 | O | O | O | O | O | O |

O: 表示该有毒有害物质在该部件所有均质材料中的含量均在SJ/T 11363-2006标准规定的限量要求以下。

X: 表示该有毒有害物质至少在该部件的某一均质材料中的含量超出SJ/T11363-2006标准规定的限量要求。

表中标有“X”的所有部件都符合欧盟 RoHS 法规

“欧洲议会和欧盟理事会2003年1月27日关于电子电器设备中限制使用某些有害物质的2002/95/EC号指令”

注：环保使用期限的参考标识取决于产品正常工作的温度和湿度等条件

Appendix G

Differences Between the HP 15c CE and HP-15C

Performance

The CPU of the HP 15c CE is more than 200 times faster than the CPU in the original HP-15C. Due to overhead, real-world performance does not increase by this much, but typical operations are 10–20 times faster than on the HP-15C.

If a program written for the original HP-15C relies on special timing, for example if the expected run-time of a program gives the user a fixed time to react, then that program will need to be slowed down on the HP 15c CE, possibly by the addition of **PSE** (pause) steps or by making loops repeat more times.

Memory

The HP 15c CE provides 50% more memory than the HP-15C—672 bytes instead of 448 bytes. This increases the number of allocatable storage registers from 64 to 96.

This means the **g** **MEM** function, which displays the available registers and their allocation, will appear different due to the increased memory on the HP 15c CE. The default allocation shows “19 78 00–0” instead of “19 46 0–0”.

The original HP-15C was limited by memory to a maximum matrix size of 8×8 . Despite the increased memory of the HP 15c CE, the limit of 8×8 remains for matrix inverse, determinant, and division.

Battery Usage

The greater performance means greater battery requirements, too. The HP 15c CE uses two lithium batteries instead of three alkaline or silver-oxide batteries in order to provide sufficient current.

The low-power indicator is designed to give you plenty of warning before the calculator stops functioning, checking periodically after keystrokes to see whether the batteries need replacement.

To minimize power consumption, the calculator normally operates in a low-power mode, with the processor running at a slow speed. When running user programs (including integration), the calculator switches the processor to full speed, which increases the demand on the batteries. However, when the low battery indicator comes on, the calculator will only run at the slow speed to avoid overloading the batteries.

Most programs will complete in a second or less, often much less, and appear to be instantaneous. But if your program is designed to run for very long run times (i.e., exceeding 10 seconds), it is possible that before the low battery indicator comes on, you can deplete the batteries below a safe level to maintain memory and some of your programs and/or data could be lost.

To avoid this, be sure to have new or relatively fresh batteries installed before executing user programs with extended run times.

Self-Tests

Because of the different hardware platform, the HP 15c CE has a different self-test system than the HP-15C had. This means the self-test operations provided on the original HP-15C no longer give valid results.

The new self-test procedures are described in Appendix F.

Display

The original HP-15C had fixed display contrast. The contrast on the HP 15c CE can be adjusted by following the steps on page 63.

Appendix H

Known Limitations

The following three cases describe limitations where the HP 15c may not work as expected.

GSB I With Negative Number

The HP 15c supports indirect branching, by storing either a label index (as a positive number) or a line number (as a negative number) in R_i, and then calling **GTO I**. However, when instead branching to a subroutine with **GSB I**, only a label index (a positive number) is supported. Using a negative number (for a line number) will result in unexpected behavior.

Conditional as Last Line in Program

When the last line of a program is a conditional test that could skip the next line (either an explicit conditional, such as **x=0**, or an implicit conditional, such as the “User” **RCL A** with a matrix as described on page 176), unexpected behavior will result. To avoid this, put a **RTN** as the last line in the program after the conditional statement.

CHS and Stack Lift

Normally, after digit entry termination, **CHS** enables stack lift, as described in Appendix B. However, if the value in the X-register is 0, stack lift will not be enabled.

Function Summary and Index

| | |
|---|------------|
| ON | 272 |
| Complex Functions | 272 |
| Conversions | 273 |
| Digit Entry | 273 |
| Display Control..... | 273 |
| Hyperbolic Functions | 273 |
| Index Register Control | 274 |
| Logarithmic and Exponential Functions | 274 |
| Mathematics | 274 |
| Matrix Functions | 274 |
| Number Alteration | 276 |
| Percentage..... | 276 |
| Prefix Keys | 276 |
| Probability..... | 276 |
| Stack Manipulation | 277 |
| Statistics | 277 |
| Storage..... | 278 |
| Trigonometry | 278 |

ON

ON Turns the calculator's display on and off (**page 18**). It is also used in resetting Continuous Memory (**page 63**), changing the digit separator (**page 61**), and in various tests of the calculator's operation (**page 261**).

Complex Functions

Re \leftrightarrow Im Real exchange imaginary. Activates Complex mode (establishing an imaginary stack) and exchanges the real and imaginary X-registers (**page 124**).

I Used to enter complex numbers. Activates Complex mode (establishing an imaginary stack) (**page 121**). Also used with **DIM** to indirectly dimension matrices (**page 174**). (For Index register functions, refer to Index Register Control keys, page 274.)

(i) Displays the contents of the imaginary X-register while the key is held **(page 124)**.

[SF] 8 Sets flag 8, which activates Complex mode **(page 121)**.

[CF] 8 Clears flag 8, deactivating Complex mode **(page 121)**.

Conversions

↔R Converts polar magnitude r and angle θ in X- and Y-registers respectively to rectangular x - and y -coordinates **(page 31)**. For operation in Complex mode, refer to **page 134**.

↔P Converts x , y rectangular coordinates placed in X- and Y-registers respectively to polar magnitude r and angle θ **(page 30)**. For operation in Complex mode, refer to **page 134**.

↔HMS Converts decimal hours (or degrees) to hours, minutes, seconds (or degrees, minutes, seconds) **(page 27)**.

↔H Converts hours, minutes, seconds (or degrees, minutes, seconds) to decimal hours (or degrees) **(page 27)**.

↔RAD Converts degrees to radians **(page 27)**.

↔DEG Converts radians to degrees **(page 27)**.

Digit Entry

[ENTER] Enters a copy of number in X-register (display) into Y-register; used to separate multiple number entries **(pages 22, 37)**.

[CHS] Change sign of number or exponent of 10 in display **(pages 19, 124)**.

[EEX] Enter exponent; next digits keyed in are exponents of 10 **(page 19)**.

[0] through **[9]** digit keys **(page 22)**.

[.] Decimal point **(page 22)**.

Display Control

[FIX] Selects fixed point display mode **(page 58)**.

[SCI] Selects scientific notation display mode **(page 58)**.

[ENG] Selects engineering notation display mode **(page 59)**.

Mantissa. Pressing **[f]** **CLEAR** **[PREFIX]** displays all 10 digits of the number in the X-register as long as the **[PREFIX]** key is held down **(page 60)**. It also clears any partial key sequences **(page 19)**.

Hyperbolic Functions

[HYP] **[SIN]**,
[HYP] **[COS]**,
[HYP] **[TAN]** Compute hyperbolic sine, hyperbolic cosine, or hyperbolic tangent, respectively **(page 28)**.

$\boxed{\text{HYP}^{-1}} \boxed{\text{SIN}}$,
 $\boxed{\text{HYP}^{-1}} \boxed{\text{COS}}$,
 $\boxed{\text{HYP}^{-1}} \boxed{\text{TAN}}$ Compute
 inverse hyperbolic sine,
 inverse hyperbolic
 cosine, or inverse
 hyperbolic tangent,
 respectively (**page 28**).

Index Register Control

$\boxed{\text{I}}$ Index register (R_i).
 Storage register for:
 indirect program
 execution—branching
 with $\boxed{\text{GTO}}$ and $\boxed{\text{GSB}}$,
 looping with $\boxed{\text{ISG}}$ and
 $\boxed{\text{DSE}}$ —indirect flag
 control, and indirect
 display format control
(page 107). Also used to
 enter complex numbers
 and activate Complex
 mode (**page 121**).

$\boxed{\text{(i)}}$ Indirect operations.
 Used to address *another*
 storage register *through*
 R_i for purposes of
 storage, recall, storage,
 arithmetic, and program
 loop control (**page 107**).
 Also used with $\boxed{\text{DIM}}$ to
 allocate storage
 registers (**page 215**).

Logarithmic and Exponential Functions

$\boxed{\text{LN}}$ Computes natural
 logarithm (**page 28**).

$\boxed{e^x}$ Natural
 antilogarithm. Raises e
 to power of number in
 display (X-register)
(page 28).

$\boxed{\text{LOG}}$ Computes
 common logarithm
 (base 10) (**page 28**).

$\boxed{10^x}$ Common
 antilogarithm. Raises 10
 to power of number in
 display (X-register)
(page 28).

$\boxed{y^x}$ Raises number in
 Y-register to power of
 number in display
 (X-register) (enter y ,
 then x). Causes the
 stack to drop (**page 29**).

Mathematics

$\boxed{-}$ $\boxed{+}$ $\boxed{\times}$ $\boxed{\div}$
 Arithmetic operators;
 cause the stack to drop
(page 29).

$\boxed{\sqrt{x}}$ Computes square
 root x (**page 25**).

$\boxed{x^2}$ Computes
 the square of x
(page 25).

$\boxed{x!}$ Calculates the
 factorial ($n!$) of x or
 Gamma function (Γ) of
 $(1 + x)$ (**page 25**).

$\boxed{1/x}$ Computes reciprocal
(page 25). (For matrix
 use, refer to Matrix
 Functions, page 275.)

$\boxed{\pi}$ Places value of π in
 display (**page 24**).

$\boxed{\text{SOLVE}}$ Solves for real
 root of a function $f(x)$,
 with the expression for
 $f(x)$ defined by the user
 in a labeled subroutine
(page 180).

$\boxed{\int}$ Integrate. Computes
 the definite integral of
 $f(x)$, with the expression
 $f(x)$ defined by the user
 in a labeled subroutine
(page 194).

Matrix Functions

$\boxed{\text{DIM}}$ Dimensions a
 matrix of a given name
 $\{\boxed{\text{A}}$ to $\boxed{\text{E}}$, $\boxed{\text{I}}\}$
(page 141).

RESULT Designates the matrix into which the result of certain matrix operations is placed (page 148).

USER User mode. Row and column numbers in R_0 and R_1 are automatically incremented each time **STO** or **RCL** {**A** to **E**, **(i)**} is pressed (page 144).

STO and **RCL** {**A** to **E**, **(i)**} Stores or recalls matrix elements using the row and column numbers in R_0 and R_1 (pages 144, 146).

STO **g** and **RCL** **g** {**A** to **E**, **(i)**} Stores or recalls matrix elements using the row and column numbers in the Y- and X-registers (page 146).

STO and **RCL** **MATRIX** {**A** to **E**} Stores or recalls matrices for the specified matrix (pages 142, 147).

STO and **RCL** **RESULT** Stores or recalls descriptor of the result matrix (page 148).

RCL **DIM** {**A** through **E**, **I**} Recalls the dimensions of the given matrix into the Y- (row) and X- (column) registers (page 142).

$1/x$ Inverts the matrix whose descriptor is displayed and places the result in the specified result matrix. The descriptor of the result matrix is then displayed (page 150).

+, **-**, **×** Adds, subtracts, or multiplies the corresponding elements of two matrices or of one matrix and a scalar. Stores in result matrix (pages 152–155).

\div For two matrices, multiplies inverse of matrix in X by matrix in Y. For only one matrix: if matrix in Y, divides all elements of matrix by scalar in X; if matrix in X, multiplies each element of inverse of matrix by the scalar in Y. Stores in result matrix (pages 152–155).

CHS changes sign of all elements in matrix specified in X-register (page 150).

MATRIX {0 through 9} Matrix operations.

MATRIX 0 Dimensions all matrices to 0×0 (page 143).

MATRIX 1 Sets row and column numbers in R_0 and R_1 to 1 (page 143).

MATRIX 2 Complex transform: Z^P to \tilde{Z} (page 164).

MATRIX 3 Inverse complex transform. \tilde{Z} to Z^P (page 164).

MATRIX 4 Transpose X to X^T (page 150).

MATRIX 5 Transpose multiply: Y and X to $Y^T X$ (page 154).

MATRIX 6 Calculates residuals in result matrix (page 159).

MATRIX 7 Calculates row norm of matrix specified in X-register (page 150).

MATRIX 8 Calculates Frobenius norm of matrix specified in X-register **(page 150)**.

MATRIX 9 Calculates determinant of matrix specified in X-register (also does *LU* decomposition of the matrix) **(page 150)**.

Cy,x Transforms matrix stored in “partitioned form” (Z^P) to “complex form” (Z^C) **(page 162)**.

Py,x Transforms matrix stored in “complex form” (Z^C) to “partitioned form” (Z^P) **(page 162)**.

x=0 **TEST** 0 **TEST** 5

TEST 6 Conditional tests for matrix descriptors in the X- or X- and Y-registers. **x=0** and **TEST** 0 ($x \neq 0$) test the quantity in the X-register for zero. Matrix descriptors are considered nonzero. **TEST** 5 ($x = y$) and **TEST** 6 ($x \neq y$) test if the descriptors in X and Y are the same. The result affects program execution: skip (one line) if false **(page 174)**.

Number Alteration

ABS Yields absolute value of number in display **(page 24)**.

FRAC Leaves only fractional portion of number in display (X-register) by truncating integer portion **(page 24)**.

INT Leaves only integer portion of number in display (X-register) by truncating fractional portion **(page 24)**.

RND Rounds mantissa of entire (10-digit) number in X-register to match display format **(page 24)**.

Percentage

% Percent. Computes $x\%$ (value in display) of number in the Y-register **(page 29)**. Unlike most two-number functions, **%** does not drop the stack.

Δ% Percent difference. Computes percent of change between number in Y-register and number in display **(page 30)**. Does not drop the stack.

Prefix Keys

f Pressed before a function key to select the gold function printed above that key **(page 18)**.

g Pressed before a function key to select the blue function printed below that key **(page 18)**.

For other prefix keys, refer to Display Control keys (page 273), Storage keys (page 278), and the Programming Summary and Index (page 278).

CLEAR **PREFIX** Cancels any prefix keystrokes and partially entered instructions such as **f** **SCI** **(page 19)**. Also displays the complete 10-digit mantissa of the number in the display **(page 60)**.

Probability

Cy,x Combination. Computes the number of possible sets of y different items taken x at a time, and causes the stack to drop **(page 47)**.

(For matrix use, refer to Matrix Functions keys, page 276.)

[P_{y,x}] Permutation. Computes the number of possible different arrangements of y different items taken x at a time, and causes the stack to drop (**page 47**). (For matrix use, refer to Matrix Functions keys, page 276.)

Stack Manipulation

[X \leftrightarrow Y] Exchanges contents of X- and Y-stack registers (**page 34**).

[X \leftrightarrow] X-register exchange. Exchanges contents of X-register with those of any other named storage register. Used with **[I]**, **[i]**, digit, or **[\bullet]** digit address (**page 42**).

[Re \leftrightarrow Im] Real exchange imaginary. Exchanges the contents of the real and imaginary X-registers and activates Complex mode (**page 124**).

[R \downarrow] Rolls down contents of stack (**page 34**).

[R \uparrow] Rolls up contents of stack (**page 34**).

[CLX] Clears contents of display (X-register) to zero (**page 21**).

[\leftarrow] In Run mode: removes the last digit keyed in, or clears the display (if digit entry has been terminated) (**page 21**).

Statistics

[$\Sigma+$] Accumulates numbers from X- and Y-registers into storage registers R₂ through R₇ (**page 49**).

[RCL] [$\Sigma+$] Copies Σy from R₃ and Σx from R₅ into the X-register and the Y-register, respectively (**page 50**).

[$\Sigma-$] Removes numbers in X- and Y-registers from storage registers R₂ through R₇ for correcting **[$\Sigma+$]** accumulations (**page 52**).

[\bar{x}] Computes mean of x - and y -values accumulated by **[$\Sigma+$]** (**page 53**).

[s] Computes sample standard deviations of x - and y -values accumulated by **[$\Sigma+$]** (**page 53**).

[\hat{y}_r] Linear estimate and correlation coefficient. Computes estimated value of y (\hat{y}) for a given value of x by least squares method and places result in X-register. Computes the correlation coefficient, r , of the accumulated data and places result in Y-register (**page 55**).

[LR] Linear Regression. Computes the y -intercept and slope for the linear function best approximating the accumulated data. The value of the y -intercept is placed in the X-register; the value of the slope is placed in the Y-register (**page 54**).

[RAN#] Random number. Yields a pseudorandom number as generated from a seed stored using **[STO] [RAN#]** (**page 48**).

CLEAR [Σ] Clears contents of the statistics registers (R₂ to R₇) (**page 49**).

Storage

[STO] Store. Stores a copy of a number into the storage register specified {0 to 9, .0 to .9, **[I]**, **[i]**} (**page 42**). Also used for storage register arithmetic: new register contents = old register contents {**[+]**, **[-]**, **[×]**, **[÷]**} display (**page 44**).

[RCL] Recall. Recalls a copy of the number from the storage register specified {0 to 9, .0 to .9, **[I]**, **[i]**} (**page 42**). Also used for storage register arithmetic: new display = old display {**[+]**, **[-]**, **[×]**, **[÷]**} register contents (**page 44**).

CLEAR [REG] Clears contents of all storage registers to zero (**page 43**).

[LSTX] Recalls into the display the number present before the previous operation (**page 35**).

Trigonometry

[DEG] Sets decimal Degrees mode for trigonometric functions—indicated by absence of **GRAD** or **RAD** annunciator (**page 26**). Not operative for complex trigonometry.

[RAD] Sets Radians mode for trigonometric functions—indicated by **RAD** annunciator (**page 26**).

[GRD] Sets Grads mode for trigonometric functions—indicated by **GRAD** annunciator (**page 26**). Not operative for complex trigonometry.

[SIN], **[COS]**, **[TAN]** Compute sine, cosine, or tangent, respectively, of number in display (X-register) (**page 26**).

[SIN⁻¹], **[COS⁻¹]**, **[TAN⁻¹]** Compute arcsine, arccosine, or arctangent, respectively, of number in display (X-register) (**page 26**).

Programming Summary and Index

[P/R] Program/Run mode. Sets the calculator to Program mode (**PRGM** annunciator on) or Run mode (**PRGM** annunciator cleared) (**page 66**).

CLEAR [PRGM] In Program mode: clears all program memory and deallocates all program registers. In Run mode: only resets calculator to line 000 (**page 67**).

[MEM] Displays current status of calculator memory (number of registers dedicated to data storage, the common pool, and program memory) (**page 215**).

← Back arrow. In Program mode, deletes displayed instruction from program memory. All subsequent instructions are moved up (**page 83**).

LBL Label. Used with the label designations below to denote the start of a program routine (**page 67**).

A B C D E
 0 1 2 3 4 5 6 7 8 9 .0
 .1 .2 .3 .4 .5 .6 .7 .8 .9

Label designations. When preceded by **LBL**, define the beginning of a program routine (**page 67**). Also used (without **LBL**) to initiate execution of a specific routine (**page 69**).

USER Activates and deactivates User mode, which exchanges the primary (white) and gold alternate functions (**A** through **E**) of the top left five functions (**page 69**). User mode also affects the matrix use of **STO** or **RCL** {**A** through **E**, **(i)**} User mode automatically increments R_0 (row number) or R_1 (column

number) for storage or recall of matrix elements (**page 144**).

GTO Go to. Used with a label designator (listed above) or **I** to transfer the position of the calculator to the designated label. If it is a program instruction, program execution continues. If it is not a program instruction, only the position change occurs (**page 90**). If a negative number is stored in R_i , **GTO I** will effect a transfer to a *line number* (**page 109**).

GTO **CHS** *nnn* Go to line number. Positions calculator to the existing line number specified by *nnn*. Not programmable (**page 82**).

GSB Go to subroutine. Used with a label designator (listed above) or start the execution of a given, labeled routine. Can be used both in a program and from the keyboard (in Run mode). A **RTN** instruction transfers execution back to the first line following the **GSB** (**page 101**).

BST Back step. Moves calculator back one or more lines in program memory. (Also scrolls in Program mode.) Displays line number and contents of previous program line (**page 83**).

SST Single step. In Program mode: moves calculator forward one or more lines in program memory. In Run mode: displays and executes the current program line, then steps to next line to be executed (**page 82**).

PSE Pause. Halts program execution for about 1 second to display contents of X-register, then resumes execution (**page 68**).

R/S Run/Stop. Begins program execution from current line number in program memory. Stops execution if program is running (**page 68**).

RTN Return. Causes calculator to return to line 000 and halt execution (if running) (**page 68**). If in a subroutine, merely returns to line after **GSB** (**page 101**).

SF Set flag (= true). Sets designated flag (0 to 9). Flags 0 through 7 are user flags, flag 8 signifies Complex mode, and flag 9 signifies an overflow condition (**page 92**).

CF Clear flag (= false). Clears designated flag (0 to 9) (**page 92**).

F? Is flag set? Tests for designated flag. If set, program execution continues; if cleared, program execution skips one line before continuing (**page 92**).

x<y **x=0** **TEST** {0 through 9} Conditional tests. Each test compares value in X-register against 0 or value in Y-register as indicated. If true, calculator executes instruction in next line of program memory. If false, calculator skips one line in program memory before resuming execution (**page 91**). **x=0** and **TEST** 0, 5, and 6 are also valid for complex numbers and matrix descriptors (**pages 132, 174**).

- TEST** 0 $x \neq 0$
- TEST** 1 $x > 0$
- TEST** 2 $x < 0$
- TEST** 3 $x \geq 0$
- TEST** 4 $x \leq 0$
- TEST** 5 $x = y$
- TEST** 6 $x \neq y$
- TEST** 7 $x > y$
- TEST** 8 $x < y$
- TEST** 9 $x \geq y$

DSE Decrement and skip if equal to or less than. Decrements counter value in given register as stipulated. Skips one program line if new counter value is equal to or less than specified test value (**page 109**).

ISG Increment and skip if greater than. Increments counter value in given register as stipulated. Skips one program line if new counter value is greater than specified test value (**page 109**).

Subject Index

Page numbers in **bold** type indicate primary references; page numbers in regular type indicate secondary references.

A

Abbreviated key sequences, **78**

Absolute value (**ABS**), **24**

Allocating memory, 42, **213–219**

Altering program lines, **83**

Annunciators,

 complex, **121**

 list of, **60**

PRGM, 32, **66**

 trigonometric, **26**

Antilogarithms, common and natural, **28**

Arithmetic operation, **29**, 37

Asymptotes, horizontal, **230**

Automatic incrementing of row and column numbers, **143**

B

Back-stepping (**BST**), **83**

Bacterial population example, **41**

Battery life, 62, **259**, 263

Battery replacement, **260**

Bessel functions, **195**, 197

Branching,

 conditional, **91**, 98, 177, 192

 indirect, **108–109**, 112–114, 115

 simple, **90**

C

C annunciator, 99, **121**

Can volume and area example, **70–74**

Chain calculations, **22–23**, 38

282 Subject Index

Changing signs, **19**

in Complex mode, **124–125**

in matrices, **177**

[CHS], **19**

Clearing

blinking in display, **100**

complex numbers, **125–127**

display, **21**

memory, **63**

operations, **20–21**

overflow condition, **45, 61**

prefix keys, **19**

statistics registers, **49**

Coefficient matrix, **156**

Combinations function (**[C_y,x]**), **47**

Common pool, **213**

Complex arithmetic example, **132**

Complex conjugate, forming, **125**

Complex matrix,

inverting, **162, 164, 165**

multiplying, **162, 164, 166**

storing elements, **161**

transforming, **162, 164**

Complex mode, **120–121**

activating, **99, 120–121, 133**

deactivating, **121**

mathematics functions in, **131**

stack lift in, **124**

Complex numbers,

clearing, **125–127**

converting polar and rectangular forms, **133–135**

entering, **121, 127, 128–129**

storing and recalling, **130**

Conditionals, indirect, **109–111, 112, 116**

Conditional tests, **91, 98, 192**

in Complex mode, **132**

with matrix descriptors, **174**

- Constant matrix, **156**
- Constants,
 - calculations with, **39–42**
 - using in arithmetic calculations, 35, **39–42**
- Continuous Memory,
 - duration of, **62**
 - resetting (clearing), **63**
 - what it retains, 43, 48, 58, 61, **62**
- Conventions, handbook, **18**
- Conversions,
 - degrees and radians, **27**
 - polar and rectangular coordinates, **30–31**
 - time and angle, **26–27**
- Correcting accumulated statistics data, **52**
- Correlation coefficient, find the (\hat{y}, r) , **55–56**
- $\boxed{\text{COS}}$, $\boxed{\text{COS}^{-1}}$, **26**
- Counters in program loops, 98, **112–114**
- Crocus example, **43**
- Cumulative calculations, **41**

D

- Data storage, **42**
- Data storage pool, **213–214**
- Debt payment example, **95**
- Decimal point, 22
- Decimal point display, **61**
- Deflation, **233**, 234, 237
- $\boxed{\text{DEG}}$, **26**
- Determinant, 150
- Digit entry, 22
 - in Complex mode, **121**, 125, 127, **128–129**
 - termination, **22**, 36, **209**
- Digit separator display, **61**
- $\boxed{\text{DIM}}$, 76–77, **215–217**
- Disabling stack lift, **36**
- Display (*See also* X-register),
 - blinking, **100**
 - clearing, **21**
 - contrast, **63**, 270

284 Subject Index

error messages, **61**
full mantissa, **60**
in Complex mode, **121**
Display format, **58–59**, 61
effect on **f** **200**, 241, 244, **245–249**
Do if True rule, **92**, 192
DSE **109–111**, 112, 116

E

EEX, **19**
Electrical circuit example, **169–171**
Enabling stack lift, **36**
ENG, **59**
Engineering notation, **59**
ENTER, 12, **33–34**, 36
effect on digit entry, **22**, 29
effect on stack movement, **37**, 41
Entering data for statistical analysis, **49**
Error
conditions, **205–208**
display, **61**
stops, **78**
Errors,
with **$\int \frac{1}{x}$** , **203–204**
with **SOLVE**, **187**, 192, 193
Euclidean norm (See Frobenius norm)
Exchanging the real and imaginary stacks, **124**
Exponential function (See Power function)
Exponents, **19**, **20**

F

f, **18**
Factorial function (**$x!$**), **25**
Falling stone example, **14**
FIX, **58**
Fixed decimal notation, **58**
Flag tests, **92**, 98
Flag 8, **99**
Flag 9, **100**

Format, handbook, x, 18
 Fractional portion ($\boxed{\text{FRAC}}$), 24
 Frobenius norm, 150, 177
 Functions, nonprogrammable, 80
 Functions, one-number, 22, 25
 Functions, primary and alternate, 18
 Functions, two-number, 22, 29

G

$\boxed{\text{g}}$, 18
 Gamma function ($\boxed{\text{x!}}$), 25
 $\boxed{\text{GRD}}$, 26
 $\boxed{\text{GSB}}$, 101
 $\boxed{\text{GTO}}$, 90, 97, 98
 $\boxed{\text{GTO}}$ $\boxed{\text{CHS}}$, 82

H

Horner's Method, 79, 181
 Hyperbolic functions, 28

I

Imaginary stack,
 clearing the, 124
 creation of, 121–123, 133
 display of, 124
 stack lift of, 124
 Index register
 arithmetic, 108, 112
 display format control, 109, 114, 115, 116
 exchange with X-register, 108, 112
 flag control, 109, 115
 loop control, 107, 109–111
 storage and recall, 107, 111, 115
 Indirect addressing, 106–108, 115
 Initialization, 87
 Instructions, 74
 Integer portion ($\boxed{\text{INT}}$), 24
 Integrate function ($\boxed{\int \frac{1}{x}}$), 194–204
 accuracy of, 200–203, 240, 241–245

286 Subject Index

algorithm for, 196, **240–241**, 249–251, 255–256
display format with, **245–249**
execution time for, 196, **200**, 244, 245, **254–256**
memory usage, **204**
obtaining an approximation for, **257–258**
problems with erratic functions, **249–254**
programmed, **203–204**
recursive use of, **203**
subroutines for, **194–195**
uncertainty in, **202–203**, 240–244, **245–249**

Interchanging functions (See User mode)

Intermediate results, **22**, 38

Interpolation, using \hat{y}, r , **57**
ISG, **109–111**, 116

Iterations using **ISG** and **DSE**, **111**

K

Keycodes, **74–75**

Keying in

- chain calculations, **22**
- exponents, **19–20**
- one-number functions, **22**
- two-number functions, **22**, 29

L

Labels, **67**, **77**, 90, 97

LAST X register, **35**

- in matrix functions, **174–176**
- operations saved by, **212**
- putting constants in, **39–40**
- to correct statistics data, **52**

Linear equations, solving with matrices, **138**, 156

Linear estimation (\hat{y}, r), **55–56**

Linear regression (**L.R.**), **54**

Loading the stack with constants, 39, **41**

Logarithmic functions, common and natural, **28**

Loop control number, **109**, 116

Looping, **90**, 98

Low-power indication, 62, **259**

LU decomposition, **148**, 155, 156, 160
 Łukasiewicz, Jan, **32**

M

Mantissa, displaying full 10 digits, **60**

Matrix

- complex, **160–163**
- copying, **149**
- descriptors, 139, **147**, 160, in R_i , **173–174**
- dimensioning, **140**, 142, 174
- dimensions, displaying, **142**, 147
- equation, complex, **168**
- memory, **140**, 171
- name (See Matrix descriptors)
- partitioned, **161**, 164

Matrix elements,

- accessing individually, **145–147**
- displaying, **144**
- storing and recalling, **143–144**, 147, 149, 176

Matrix functions,

- using R_i , **173–174**
- using registers, **173**
- arithmetic, **153**
- conditional, **177**
- inverse, **150**, 154
- multiplication, **154**
- one-matrix, **149–151**
- programmed, **176–177**
- reciprocal, 150
- residual, **159**
- row norm, 150, **177**
- summary, **177–179**
- transpose, **150**, 151, 154

Mean (\bar{x}), **53**

MEM, **215**

Memory

- allocation, 76, **215–217**
- availability, 75–77, 213, **215**
- configuration, initial, **75–76**

288 Subject Index

distribution, 75, **213–214**
limitations, 75, 77, **217**
requirements for advanced functions, **218–219**
requirements for programming, **218**
stack (See Stack)
status display, **215**
registers in, **213–215**

Metal box dimensions example, **189–191**

Minima, finding with **[SOLVE]**, **230**

Modes, trigonometric, **26**

Multiple roots, **234**

N

Negative numbers, **19**

in Complex mode, **124–125**

Nested calculations, **38**

Neutral operations, **211**

Nonprogrammable functions, **80**

Normalizing statistics data, **50**

null display, **144**, 149

Numerical integration, **194–204**

O

[ON],

and off, **18**

to reset Continuous Memory, **63**

to set decimal point display, **61**

Overflow condition, 45, **61**, 100

P

[P/R], **66**, **68**

Pause (**[PSE]**), **68**

Percent difference (**[$\Delta\%$]**), **29**

Percentage functions, **29–30**

Permutations function (**[$P_{y,x}$]**), **47**

Phasor notation, 133

Pi, **24**

Polar coordinates, **30**, in Complex mode, **133–135**

Power function (**[y^x]**), **29**

Prefix keys, **19**

PRGM annunciator, **66, 82**

Program

control, indirect, 107, **109–111**

data entry techniques, **69–70**

end, **68, 77**

entering, **66–68**

labels, **67, 77**

loading, **66**

loop counters, **109, 112–114, 116**

mode, **66, 68, 86**

position, changing, **82, 86**

running, **68–69**

starting, **69**

stops, **68, 78**

Program execution, **69**

after **[GSB]**, **101**

after **[GTO]**, **97**

after overflow, **100**

after test, **92**

from or through labels, **78–79**

Program lines (instructions), **67, 74**

deleting, **83, 86**

inserting, **83, 86**

Program memory, 67, 70, **75, 217–219**

automatic real location, **217–218**

clearing, **67**

moving in, **67**

Q

Quadratic equation, solving, **181**

R

R_0 and R_1 , using to access matrix elements, 143, **146, 176**

[RAD], **26**

Radioisotope example, **93–94**

Random number generator (**[RAN#]**), **48**

Random number storage and recall, **48**

Recall arithmetic, **44**

290 Subject Index

Recalling accumulated statistics data, **50**
Recalling numbers ($\boxed{\text{RCL}}$), **42**, 44, with matrices, 144, 149, 176
Reciprocal ($\boxed{1/x}$), **25**, with matrix, 150
Rectangular coordinates, **31**, in Complex mode, **133–135**
Registers, converting, **215–217**
Reset calculator, **261**
Reset Continuous Memory, **63**
Residual, **159**
Result matrix, 147, **148**, 150, 152
Return ($\boxed{\text{RTN}}$), **68**, **77**
Returns, pending, **101**, 105, 192, 204
Reverse Polish Notation, **32**
 $\boxed{\text{Re}\angle\text{Im}}$ **124**, 127
Rice yield example, **50–56**
Ridget hurling example, **184–186**, 224–226
Roll down, **34**
Roll up, **34**
Roots, eliminating, **233**, 234, 237
Roots, meaningless, **188**, 191
Rounding ($\boxed{\text{RND}}$), **24**
Rounding in the display, **59**
Round-off errors, 52, **60**, with $\boxed{\text{SOLVE}}$, **223**, 237
Row norm, 150, **177**
Run/Stop ($\boxed{\text{R/S}}$), **68**, 91
running display, **69**, 147, 182

S

Scalar operations, **151–153**
 $\boxed{\text{SCI}}$, **58**
Scientific notation, **58**
Scrolling, **82**
Secant line calculation example, **102**
Self-tests, **261**
Service information, **263**
Shear stress example, **227–228**
 $\boxed{\text{SIN}}$, $\boxed{\text{SIN}^{-1}}$, **26**
Sine integral example, **198–199**
Single-stepping ($\boxed{\text{SST}}$), **82**, 85
Skip if True rule, **110**

Slope, finding the, **54****SOLVE**, **180–181**

- accuracy, **222–226**, specifying, **238**
- algorithm, 182, 187–188, **220–222**, 230–231
- conditions necessary for, **221–222**
- constant function value with, **187**, 189
- execution time, **238**
- illegal math routine with, **187–188**
- initial estimates with, 181, **188–192**, 221, 233, 237
- memory usage, **193**
- nonzero minimum of function with, **187**
- programmed, **192**
- recursive use of, **193**
- restrictions on, **193**
- using as a conditional test, **192**
- using functions with discontinuities, **227**
- using functions with poles, **227**
- using functions with several roots, **233–238**
- with no root, **186–188**, 192, 229

Square root (\sqrt{x}), **25**Squaring (x^2), **25**

Stack

- contents, with $\int \frac{1}{x}$, 197, **202**
- drop, **33**, 38
- lift, **33**, 36, 38, 44, **209–211**
- manipulation functions, **33–34**, in Complex mode, **131**
- imaginary, **120–125**
- used to access matrix elements, **146–147**

Stack-disabling operations, **210**Stack-enabling operations, **210–211**Stack movement, **32**, 33–37

- in matrix functions, **174–176**
- with **SOLVE**, **181**

Standard deviation (s), **53**, sample vs. population, **53**Star example, **40**Statistics, accumulation of data ($\Sigma+$), **49**Statistics, correction of accumulated data ($\Sigma-$), **52**Statistics functions,

- combinations, **47**

292 Subject Index

- correlation coefficient, **55**
 - linear estimation, **55**
 - linear regression, **54**
 - mean, **53**
 - permutations, **47**
 - probability, **47**
 - standard deviation, **53**
 - Statistics registers, **49–50**
 - Status indicators, **60**
 - Storage and recall ($\boxed{\text{STO}}$, $\boxed{\text{RCL}}$), **42, 43, 44**
 - complex numbers, **130**
 - direct (with $\boxed{\text{I}}$), 106, **107**
 - indirect, **106–107**, 111
 - matrices, **144**, 149, 176
 - matrix elements, **143–144**, 147, 149
 - Storage arithmetic, **43**
 - Storage registers, **42**
 - allocation, 42, **215–217**
 - arithmetic, **43**
 - clearing, **43**
 - statistics, 42, **49**
 - Subroutine
 - levels, **102**, 105
 - limits, **102**, 105
 - nesting example, **103**
 - returns, **101**, 105
 - using with $\boxed{\text{SOLVE}}$, **180–181**, 192
 - System flags, 92, **99**
-
- ## T
- T-register, 32, **33**
 - in matrix functions, **174–176**
 - with $\boxed{\int \frac{x}{y}}$, **202**
 - $\boxed{\text{TAN}}$ $\boxed{\text{TAN}^{-1}}$, **26**
 - $\boxed{\text{TEST}}$, **91**
 - Tracing, 82
 - Transpose, **150**, 151, 154
 - Trigonometric modes in Complex mode, **121**, 134
 - Trigonometric operations, **26**

U

- u display, **176**
- Uncommitted registers, 213, **215**, 217
- Underflow,
 - in any register, **61**
 - storage register arithmetic, **45**
 - with **SOLVE**, **223**
- User flags, **92**
- User mode, 69, **79**, with matrices, 143, **176**

V

- Vector arithmetic, using statistics functions, **57**

W

- Warranty information, **263**
- Wrapping, **86**, 90

X

- X exchange (**X↔**), **42**
- X exchange Y (**X↔Y**), **34**
- X-register, 32, 35, 37, 42, 60, **209–210**
 - imaginary, **210**, **211**
 - in matrix functions, 141, 156, **175–176**
 - with **↔_{xy}**, **202**
 - with **SOLVE**, 181, **183**, 192, 226

Y

- y-intercept, finding, **54**
- Y-register, 32, 37
 - in matrix functions, 141, 156, **175–176**
 - with **↔_{xy}**, **202**
 - with **SOLVE**, 181, **183**, 192, 226

Z

- Z-register, 32
 - in matrix functions, **174–176**
 - with **↔_{xy}**, **202**
 - with **SOLVE**, 181, **183**, 192, 226

The HP 15c Keyboard and Continuous Memory

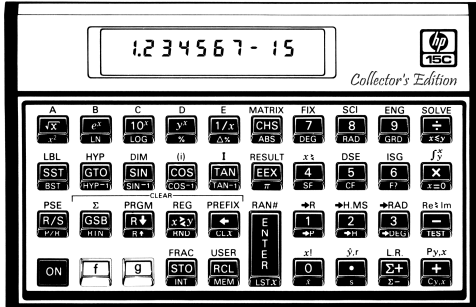

MEMORY STACK

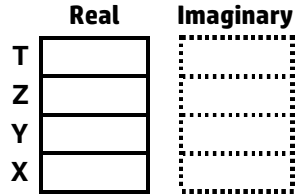

Display shows real X-register.

LAST X

DATA STORAGE POOL

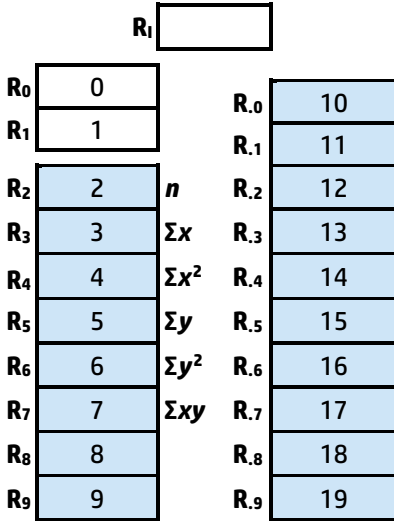

COMMON POOL

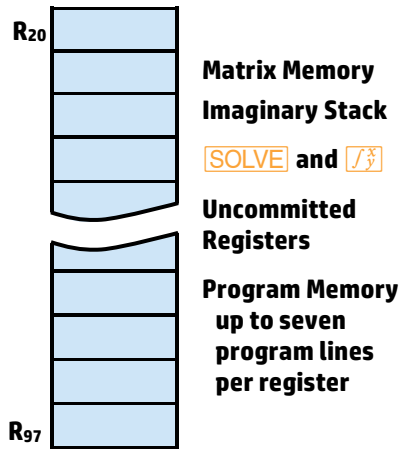

Initial allocation is R_0 through R_{19} to data storage.

Allocations can be changed with the **DIM** **(i)** function.

There are seven bytes of memory per register. One or two bytes are needed per program instruction. One register at a time is converted to program memory as needed, starting at the highest-numbered available register and proceeding to the lower registers.

Memory allocation for program lines is automatic *within* the common memory pool.

Initial allocation is R_{20} through R_{97} to the common pool, from which the above functions and programming draw space.

